

Radio-Electronics

FOR MEN WITH IDEAS IN ELECTRONICS

BUILD R-E's GRINCHWAL DIGITAL TEST EQUIPMENT

Self-Analysis Computer
FINDS CAR FAULTS FAST

In Solid-State Circuits
TRY YOUR CURVE TRACER

Color TV Is The Place
TO USE YOUR VECTORSCOPE

How They Work
SIGNAL GENERATORS

Lou Garner's
STATE OF SOLID-STATE

Bob Scott's
TECHNICAL TOPICS

Jack Darr's
TV SERVICE CLINIC



Pioneering again.....Castle presents a sensational NEW Timesaver for the Professional TV Service Technician..... Speed Testing by signal substitution. A new, simplified approach to signal circuit analyzing.....

TV TUNER SUBBER™



Transistorized Test Unit substitutes the tuner in defective TV Receiver to prove whether original tuner is good or bad. Performs tests normally made using elaborate and expensive signal generating equipment and oscilloscopes . . . but much more simply, with easily understood results. Tests that are, in fact, so simple that they can be made right in the home, in most cases without removing the tuner or chassis from cabinet.

Use with any 40MHz receiver . . . black and white or color . . . tube or transistor.

Completely self contained and battery operated; Mk. II, all solid state, improved version of original "subber." Uses L.E.D. indicator, has higher gain with wide range control affording more than 40db of gain reduction. Use on the bench or in the home . . . anywhere.

Substitutes the VHF tuner and tests the UHF tuner. Provides signal to simplify testing of tuner, i.f. system and AGC system. Comes complete with extension cables and instructions.

Unsolicited praise bestowed this revolutionary device includes:

" . . . works good. I know it will save hours in my TV Service . . . you are to be commended . . ."

" . . . in one month . . . TV Tuner Subber . . . already paid for itself — twice! Thanks much!"

" . . . received only Ch. 5, and not good. Used the new Castle TV Tuner Subber and got all channels . . . original tuner removed for service!"

TV TUNER SUBBER MK. II net \$31.95 Contact your distributor.

Include \$1.50 shipping and handling on prepaid mail orders: we will ship C.O.D.



CASTLE TV TUNER SERVICE, INC.

5715 N. Western Ave., Chicago, Illinois 60645 • Phone: (312) — 561-6354

Circle 1 on reader service card

GET "ON TARGET"

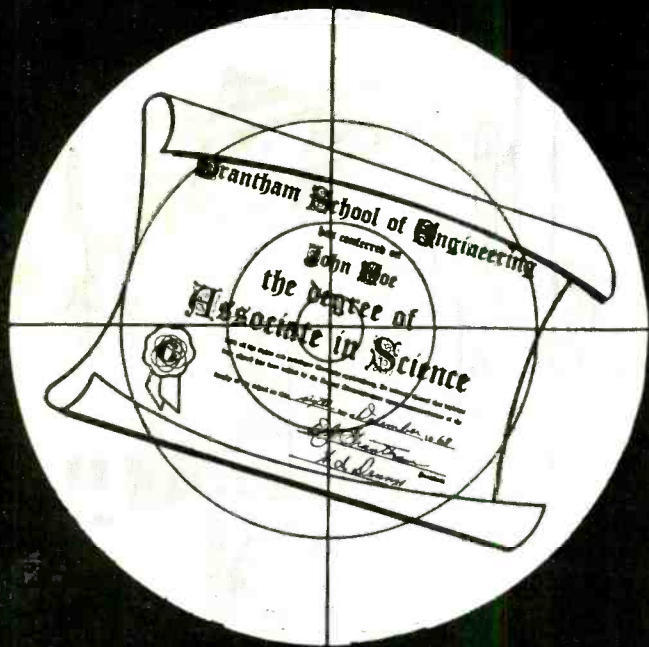

Get Your F.C.C. License and Your A. S. Degree

● Get Ahead in Electronics ●

*The Way to Get Ahead in Electronics is
To Get More Knowledge Into Your Head
And a Grantham Degree Into Your Pocket!*

Grantham School of Engineering

• Established in 1951 •



1505 N. Western Ave.
Hollywood, Calif. 90027

Telephone:
(213) 469-7878

If You Want To Get Ahead in Electronics, Get ON TARGET Now!

Are you planning your future or just drifting into it? Don't depend on luck; take aim. Prepare yourself for the future by getting plenty of "know how." Be ready to take advantage of opportunity when it knocks. Get more *real* education in electronics now.

GRANTHAM TRAINING PREPARES YOU

Grantham School of Engineering is a college-level institution, offering technical and engineering programs in electronics mainly by correspondence. The School is authorized (by the California Department of Education) to grant academic degrees, is approved under the G.I. Bill, and is accredited by the Accrediting Commission of the National Home Study Council.

You can advance your career in electronics mainly by

STUDYING AT HOME

for your F.C.C. license, and the Degree of Associate in Science in Engineering Technology—the A.S.E.T.—with a major in electronics. You prepare for your first class F.C.C. license in the first "correspondence semester," and earn your A.S.E.T. Degree in three more correspondence semesters plus a two-week seminar held at the School.

Grantham School of Engineering RE-11-72
1505 N. Western Ave., Hollywood, Calif. 90027

Please send me your free Bulletin which explains how the Grantham educational program can prepare me for a degree in electronics.

- I am a beginner in electronics.
 I am an electronics technician.

Name _____

Address _____

City _____ State _____ Zip _____

Circle 2 on reader service card

NOVEMBER 1972 • RADIO-ELECTRONICS 1

There's an Amperex replacement tube for any socket in any set you're likely to service...

TV, HiFi, FM or AM, House Radio, Car Radio,
P.A. System or Tape Recorder.
Imported or Domestic!



AMPEREX ELECTRONIC CORPORATION, DISTRIBUTOR SALES, HICKSVILLE, NEW YORK 11802

JACK DAVIS



AMPEREX SUPPORTS
THE INDEPENDENT
SERVICE DEALER

Amperex
TOMORROW'S THINKING IN TODAY'S PRODUCTS
A NORTH AMERICAN PHILIPS COMPANY

Radio-Electronics

FOR MEN WITH IDEAS IN ELECTRONICS

November 1972

TEST EQUIPMENT

- 26 **Equipment Report**
Heathkit IO-105 dual-trace triggered scope
- 41 **Using The Vectorscope**
How it works and some new ways to use it.
by Robert G. Middleton
- 54 **Equipment Report**
International Crystal FM-2400-CH frequency meter
- 55 **Generator Applications**
Nine ways to use an rf generator; also how to build a small portable unit. *by Jim Huffman*
- 62 **Using A Solid-State Curve Tracer**
A must "tool" for modern servicing; you have to understand it to use it effectively. *by Mannie Horowitz*

BUILD THIS ONE

- 33 **Grinchwal Digital Instruments**
One mainframe and several plug-ins form a complete digital test equipment system. *by Don Lancaster*

GENERAL ELECTRONICS

- 4 **Looking Ahead**
Tomorrow's news today. *by David Lachenbruch*
- 37 **VW's Self-Diagnosis Computer**
Built-in electronic monitoring plugs into a computer for a rapid and complete rundown of your car's performance.
by Fred W. Holder
- 45 **R-E Editors Earn CET Certificates**
- 52 **Technical Topics**
Unusual i.f. sweep generator, micropower on-off indicator, and versatile lab-power supply are among the subjects explored. *by Robert F. Scott*
- 59 **State Of Solid-State**
Telephone answering machines; a low-power drain semiconductor and several other new devices. *by Lou Garner*
- 88 **Appliance Clinic**
Technicians guide to the clothes dryer. *by Jack Darr*

TELEVISION

- 50 **Step-By-Step Troubleshooting**
Inside the sound modules. *by Art Margolis*
- 69 **Service Clinic**
Imagination, the technician's most important tool.
by Jack Darr
- 70 **Reader Questions**
R-E's Service Editor solves reader problems.

DEPARTMENTS

- | | |
|---------------------------|--------------------------------|
| 100 Circuits | 83 New Products |
| 16 Letters | 92 Next Month |
| 6 New & Timely | 111 Reader Service Card |
| 91 New Books | 95 Technotes |
| 86 New Literature | 90 Try This |

ON THE COVER

A GOOD PORTION of the R-E Digital Grinchwal System is shown on this month's front cover. You can see the mainframe, described in this issue, along with several plug-ins. For those who wonder how the picture was made, our photographer, Walter Herstatt set the plug-ins on the colored burlap background. He then placed a sheet of glass over the top of modules and positioned the main unit on the glass. This resulted in the floating in space look of the unit.



THE CURVE TRACER CAN BE VALUABLE to all who work in electronics. But first you must know how it works and what it can do. For a truly important article.....see page 63

Hugo Gernsback (1884-1967)
founder

M. Harvey Gernsback, editor-in-chief
and publisher

Larry Steckler, editor, CET

Robert F. Scott, W2P/WG technical editor, CET

Jack Darr, service editor

Louis E. Garner, Jr., semiconductor editor

I. Queen, editorial associate

Matthew Mandl, contributing editor

David Lachenbruch, contributing editor

James A. Gupton, Jr., photographic electronics

Vincent P. Cicentia, production manager

Nancy Gipson, production assistant

H. Matysko, circulation

Cover photograph by Walter Herstatt
Cover design by Marius Trinqu

Radio-Electronics is indexed in *Applied Science & Technology Index* and *Readers Guide to Periodical Literature*.

Radio-Electronics, November 1972, Vol. 43, No. 11 Published monthly by Gernsback Publications, Inc., 200 Park Avenue South, New York City 10003. Second-class postage paid at New York, N. Y. and additional mailing office. One-year subscription rate: U.S.A., U.S. possessions and Canada, \$7. Pan-American countries, \$8. Other countries, \$8.50. Single copies 60¢. ©1972 by Gernsback Publications, Inc. All rights reserved. Printed in U.S.A.

Subscription Service: Mail all subscription orders, changes, correspondence and Postmaster Notices of undelivered copies (Form 3579) to Radio-Electronics Subscription Service, Boulder, Colo. 80302.



looking ahead

An LP videodisc

A new development in the videoplayer field has the television industry buzzing, and there are some predictions that it could be as revolutionary as color TV. Whodunit? RCA. At press time, RCA was making no comment except to concede that the development did indeed exist and that our description was substantially correct.

RCA has quietly been demonstrating to a few select television set manufacturers and others in the TV industry a long-playing color videodisc system that is said to use an inexpensive player and low-cost conventional-appearing records. We have not seen the device, nor has any representative of the press. But we have talked with enough qualified engineers (none from RCA) who have witnessed a demonstration to feel that it is of major significance as a potential new home product.

What RCA is demonstrating to the select few is a device that resembles a conventional phonograph, plays 12-inch discs, but is attached to a color TV set and is capable of playing 20 minutes of color picture plus stereo sound from each side of the disc—a total of 40 minutes for both sides. It is a playback-only device and cannot make recordings. **Radio-Electronics** readers learned about the German-British color videodisc developed by A.E.G. Telefunken and Decca in last December's issue. It is a major technical achievement, using a cushion of air to suspend a flexible disc, that whirls at 1800 rpm and uses a specially designed "pressure stylus" to read out the picture. A single disc will play for five minutes.

What is dramatic about RCA's development is its differences from the Telefunken-Decca system and its similarities to standard audio disc

equipment. It spins at 400 to 500 rpm, and apparently uses the traditional needle-in-groove pickup system. The discs are rigid, rather than flexible, and are pressed in the conventional record-pressing manner. Those who have witnessed RCA's demonstration were impressed with picture, color and sound. The eventual retail price of the playing equipment is expected to be somewhere under \$400—perhaps far under—with discs costing less than a dollar for material and pressing. This compares with \$35 or more for an hour's worth of blank video tape.

Although RCA's system is still in the developmental stage, the target date for marketing is understood to be late 1974, which will also mark the tenth anniversary of the start of work on the system at the RCA Laboratories in Princeton, N.J. What is the secret? Nobody is saying. But in this day of sophisticated computer memories, it would be ironic indeed if the phonograph disc—an invention of the 19th century—turned out to be the most practical information-storage medium.

Smaller uhf band?

Under federal law, all television sets manufactured must be able to tune all 70 channels from 2 through 83. But in 1970, the FCC turned over the top 14 uhf channels—69 through 83—to the land-mobile radio services. The only broadcast facilities still occupying these upper channels are about 800 low-powered translators, that have been given FCC permission to move to lower frequencies. Television set manufacturers, through the Electronic Industries Association, now have petitioned the FCC to cut the knot once and for all, lopping the top 14 channels from the TV broad-

cast band and relieving them of the responsibility to build sets which can adequately tune to stations which aren't there. The EIA argues that reducing the size of the uhf band would make it easier to build tuners and help improve tuning accuracy by reducing the compromises needed to span the huge uhf band with one tuning instrument.

Cable TV's growth

More than 10% of the nation's homes are now receiving television by cable, according to figures in the latest issue of *Television Factbook*, which keeps track of such things. As of the start of this year, the publication's statistics show, 6 million homes were connected to cable systems, an increase of 700,000 during 1971. On March 31, 1972, there were 2,839 CATV systems in operation, the average system serving 2,272 subscribers. Fewer than half of the existing systems merely supply subscribers with programs picked up from TV stations, and 594 originate their own programming—live, film and/or videotape. An additional 920 have "automatic originations" only—channels served by automatic time and weather reports, news tickers and the like. Some 210 systems insert commercials in their own programming. The country's largest systems are in San Diego, with 65,000 subscribers as of March 31; New York City, 45,000; Northampton, Pa., 45,000; a second New York system with 43,000; Altoona, Pa., 42,500, and Allentown, Pa., 38,275.

It's no accident that Pennsylvania is so heavily represented among the largest systems—that's where CATV started, as a means for bringing clear reception to cities in areas where mountains made it impossible to receive satis-

factory direct off-the-air television.

It adds up

Soon everybody will have one and manual arithmetic will be obsolete. Or so it seems, with prices on electronic calculators dropping like autumn leaves. The pocket calculator has now moved into the home product category, as the result of rather startling prices. As little as a year ago, \$200 or \$220 was a bargain price for a calculator. Today, thanks to a single-chip MOS, calculators are coming within the range of housewives and students.

American, not Japanese, manufacturers have taken the lead in bringing calculator prices down into the consumer-product range. Bowmar Instrument Corp., the biggest manufacturer, has sold about 250,000 pocket units with LED readouts, with a list price of \$179. North American Rockwell has been making units with liquid-crystal readout designed to sell at about \$100. Texas Instruments, which makes the MOS chip, has a pocket unit at \$150 and will soon introduce a desk-top model at about \$85. The Japanese, whose prices on calculators has been higher than those of the lowest-priced U.S.-made models, have now begun to fight back. Sharp, probably the leading Japanese calculator manufacturer, is readying an under-\$100 model for the American market. But the lowest price yet is from Casio of Japan, which has introduced a six-digit model on the American market at under \$60 retail. The same unit sells in Japan at less than \$42. Next year it's forecast that some pocket calculators will be available at less than \$50 in the United States.

by DAVID LACHENBRUCH
CONTRIBUTING EDITOR

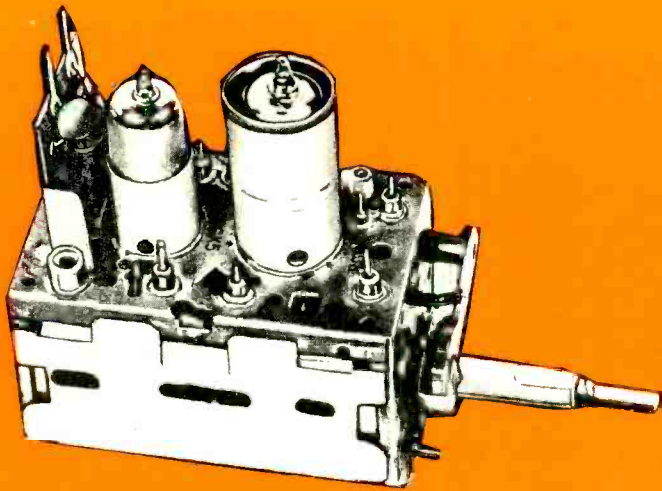

\$9.75

ALL PARTS
INCLUDED

ONE YEAR GUARANTEE

TUNER SERVICE CORPORATION

PROVIDES YOU WITH A
COMPLETE SERVICE FOR
ALL YOUR TELEVISION
TUNER REQUIREMENTS.

REPAIR

VHF Or UHF Any Type \$9.75.
UHF/VHF Combo \$15.00.

In this price all parts are included.
Tubes, transistors, diodes, and nuvistors are
charged at cost.

Fast efficient service at our 5 con-
veniently located service centers.

All tuners are cleaned inside and out,
repaired, realigned and air tested.

REPLACE

Replacement Tuner \$9.75.

This price buys you a complete new
tuner built specifically by SARKES TARZIAN
INC. for this purpose.

All shafts have a maximum length of
12" which can be cut to 1½".

Specify heater type parallel and series
450mA or 600mA.

CUSTOMIZE

Customized tuners are available at a
cost of only \$15.95.

Send in your original tuner for com-
parison purposes to:



TUNER SERVICE CORPORATION

FACTORY

TUNER SERVICE

Backed by the largest tuner manufacturer in the U.S.—Sarkes Tarzian, Inc.

INDIANA	537 S. WALNUT ST., Bloomington, Indiana 47401	TEL:812-332-7251
	817 N. PENNSYLVANIA ST., Indianapolis, Indiana (Headquarters)	TEL:317-632-3493
NEW JERSEY	547-49 TONNELE AVE., Jersey City, New Jersey (On U.S. Highway 1 & 9)	TEL:201-792-3730
VIRGINIA	4538 PRINCESS ANNE ROAD, Norfolk, Virginia	TEL:703-855-2518
KENTUCKY	2920 TAYLOR BLVD., Louisville, Kentucky 40208	TEL:502-634-3334
GEORGIA	938 GORDON ST., S. W., Atlanta, Georgia	TEL:404-758-2232
FLORIDA	1505 CYPRESS ST., Tampa, Florida 33606	TEL:813-253-0324
CALIFORNIA	SARKES TARZIAN, INC., TUNER SERVICE DIVISION 10654 MAGNOLIA BLVD., North Hollywood, California	TEL:213-769-2720

WATCH US GROW

Circle 3 on reader service card

new & timely

Lithium tantalate crystals to improve communications

A new man-made crystal, now in production at Western Electric's Merrimack Valley Works in Massachusetts, the first practical alternative to quartz for use in communications equipment, may improve and simplify crystal filters. It may also find use as a light modulator and as a detector of infrared light frequencies.

Piezoelectric crystals (crystals that deform under an applied voltage and that produce a voltage when stressed mechanically) are widely used as filters in communications equipment. The bandwidth of quartz crystals, heretofore the universal material for crystal filters, is limited by a weak electromechanical coupling characteristic; its efficiency in converting mechanical to electrical energy or the reverse is not as high as might be desired.



CRYSTAL MAKERS AT WORK—Albert Ballman of Bell Laboratories and David Rudd of Western Electric Co., with the crystal pulling machine.

Lithium tantalate has an electromechanical coupling constant five or six times better than that of quartz, according to Albert Ballman of Bell Laboratories, who developed the new crystal. Its temperature-frequency characteristic compares favorably with that of quartz, and it has low impedance, high Q, minimum coupling to unwanted modes, good machinability and low water solubility.

"Minified" X-ray pictures possible with new technique

A new minification system that permits taking pictures of the whole human body on a single piece of standard X-ray film has been announced by the Medical Electronics Operation of the Raytheon Co., Waltham, Mass. This will make faster and more accurate diagnoses possible.

The equipment provides for two minification levels: 5-to-1 for whole-body scanning and 2-to-1 for individual organs.

In the 5-to-1 mode, two passes of the scanner take full-size views of right or left lateral or of back or front, plus minified whole-body views. In the 2-to-1 mode, substantial film savings are possible; it is necessary to load film into cassettes only once instead of four times to obtain a complete photo record.



NANCY BRACKETT, former Miss Massachusetts, holds a film demonstrating the new X-ray technique.

The system is completely compatible with the company's single and dual-head nuclear scanners and is available as optional equipment.

Practical superconductivity with new cryogenic material?

Superconductivity has been reported at temperatures above 20° Kelvin (-254° C) by researchers at the RCA laboratories in Princeton, N.J. This research may make superconductive electric motors, generators and transmission lines possible. The material that retains its su-



Dr. GEORGE W. WEBB, ACHIEVER of the breakthrough in cryogenic research, continues to search for higher temperature superconductors.

perconductivity at these "high" temperatures is a compound of niobium and gallium.

A superconductor, produced by cooling a metal to a temperature near absolute zero, has no resistance. Thus it can carry practically unlimited amounts of current. Unfortunately, a slight increase in temperature destroys superconductivity, as does a magnetic field above a certain strength.

Superconductivity has in the past been obtained only a very low (cryogenic) temperatures—a few degrees above absolute zero. Cooling to such low temperatures is expensive—the new material may make a cost reduction of 75% possible.

The new compound not only retains its superconductivity at relatively high temperatures, but also in magnetic fields far stronger than is possible with other superconducting materials.

It is possible that practical niobium-gallium superconductive systems can be made to operate efficiently in magnetic fields greater than 100 kilogauss and at temperatures higher than 14° K. That temperature can be reached with liquid hydrogen refrigeration, instead of the much more costly helium refrigeration required for lower temperatures.

Experiments with superconducting transmission lines have already been made, and a variety of applications may become practical with the new, more economical, approach to superconductivity.

Communications Technologist Honored



Dr. Eugene O'Neil (left in the photograph) has been awarded the 1971 IEEE Award in International Communications. Among the outstanding contributions to the communications field for which he was cited are technologies developed for the first operational Telstar communications satellite and transoceanic cable.

(continued on page 12)



Our town

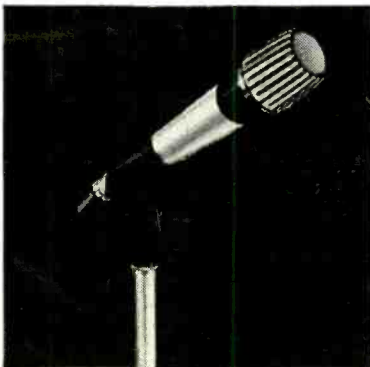

The sun never sets in our town, nor do our microphones and sound systems get any rest. "Our town" is the mecca for sound specialists, and here, Shure Microphones and Vocal Master Sound Systems handle it all: you'll hear them in hotel show rooms and lounges used by famous professional entertainers whose livelihoods depend on sound excellence; you'll hear them in hotel convention halls, in club after club, in casino after casino; and you'll hear them 'round-the-clock as keno scores are announced. Why? Because the predictability and reliability of Shure microphones and sound systems simply make everyone's job a lot easier. The Shure sound is the Las Vegas sound — and we're proud of it.

Shure Brothers Inc.,
222 Hartrey Ave., Evanston, Ill. 60204.



Circle 4 on reader service card

NOVEMBER 1972 • RADIO-ELECTRONICS 7



firsts

make learning
Electronics at home
fast and fascinating—
give you priceless
confidence.

Some NRI **firsts** in training equipment



first to give solid state 25" color TV, 5" wide band oscilloscope, color bar generator and other professional equipment engineered specifically for education. You work directly on the receiver as you build it, discovering the practical aspects of TV servicing as you create a handsome new color console. Only NRI includes an attractive woodgrain cabinet without extra charge.



first to give you a unique, exciting digital computer *with memory* built especially for home training. You learn organization, trouble shooting, operation, programming as you build and use it. Performs the same functions as commercial computers. Lessons stress computer repair. You conduct a hundred experiments, build hundreds of circuits. A solid-state VTVM is included among ten training kits.

NRI's "discovery" method is the result of over half a century of leadership simplifying and dramatizing training at home

The FIRSTS described below are typical of NRI's half century of leadership in Electronics home training. When you enroll as an NRI student, you can be sure of gaining the in-demand technical knowledge and the priceless confidence of "hands-on" experience sought by employers in Communications, Television-Radio Servicing and Industrial and Military Electronics. Everything about NRI training is designed for your education . . . from the much-copied, educator-acclaimed Achievement Kit sent the day you enroll, to "bite-size" well-illustrated, easy to read texts programmed with designed-for-learning training equipment.

YOU GET YOUR FCC LICENSE OR YOUR MONEY BACK

There is no end of opportunity for the trained man in Electronics. You can earn \$6 or more an hour in spare time, have a business of your own or qualify quickly for career positions in business, industry, government. And if you enroll for any of five NRI courses in Communications, NRI prepares you for your FCC License exams. *You must pass* or NRI refunds your tuition in full. No school offers a more liberal money-back agreement. The full story about NRI leadership in Electronics training is in the new NRI Catalog. Mail postage-free card today. No salesman is going to call.

NATIONAL RADIO INSTITUTE, Washington, D.C. 20016 (In Canada write: NRI Rep., 330 Progress Ave., Scarborough, Ont.)

APPROVED UNDER NEW GI BILL If you have served since January 31, 1955, or are in service, check GI line on postage-free card.

designed from chassis up for your education

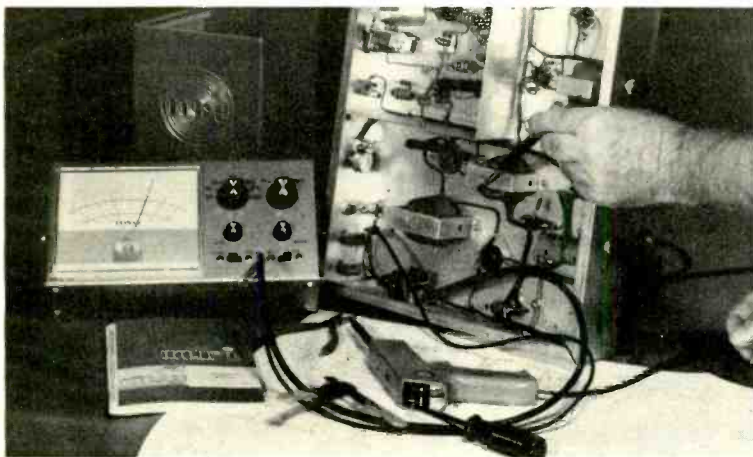

first to give you true-to-life experiences as a communications technician. Every fascinating step you take in NRI Communications training, including circuit analysis of your own 25-watt, phone/cw transmitter, is engineered to help you prove theory and later apply it on the job. Studio equipment operation and troubleshooting become a matter of easily remembered logic.



first to give you completely specialized training kits engineered for business, industrial and military Electronics. Shown above is your own training center in solid state motor control and analog computer servo-mechanisms. Telemetry circuits, solid-state multi-vibrators, and problem-solving digital computer circuits are also included in your course.

You don't have to get a college in electronics

Next to a willingness to work, nothing will improve your chances of success in electronics more than a college-level education. But family obligations and the demands of your job may make it very difficult for you to attend classes. That doesn't mean you have to forget about getting ahead. CREI makes it possible for you to get the college-level education you need without going back to school.

Learn at home

At your own pace, your own schedule . . . without giving up your present job. CREI lessons are written to be clearly understood without the presence of a teacher. Your problems are anticipated. Your instructors will work with you in a very personal manner and give you all the individual attention you need. Many men learn far more readily through home study than they ever did in the classroom.

Not for beginners

CREI programs are written for men familiar with basic electronics, but who want to

get the advanced, specialized knowledge they must have to move up to engineering-level positions and engineering-level pay. All CREI training material is developed with the help of top engineers and scientists from private industry and government laboratories. Each of these men is an expert in his field of electronics. He knows exactly what level of specialized knowledge a man needs to work successfully in that particular field today. This is your assurance that what you learn from your CREI study can be applied on the job.

You can have confidence in CREI

Since 1927, CREI has helped tens of thousands of men move ahead in every phase of the electronics industry. You'll find CREI graduates and students in key jobs wherever up-to-date knowledge of electronics is demanded. Leading companies recognize the quality of CREI education. Many pay all or part of CREI tuition for their employees.

CREI education is up-to-date education

CREI courses are continually being revised. New developments are included as quickly as they occur. Right

now, CREI students are getting the latest information on cable TV, LSI chips, microminiaturization, lasers and masers, telemetry systems, servomechanisms and data links. If it's new in electronics, CREI—and you—will know about it.

Send for free book with complete information on CREI programs

Use postpaid card—no stamp needed. If card is detached use coupon or write: CREI, Dept. E 1411C, 3939 Wisconsin Ave., N.W., Washington, D.C. 20016

CREI Founded 1927
Accredited Member of
the National
Home Study Council

to go to college -level education

Capital Radio Engineering Institute

This certifies that
Robert Dewey, Jr.
 has satisfactorily completed the Course of Study in
Electronic Engineering Technology
 Majoring in
Computers
 and upon the recommendation of the Board of Directors is granted this
Diploma
 In Testimony Whereof, we have affixed our signatures

B. A. Costello

**CREI, A Division of the McGraw-Hill
 Continuing Education Company**

Dept. E 1411C, 3939 Wisconsin Ave, N.W.,
 Washington, D.C. 20016

Please send me free book with full information about
 CREI Programs.

Name _____ Age _____
 Address _____
 City _____ State _____ Zip _____
 Employed by _____
 Type of Present Work _____

- I am interested in: Computers Electronic Engineering
 Technology Nuclear Engineering Technology
Industrial Electronics Electronics Systems
 Engineering Television Engineering Non-Technical
 Course in Computer Programming New! Cable TV

APPROVED FOR TRAINING UNDER NEW GI BILL

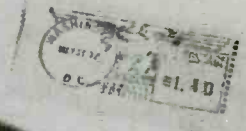

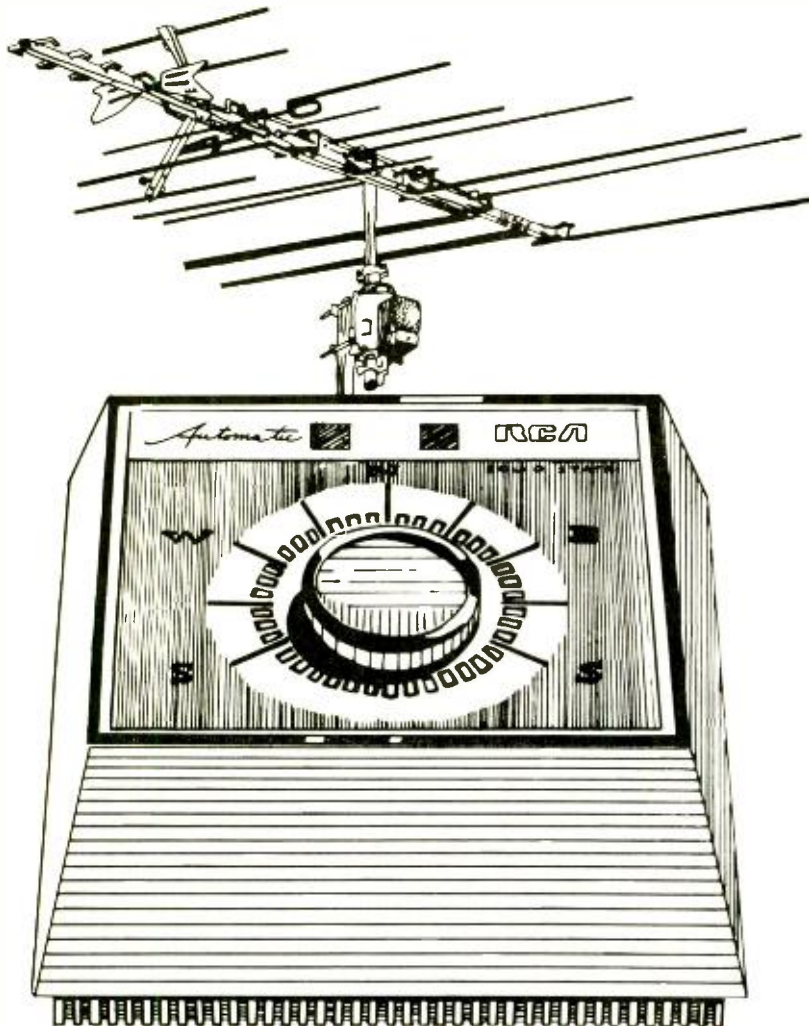

Give them the picture they paid for with RCA antennas and rotators.

A great combination for great reception—and great sales. Because you cover all reception requirements... UHF, VHF/FM or UHF-VHF combinations... color or black-and-white... metropolitan or fringe areas... with the full line of RCA Permacolor antennas and RCA rotators. Each Permacolor antenna is precision engineered, easy-to-install—a top quality performer. Every RCA rotator features dynamic turning power and pin-point accuracy. Plus handsome styling for maximum customer appeal. And RCA antennas and rotators were developed with the space age techniques and thorough testing that have made the RCA name famous.

So give your customers the picture they paid for with the name they can rely on... RCA. The extra feature that means more sales for you. At your RCA Parts and Accessories distributor.

Parts and Accessories, Deptford, New Jersey 08096

Circle 10 on reader service card

LETTERS

(continued from page 16)

"discrete" RCA-JVC record in practical playback situations. In SQ, the Lf and Rf signals are totally separated throughout the encode-decode process, while in the RCA-JVC, *demodulation* of the ultrasonic carriers followed by *dematrixing* must take place to separate Lf and Rf signals for 4-channel listening.

PETER SCHEIBER
New York, N.Y.

A "BETTER" IC OP-AMP

Referring to the article "Op-Amps At Work Using The 709" by B. R. Rogen in *Radio-Electronics*, September 1972.

It would be a disservice to your readers not to mention the "741" second generation op-amp (RCA, CA3741, Motorola MC1741). The 741 is a direct replacement for the 709 and requires no external frequency compensation, is output short circuit proof. It is also "latch-up" free and has a maximum of ± 30 volts (with a power supply voltage of ± 15 vdc) differential input signal range.

JAMES GUILBEAU
New Orleans, La.

R-E



The elderly person
in a nursing home. The woman
who must spend Christmas

in the hospital,
away from her family.

The serviceman
far from home
on Christmas Day.

All get a touch
of holiday happiness
from The Salvation Army.

Your gift
makes it possible.

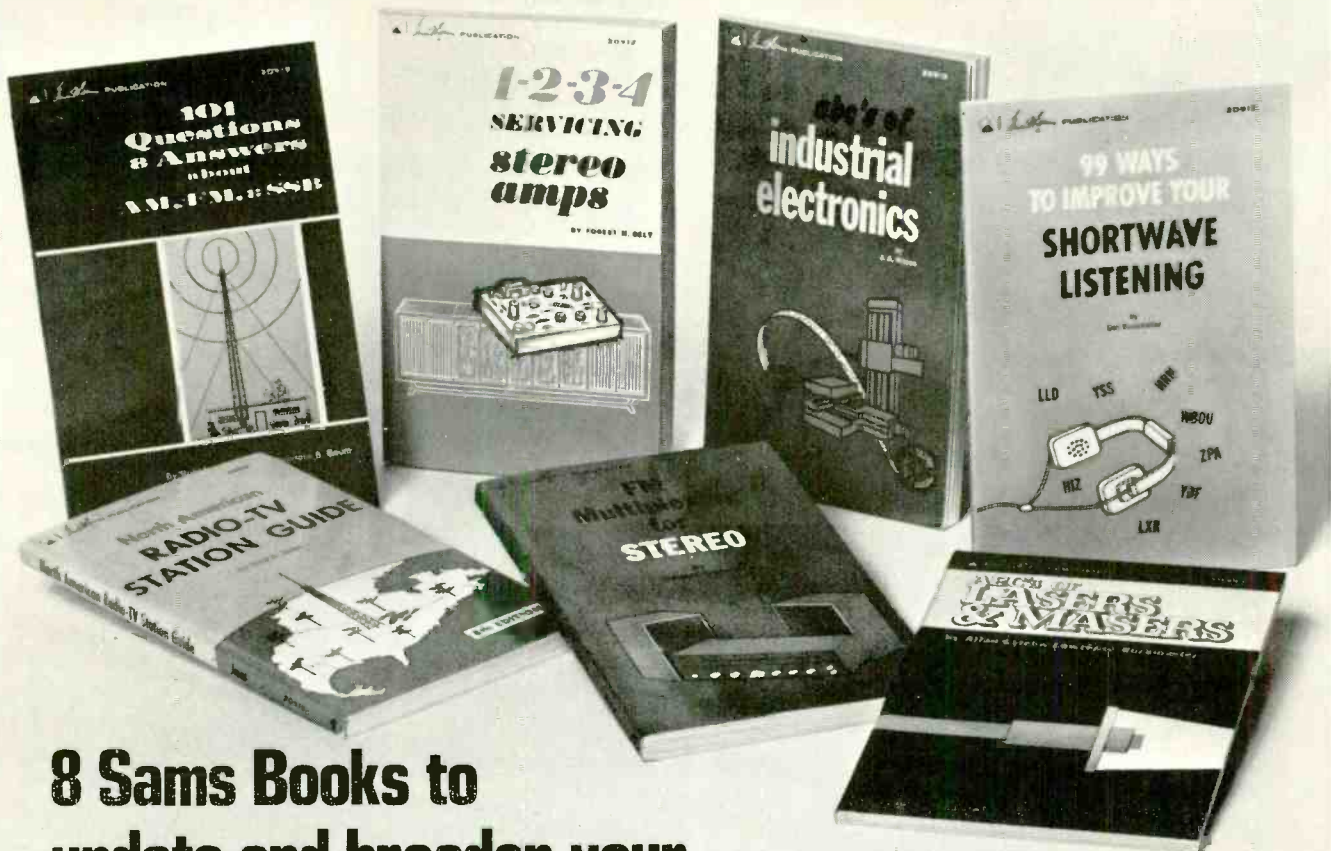

8 Sams Books to update and broaden your Electronics Skills

Three are newly revised editions . . . 5 are brand new this fall . . . all will be valuable additions to your library.

ABC'S OF LASERS AND MASERS (3rd Edition)
By Allan Lytel and Lawrence Buckmaster
The completely updated explanation and review of the development and applications of lasers and masers in measurements, communications, medical surgery, and industrial usages; 128 pages; 5½" x 8½"; softbound.
No. 20863 \$3.50

99 WAYS TO IMPROVE YOUR SHORTWAVE LISTENING (NEW)
By Len Buckwalter
A valuable source of information for both hobbyist and experienced technician. Includes: antennas and installation, receiver improvements, accessories, interference sources, troubleshooting tips, listening techniques. 144 pages; 5½" x 8½"; softbound.
No. 20911 \$3.95

101 QUESTIONS AND ANSWERS ABOUT AM, FM, & SSB (NEW)
By Leo G. Sands
Easy-to-understand information about the three basic modulation techniques and the various types of transmission. Describes best uses, technical aspects and limitations of each in a Q&A format. 96 pages; 5½" x 8½"; softbound.
No. 20919 \$3.95

1-2-3-4 SERVICING STEREO AMPS (NEW)
By Forest H. Belt
Details the "divide and conquer" method of troubleshooting and servicing stereo equipment and shows how to apply the method for best results. Many illustrations and schematics in this clear, easy-to-read manual. 240 pages; 5½" x 8½"; softbound.
No. 20912 \$4.95

NORTH AMERICAN RADIO-TV STATION GUIDE (8th Edition)
by Vane A. Jones
Lists nearly 10,000 a-m, fm and television stations in the U.S., Canada, Mexico, and the West Indies. Includes: power (day and night), antenna height, and time sharing. Arranged by geographical location, frequency (or channel), and call letters. 160 pages; 5½" x 8½"; softbound.
No. 20915 \$3.95

ABC'S OF INDUSTRIAL ELECTRONICS (NEW)
By J. A. Wilson
Covers the circuits and applications of electronics used in manufacturing, together with all types of electronics systems that are not designed for home entertainment. Tells and shows how electronics have improved on old-time methods of machine and process controls. 96 pages; 5½" x 8½"; softbound.
No. 20913 \$3.95

FM MULTIPLEXING FOR STEREO (3rd Edition)
By Leonard Feldman
Analyzes the fm stereo signal; gives requirements for fm stereo receiver; covers multiplex decoder circuit variety and servicing, stereo indicator lights and automatic stereo switching; test equipment and alignment procedures. 176 pages; 5½" x 8½"; softbound.
No. 20910 \$4.95

MARINE SINGLE SIDEBAND (NEW, NOT SHOWN)
By Donald M. Stoner and Pierre B. Goral
Fills a void in published literature on the subject of Marine Single Sideband, the method by which all marine electronic voice communications must soon be carried out. Covers all facets of Single Sideband in marine communications. 192 pages; 5½" x 8½"; softbound.
No. 24029 \$5.95

HOWARD W. SAMS & CO., INC.
4300 West 62nd Street, Indianapolis, Indiana 46268.

Order from your Electronics Parts Distributor, or mail to Howard W. Sams & Co., Inc.

Send books checked at right. \$_____ enclosed.
Please include sales tax where applicable.
Canadian prices slightly higher.

20863 20915
 20911 20913
 20919 20910
 Send Free 1972 Sams Book Catalog. 20912 24029

Name _____
Address _____
City _____ State _____ Zip _____

RE112

Circle 11 on reader service card

USE IT ALL AT HOME AS YOU GET READY FOR A NEW CAREER!

\$1,500.00 worth of two-way radio electronic communications equipment!

Bell & Howell Schools announces a new learn-at-home program that gives you "hands on" experience with commercial-grade equipment – as you prepare for a business of your own in two-way radio electronic communications servicing.

You *need* "hands on" experience with a real, commercial-band FM transceiver and actual commercial-grade test equipment – to take full advantage of growing opportunities in electronic communications.

Two-way radio communications is a healthy growth area in electronics. And it's lucrative. Almost two million commercial two-way radio systems now serve as vital communications links for trucks, planes, boats and taxis. And the FCC requires each system to have its equipment serviced regularly by a licensed technician. That's where *you* come in. But you need career-oriented training – plus your FCC license.

Knowing how to put an amateur radio kit together won't help when you're "on the job" – servicing two-way radio systems for aircraft or advising trucking companies about their land-mobile communications system. For that, you need "hands on" experience with the real thing. This unique new Bell & Howell Schools learn-at-home program gives you just that. You can work with the equipment by attending one of our special "help sessions" or by dropping by one of the Bell & Howell resident schools. If neither of these plans is convenient, you can have the equipment shipped to your home in return for a deposit, which is refundable when you return the equipment.

Find out more about this exciting new Bell & Howell Schools program. There's no obligation.

**For free facts,
cut out and mail coupon today!**



Let Bell & Howell Schools help you get ready for an exciting career or business of your own in two-way radio electronic communications!

Bell & Howell Schools has helped many thousands of people prepare for careers — and businesses of their own — in electronics. You can have absolute confidence in the training you get.

Expert instructors at Bell & Howell Schools plan each program to answer a single question: "What qualifications will you need to take advantage of *actual career opportunities* in electronics?" They then build each program to give you those exact qualifications.

To get ready for a business of your own in two-way radio, you need: 1) career-oriented training; 2) FCC License; 3) "hands on" experience with commercial-grade equipment. Bell & Howell Schools now offers this new at-home training program that gives you all three. (See FCC License Guarantee below.)

Just look at all the equipment you'll work with — right at home — during your training program with Bell & Howell Schools!

Commercial-Band FM Transceiver ... exactly the kind of two-way radio you'll service throughout your career.

Deviation Meter ... model favored by many working technicians to check modulation of transmitted signal.

Frequency Meter ... highly sensitive instrument used to check signal frequency within precise tolerances established by government standards.

Power Output Meter ... meter used almost universally by trained and licensed technicians to check power output — or wattage — of signal.

Alignment Generator ... a custom-designed unit you use to generate test signals for transceiver alignment.

FCC regulations give you the opportunity to start your own business!

The Federal Communications Commission requires that all commercial two-way communications systems be checked and serviced by a licensed technician at regular intervals.

As a Bell & Howell Schools graduate, you'll have the technical know-how you need. With your FCC license, you can go out and eventually build your own business — signing contracts with companies that use two-way radio. FCC regulations could mean security and regular income for you!

Bell & Howell Schools offers you these special advantages:

Help Sessions Scheduled regularly every few Saturdays at the Bell & Howell Schools and in many other cities throughout the U.S. and Canada. Top instructors give you personal help and guidance.

Transfer Privileges After completion, you can transfer to any of the resident schools for more advanced

study, if you wish.

Lifetime National Placement Assistance Helps you locate a job where you want to anytime after you complete program.

Veterans' Benefits We are approved by the state approval agency for Veterans' Benefits.

Student Financial Aid We are an eligible institution under the Federally Insured Student Loan Program.

Exclusive Electro-Lab — yours to keep!

To make sure you get practical experience with instruments used daily by professionals, we've integrated into your program three precision instrument kits you assemble yourself and keep!

Design Console Use this to rapidly "breadboard" circuits without soldering.

Oscilloscope Offers bright, sharp screen images, 3-way jacks for leads, plugs.

Transistorized Meter Registers current, voltage and resistance.

Guarantee

Obtaining a commercial radio-telephone license from the FCC is necessary for many jobs in two-way and broadcast communications. Bell & Howell Schools guarantees that if after the successful completion of this course, including a supervised final exam, you take and fail to pass the First Class license exam, we will offer at no additional charge the tutoring necessary to enable you to pass the exam. This help may take the form of special lessons at home, attendance at a Help Session, or special assistance at one of our resident schools (in this case you would be responsible only for travel and living expenses). If you accept the help, then take the exam and are still unable to pass the First Class license, a complete refund will be made of all tuition paid. This guarantee is good only if the student first takes the exam within six months of completing the course and takes a re-exam within six months of completing the review course. If he fails, he must advise Bell & Howell Schools within 30 days of receiving his notice of failure and follow the tutoring program suggested by the school.

For free information, mail coupon today! or write:

DEVRY INSTITUTE OF TECHNOLOGY
ONE OF THE



BELL & HOWELL SCHOOLS

4141 Belmont Avenue, Chicago, Illinois 60641

403

Bell & Howell Schools, 4141 Belmont Avenue, Chicago, Illinois 60641



OKAY...

Please send me free information about the \$1,500.00 worth of two-way radio electronic communications equipment I use in my own home as I prepare for a new career in two-way radio.

NAME _____ (please print)

ADDRESS _____

CITY _____ STATE _____ ZIP _____

TELEPHONE _____ AGE _____

Check here for information about: Veterans' Benefits Student Financial Aid

MD2N

DISTORTION-TEST AUDIO EQUIPMENT

- *easily*
- *quickly*
- *accurately*

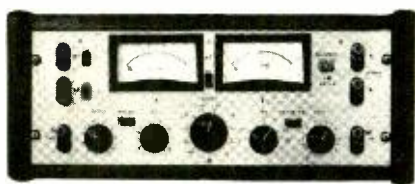

Now the TECRON IMA makes measuring IM distortion even easier than measuring THD!

Just one piece of equipment has both internal oscillators and inter-modulation distortion analyzer. Simply connect the oscillator output to the input of the test unit, and hook the unit's output to the input of the analyzer. One quick set up, then switch a single control to simultaneously adjust input and output levels. Take up to ten power level measurements in 5db steps in just 60 seconds! Readings over a wide span of output levels fully describe the distortion characteristics of the test unit.

The IMA itself has a guaranteed residual IMD of less than 0.005% (typically under 0.003%). There are seven IM ranges with accuracy assured to within 5% of full scale (+0.005% on the 0.1 full scale range).

As all other TECRON laboratory instruments, the IMA is of advanced design, ruggedly constructed from highest quality components by skilled American craftsmen.

Product literature is free upon request. For a technical discussion on the advantages of using IM testing to detect audible distortion, send 25¢ for A.E.S. Preprint No. 871 (B-9) to Crown International, Box 1000, Elkhart, Indiana, 46514, U.S.A.

Full input and output metering; also full input and output monitoring oscilloscope terminals ■ solid state construction, utilizing FETs for stability and compact size (7" x 19" x 7") ■ full complement of level controls ■ two internal oscillators eliminate the need for additional test equipment ■ rack mount list price \$570, with walnut cabinet \$595

Made Only in America



TECRON

Circle 12 on reader service card

equipment report

*Heathkit IO-105
triggered-sweep
dual-trace scope*

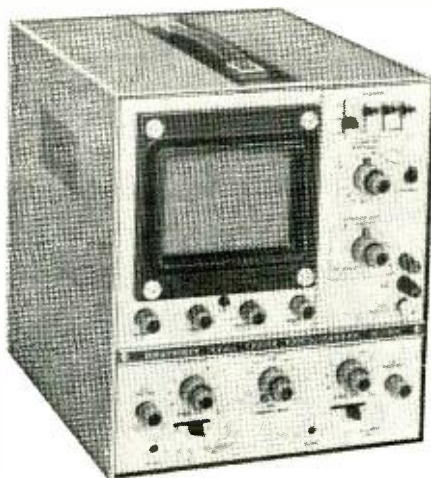

Circle 100 on reader service card

OLDTIMERS WILL REMEMBER THAT ONE of the first Heathkits marketed some 25 years ago was a low-priced oscilloscope. The IO-105, Heath's latest, is a far cry from that instrument. It is probably the first oscilloscope kit to incorporate many features found only in laboratory instruments of considerably higher price. Like its lower priced cousin the IO-103 (*Radio-Electronics*, June, 1972), it is an all solid-state triggered-sweep instrument. However, as a study of its specifications will show, it is a good deal more sophisticated than the IO-103 and, therefore, can be used in many more applications, either in design work or on the service bench.

The dual-trace feature is a tremendous advantage in many kinds of design or service work since it permits the user to display two separate input signals side by side for direct comparison. Or one of the channels can be used to display an input signal while the other is displaying the same signal after it has passed through the piece of equipment being tested. A common time base is used for both the channel 1 and channel 2 amplifiers. When displaying two channels simultaneously, the user has a choice of two different modes of operations: *alternate* or *chopped*. In the alter-

nate mode, the two signals are displayed alternately on successive sweeps. Of course, as the sweep speed is increased, the two signal traces seem to appear simultaneously. In the chopped mode, the two signals are sampled at a rate of 50 kHz.

A third mode: X-Y, displays channel 1 on the vertical (Y) axis and channel 2 on the horizontal (X) axis. This mode is useful when making input-output linearity comparisons, studying phase shifts and for displaying Lissajous patterns.

The channel 1 and 2 amplifier circuits contain identical wide-band amplifiers with a response from dc to 15 MHz with a variation of 3 dB. The rise time is 24 ns with an overshoot of less than 10%.

Both channels have 9-position attenuators in a 1, 2, 5 sequence providing a range from 50 mV/cm to 20 volts/cm. In addition, each channel has an uncalibrated variable gain control which can be used for vernier gain adjustments. The input impedance of each amplifier is 1 megohm shunted by 35 pF. Either ac or dc coupling is switch selectable.

Sweep circuits

The horizontal time base has 18 calibrated rates ranging from .2 μ s/cm to 100 ms/cm in 1, 2, 5 sequence. Sweep accuracy is $\pm 3\%$. There is also a continuously variable uncalibrated sweep speed control. In addition, a panel push button provides a sweep magnification of 5 times.

The calibrated time base makes it possible to measure the frequency of any input signal within the frequency or voltage ranges of the instrument. This is one of the great advantages of a triggered sweep scope with a calibrated time base. Charts are provided in the instruction book for converting the TIME/CM selector switch settings to frequency. And the triggered sweep, of course, makes it easy to lock into a signal of any frequency for measurement or observation. Four triggering switches give great flexibility. The first selects either external, line or internal triggering; the second provides for ac or dc triggering. The third is for triggering either on
(continued on page 87)



FREE

send today for the all-new

Olson

1973 CATALOG

NOW the only catalog offering a wide selection of the best of **THE FAMOUS ELECTRONIC BRANDS** plus the exclusive Olson values!



save now on everything in electronics

YOUR COMPLETE BUYING GUIDE

Big! Beautiful (many full-color pages)! Value-packed! Your one dependable source for everything in audio and electronics. Enjoy every buying advantage at Olson: low money-saving prices, fastest shipment, personal service, satisfaction guaranteed or money back.

Olson Exclusive Values

Besides the best of the famous brands you'll find 100's of money-saving items sold only by Olson. See our all-new TELEDYNE stereo line, recorders & radios, parts bargains.

- Stereo components & the newest in 4-channel
- Tape recorders & recording accessories
- Radios & phonographs of all kinds
- Money-saving do-it-yourself kits
- Auto electronics & accessories
- Citizens Band two-way radios
- VHF & UHF police/fire monitors
- Amateur radio station equipment
- Public address & intercom systems
- Test Gear • Parts bargains
- Electronic security equipment
- TV-FM antennas & accessories
- Books, tools, hardware, parts
- Batteries, transistors, tubes, wire, cable, & more!

FREE



MAIL COUPON NOW

OLSON ELECTRONICS Dept. LZ 260 S. Forge St., Akron, Ohio 44327

Rush FREE 1973 Olson catalogs to:

Name _____ Apt. _____

Address _____

City _____

State _____ Zip _____

Name _____ Apt. _____

Address _____

City _____

State _____ Zip _____

*more of the best
of everything
in electronics*

Olson Electronics
where the values are!

Circle 13 on reader service card

learn by doing!

Perform more than 200 exciting experiments with CIE's fascinating **ELECTRONICS LABORATORY PROGRAM!**

Put theory... into practice



You get your own 161-piece electronics laboratory... with authentic electronic components used by industry!

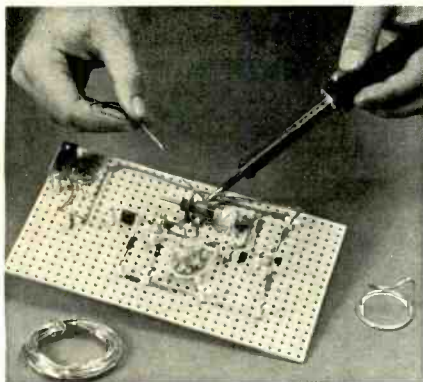

You learn how to construct circuits and connect them with a soldering iron, which is part of your CIE laboratory equipment. This "hands on" experience is extremely valuable in applying what you learn.

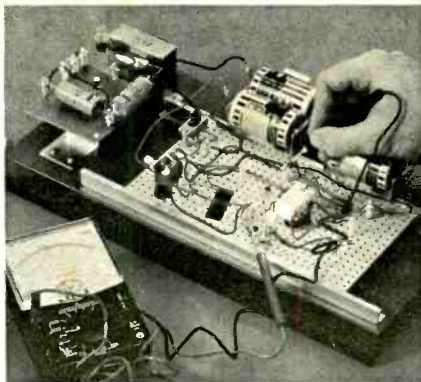

Testing and troubleshooting are an important part of your learning experience. Included in your laboratory is a precision "multimeter" to diagnose electrical and electronic troubles quickly and accurately.

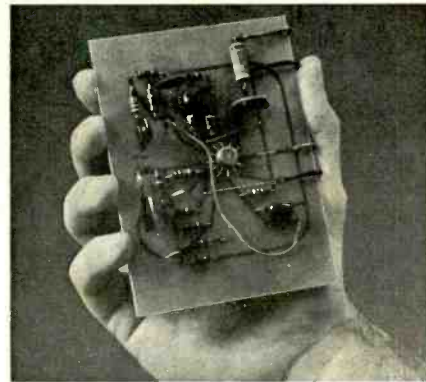

Modern space-age components like this IC (integrated circuit) are professional quality and can be used again and again in many of your projects. Lesson by lesson, piece by piece your knowledge grows!

Prepare now for a high income career in Electronics...the Science of the Seventies.

Electronic miracles are changing today's world with breathtaking speed.

And with this growth in electronics technology has come a brand new need... a demand for thousands of electronics technicians, trained in theory and practice to build the products, operate them and service them during the Seventies.

Don't just wait for something to "happen" in your present job. Get ready now for a career you'll really enjoy with a good income and plenty of opportunity for advancement.

Experience with experiments is your best teacher

"Hands on" experience helps to reinforce basic theory. When you learn by doing, you discover the "how" as well as the "why." You'll find out for yourself the right way as well as the wrong way to use electronic components. How to construct your own circuits, to discover trouble spots and learn how to fix them. And with CIE's special Auto-Programmed® Lessons, you learn faster and easier than you'd believe possible.

CIE's fascinating course, Electronics Technology with Laboratory, teaches you Electronics by making it work before your eyes. And you do it yourself, with your own hands.

Importance of FCC License and our Money-Back Warranty

Many important jobs require an FCC License and you must pass a Government licensing exam to get one.

But, a recent survey of 787 CIE graduates reveals that better than 9 out of 10 CIE grads passed the FCC License exam.

That's why we can offer this famous Money-Back Warranty: when

you complete our Laboratory Course, which provides FCC License preparation, you'll be able to pass your FCC exam or be entitled to a full refund of all tuition paid. This warranty is valid during the completion time allowed for your course.

You get your FCC License — or your money back!

You'll have high paying job opportunities

Electronics is still young and growing. In nearly every one of the new exciting fields of the Seventies you find electronics skills and knowledge are in demand. Computers and data processing. Air traffic control. Medical technology. Pollution control. Broadcasting and communications. With a CIE Diploma and an FCC License you can choose the career field you want... work for a big corporation, a small company or even go into business for yourself.

Here's how two outstanding CIE students carved out new careers: After his CIE training, Edward J. Dulaney, President of D & A Manu-

facturing, Inc., Scottsbluff, Nebraska, moved from TV repairman to lab technician to radio station chief engineer to manufacturer of electronic equipment with annual sales of more than \$500,000. Ed Dulaney says, "While studying with CIE, I learned the electronics theories that made my present business possible."

Marvin Hutchens, Woodbridge, Virginia, says: "I was surprised at the relevancy of the CIE course to actual working conditions. I'm now servicing two-way radio systems in the Greater Washington area. My earnings have increased \$3,000. I bought a new home for my family and I feel more financially secure than ever before."

Send now for 2 FREE BOOKS

Mail the reply card or coupon for our school catalog *plus* a special book on how to get your FCC License. For your convenience, we will try to have a representative call. If coupon is missing, write: Cleveland Institute of Electronics, Inc., 1776 E. 17th St., Cleveland, Ohio 44114. Do it now!



Approved
under
G.I. Bill

All CIE career courses are approved for educational benefits under the G.I. Bill. If you are a Veteran or in service now, check box for G.I. Bill information.

CIE Cleveland Institute of Electronics, Inc.
1776 East 17th Street, Cleveland, Ohio 44114
Accredited Member National Home Study Council

Please send me your two FREE books:

1. Your illustrated school catalog, "Succeed in Electronics."
2. Your book, "How to Get a Commercial FCC License."

I am especially interested in: Electronics Technology with Laboratory
 Electronics Technology Industrial Electronics
 Electronic Communications First Class FCC License
 Broadcast Engineering Electronics Engineering

Name _____ Age _____
(PLEASE PRINT)

Address _____

City _____ State _____ Zip _____

Veterans and Servicemen: Check here for G.I. Bill information.

RE-10

Circle 14 on reader service card

NOVEMBER 1972 • RADIO-ELECTRONICS 31

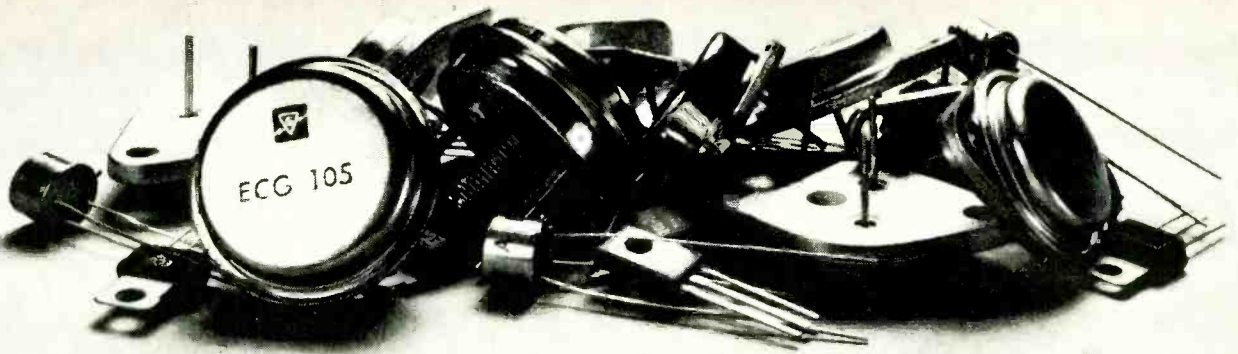

Our 39 audio power transistors replace...

To Be Replaced	ECG Replacement	To Be Replaced	ECG Replacement
AD138	121	QP 1A	173
AD138/50	121	QP 2	173
AD139	704	QP 3	173
AD140	121	QP 4	173
AD142	179	QP 5	179
AD143	179	QP 6	179
AD143B	179	QP 7	179
AD148	131	QP 8	130
AD149	104	QP 8 1	130
AD149-01	121	QP 8 P	130
AD149 02	121	QP 10	179
AD149B	121	QP 11	130
AD150	121	QP-12	130
AD152	131	QP-13	185
AD155	131	QP-14	184
AD156	131	QP8-6623N	105
AD157	131	QP-13	153
AD159	121	QP-14	152
AD160	175	QOC61209	158
AD161	155	QOC61210	102A

and thousands more.

There are a lot of identical transistors around hiding under different manufacturers' part numbers.

But we've boiled power transistors down to just 39 types that will handle almost all of your replacement problems.

And we've also put together a cross-reference guide that tells you which one replaces which.

Our cross-reference guide also tells you about the rest of our ECG replacement semiconductor line. Altogether they can substitute for 53,000 others.

Practically everything from diodes to integrated circuits.

And we don't stop there.

The ECG semiconductor line includes a variety of heat sinks, heat-sink compounds, transistor mounting kits, and sockets.

In short, carrying Sylvania's ECG replacement semiconductor line can take a big load off your back.

And you can still give power to the people.

Sylvania Electronic Components,
Waltham, Mass. 02154.

GTE SYLVANIA

The foundation or mainframe of a group of useful and inexpensive digital test instruments for the lab, service shop and experimenters' workbench. Accessories plug into the readout.



BUILD R-E's GRINCHWAL DIGITAL TEST EQUIPMENT

by DON LANCASTER

VIRTUALLY EVERY DIGITAL INSTRUMENT needs an accurate internal time or frequency reference. For instance, an electronic digital counter needs 0.1-, 1-, and 10-second time gates, while an electronic stopwatch may need a source of 10-microsecond wide time period pulses, or a digital voltmeter may need a stable source of 100-kHz timing signals for *dual-slope integration*, used for accurate voltage to frequency conversion. This internal reference is usually called a *time base*.

One cheap time base is the power line, but it's hard to use in a battery-powered instrument and it doesn't have enough accuracy or stability to do justice to 4 decades of counting. So, traditionally, you had to go to a crystal oscillator and a bunch of current-hogging RTL or TTL decade dividers.

The digital grinchwal* does things differently. It starts with a crystal all right, but it uses a *single* integrated circuit that will give you any time or frequency reference you ask it to, from 1 MHz to 1 pulse per hour! To make things even nicer, the integrated circuit only draws 5 mA.

Figure 1 is a block diagram of the

*grinchwal, *n.* (originated by author): gizmo, gadget, thingamajig. The digital readout and timebase of a multi-purpose test instrument featuring plug-in modules for various functions or operations.

Mostek MK5009 time-base integrated circuit. You hang a 1-MHz crystal and some biasing and trimming components on its internal oscillator. You then send it a four-line code command that tells it how much to divide by, and out comes a reference frequency or time period that talks to the grinchwal counter or that can drive an ordinary RTL, DTL, or TTL integrated circuit. To program the IC to a desired division ratio, you use the code of Table 1. There are four input lines, called A, B, C, and D. A digital "0" is equal to ground, while a digital "1" is at or near the +6-volt supply. For instance, if you start with a 1-MHz crystal, and apply the code 0101, or A = 1, B = 0, C = 1 and D = 0, the IC divides by five decades, or 10^5 , giving you either a 10-hertz output signal or a 100-millisecond period square wave. Accuracy to four decades can be obtained by trimming the crystal against WWV or another frequency reference, but even without any trimming you get a very stable and very accurate output.

You also get a *reset* input. Ground it and the IC runs normally. Make it 6 volts positive and the chip puts all its dividers in the 0 state. This is handy to *gate* your reference frequency for things like electronic stopwatches and sports timers. The reset and counters are syn-

chronous. This means the first output cycle will be within a millionth of a second of the width of all the rest of the cycles.

There are several precautions in using this chip. Never apply reverse supply voltage or you will instantly zap it. Also, the unused inputs must be connected exactly as shown in Fig. 2, for the IC has some internal-test speedup modes it can get into if you, say, try to use -12 volts instead of ground for a logic "0". Note the 1-MHz direct output is too fast for the MK5005 counter and display plug-in, and thus can only be used on external circuits. With the addition of resistor R1, the two chips can talk to each other at any other reference time or frequency. And, like any other MOS device, an exceptionally unreasonable amount of mishandling can damage the chip, so leave it in its conductive foam carrier until after you have checked all the rest of your circuit out; then quickly and carefully solder it in place with a small soldering *IRON* (No guns please) and fine solder.

Building the mainframe

The schematic is in Fig. 2. Circuit boards, complete kits, and any and all parts are available from the source shown in the parts list. The grinchwal is

built in an unbreakable impact plastic case $5 \times 6\frac{1}{2} \times 2\frac{1}{2}$ inches deep. The power supply or the batteries mount in the upper bottom of the case, underneath a main PC board that contains the timebase and connector for the plug-ins and the counter module. A front panel covers the top half of the case, supporting a red filter for the display module, the CHECK and RESET pushbuttons and the OVERFLOW indicator. Besides the timebase and connectors, the PC board contains some supply filtering and reverse-polarity protection, a pulser for the reset line, a driver for the overflow indicator, and a "relay" (Q2, Q3) to control the -12-volt supply.

The PC board is shown in Fig. 3. You can get this commercially or etch and drill your own, using this pattern. All the components except IC1 may be mounted in place, watching the polarity on all the capacitors and diodes. A small four-wire flat cable makes the front panel connections neater, but plain old wire can be used. Note that the overflow indicator, being a light emitting diode is polarity sensitive. Be sure to connect it exactly as shown in the schematic with the narrow pin going to the IND terminal and the wide pin going to ground. Don't add IC1 till after the preliminary checkout.

You have a choice of batteries or a line-operated power supply. The battery supply—for maximum portability—consists of two 9-volt transistor radio batteries and four type C cells (alkaline for long life) connected as in Fig. 4-a. Note that the + terminal of the 18-volt battery goes to the + terminal of the 6-volt battery, *not* to ground! Use the line-operated supply in Fig. 4-b if you don't really need extreme portability and like to leave test instruments on for long periods of time. If you want to use *both* a power supply and larger batteries or rechargeable batteries, you'll probably want to go to a somewhat larger case. A two-transistor and transformer inverter may be used to convert the +6 volts to -12 volts if you want to do away with the two 9-volt batteries.

Whatever route you pick, the power source mounts under the main PC board, leaving the bottom half of the case open for the plug-ins. Power needs are 6 volts at 125 mA and -12 at 5 mA.

Using the mainframe

We'll be showing you several plug-ins from time to time, but if you're designing your own modules, the following guidelines should be of some help.

The power ON-OFF switch goes between +6 volts and +6SW. With the

Q2, Q3 relay it also controls -12 volts. The decimal-point selector goes between DP IN and the chosen DP1, DP10, DP100, or DP1K. If you don't connect it or else connect it to DP1, you'll get just a number displayed with all three left-hand zeros lopped off. If you can arrange things so you get a "0" reading between measurements, this will radically extend the battery life.

The timebase is activated by switching a "1" (+6 volts) and a "0" (ground) to inputs A, B, C, and D following the truth table of Table 1. The timebase OUT terminal may be connected directly to the COUNT terminal of the counter/display, or else it will drive one TTL or DTL input. You reset the timebase by putting +6 volts on the normally grounded RST line.

The COUNT input may be connected to a RTL, DTL, or TTL output in your plug-in, to the timebase output, or to +5 volts through a capacitor. It free runs (self-oscillates) with the capacitor and follows the counting with either the timebase or your external low-impedance logic source. UPDATE

will follow the counting if grounded and keep the old count if at +6 volts. Reset for the count module forces the counter to zero if it is grounded. If you push the RESET button, you get a brief pulse going to ground on this terminal every time you hit the button. You can use this for a resetting signal for your plug in. Note that the resets of the counter and timebase are backwards in action. If you decide to reset both at once, you need an inverter to ground the counter while applying +6 volts to the timebase. RESET only resets the counter, not the display. To get a 0000 reading, you have to simultaneously reset and update the counter module.

The OVERFLOW output goes to ground on count 10,000 and stays there until reset. It may be directly connected to the IND input to light the overflow lamp, or it will drive one logic load in your plug-in. If you want to independently light the overflow indicator, you ground the IND input instead of connecting it to the OVERFLOW output on the counter module. A ground lights the lamp; +6 volts puts it out.

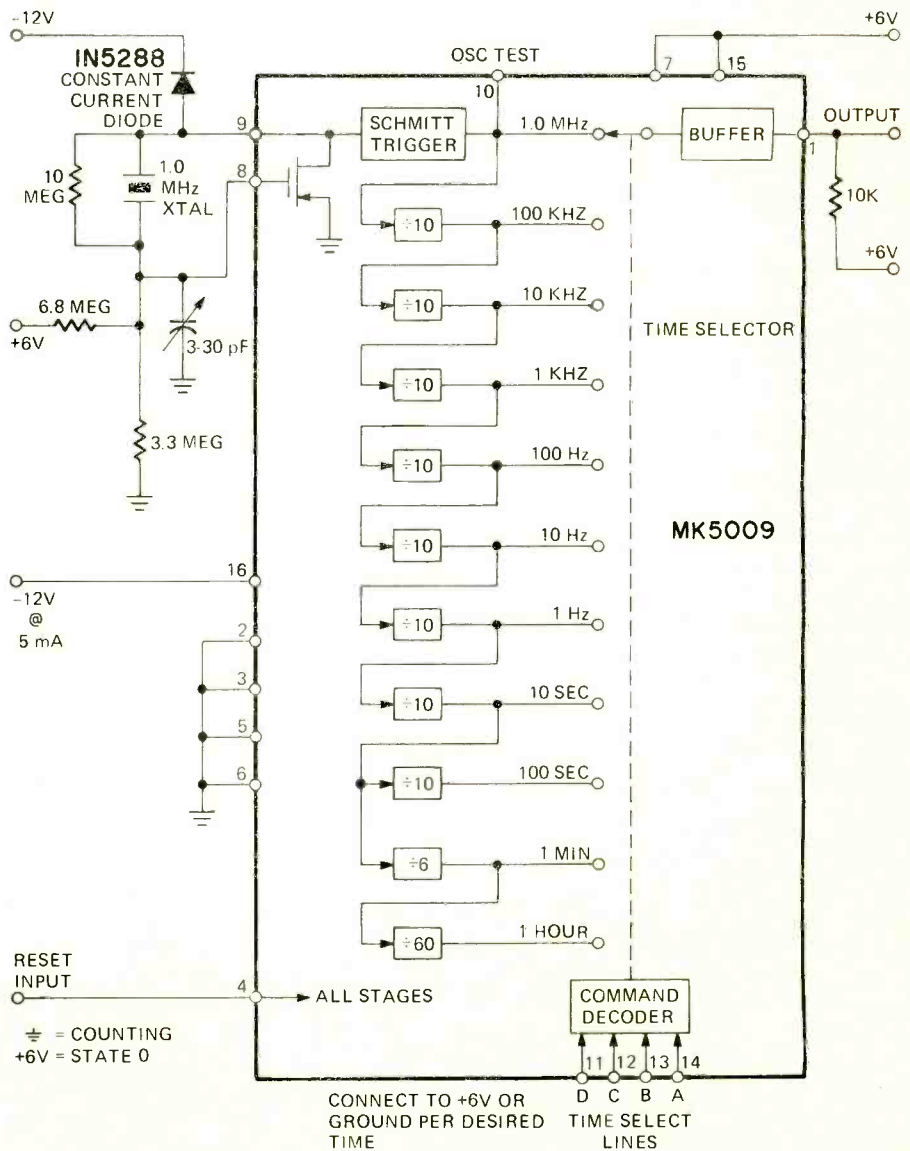

FIG. 1—BLOCK DIAGRAM of the time-base IC and the basic circuitry. This and the digital readout form the heart of several test instruments.

PARTS LIST

- C1—3-30 pF trimmer capacitor
- C2—5 pF mica capacitor—optional; needed only with certain crystals
- C3, C5, C7—0.1 μ F, 10-volts disc ceramic capacitor
- C4—47 μ F, 15-volt electrolytic
- C6—220 μ F, 6-volt electrolytic
- D1, D2—1N914 diode
- D3—D6—1N4001 diode
- D7—1N5288 constant-current diode **DO NOT SUBSTITUTE**
- IC1—MK5009P time base IC (Mostek), special design built for Don Lancaster projects.
- LM1—MV5023 LED panel lamp or equivalent
- S1,2—Spst momentary pushbutton
- Q1,2—2N5139 transistor, silicon pnp
- Q3—2N5129 transistor, silicon npn
- R1,6,8—10K, 1/4 watt carbon resistor
- R2—2.2 megohm carbon resistor
- R3—6.8 megohm, carbon resistor
- R4—3.3 megohm carbon resistor
- R5—1 megohm carbon resistor
- R7—330 ohm carbon resistor
- R9—4.7K, carbon resistor
- SO1—4—10 pin chassis mounting socket, Molex 09-52-3103
- XTAL 1—1.00 MHz crystal and mounting clip

MISC: PC Board per Fig. 3, plastic case; 9-volt battery clips (2); spacer foam for batteries; Dual C holders (2); front panel; red filter; mounting hardware: wire; solder.

NOTE: The following are available from Southwest Technical Products, 219 West Rhapsody, San Antonio, Texas, 78216: PC Board, etched and drilled No. DGM-b, \$4.85 postpaid. Circuit board for readouts, No. DGR-b, \$3.85 postpaid. Kit of parts for readout, No. DR-C, \$34.50. Kit of parts for mainframe and timebase plug-in, including case and front panel, No. DM-C, \$26.75, less readouts and batteries, postpaid.

POWER SUPPLY PARTS LIST

- C1—5000 μ F, 10 V electrolytic
- C2, 3—500 μ F, 25 V electrolytic
- D1, D2, D3, D4—1N5061 silicon power diode, 1 A to piv
- D5—12-V Zener diode, 1N4742 or equivalent
- F1—0.1 A fuse and fuseholder
- IC1—6-V positive regulator, Fairchild 7806
- R1—27 ohms, 1/4 watt
- T1—12.6 Vct, 100 mA transformer (Signal PC 12-100 or equal)

MISC: PC Board for power supply, line cord; PC terminals (Optional) (5); solder.

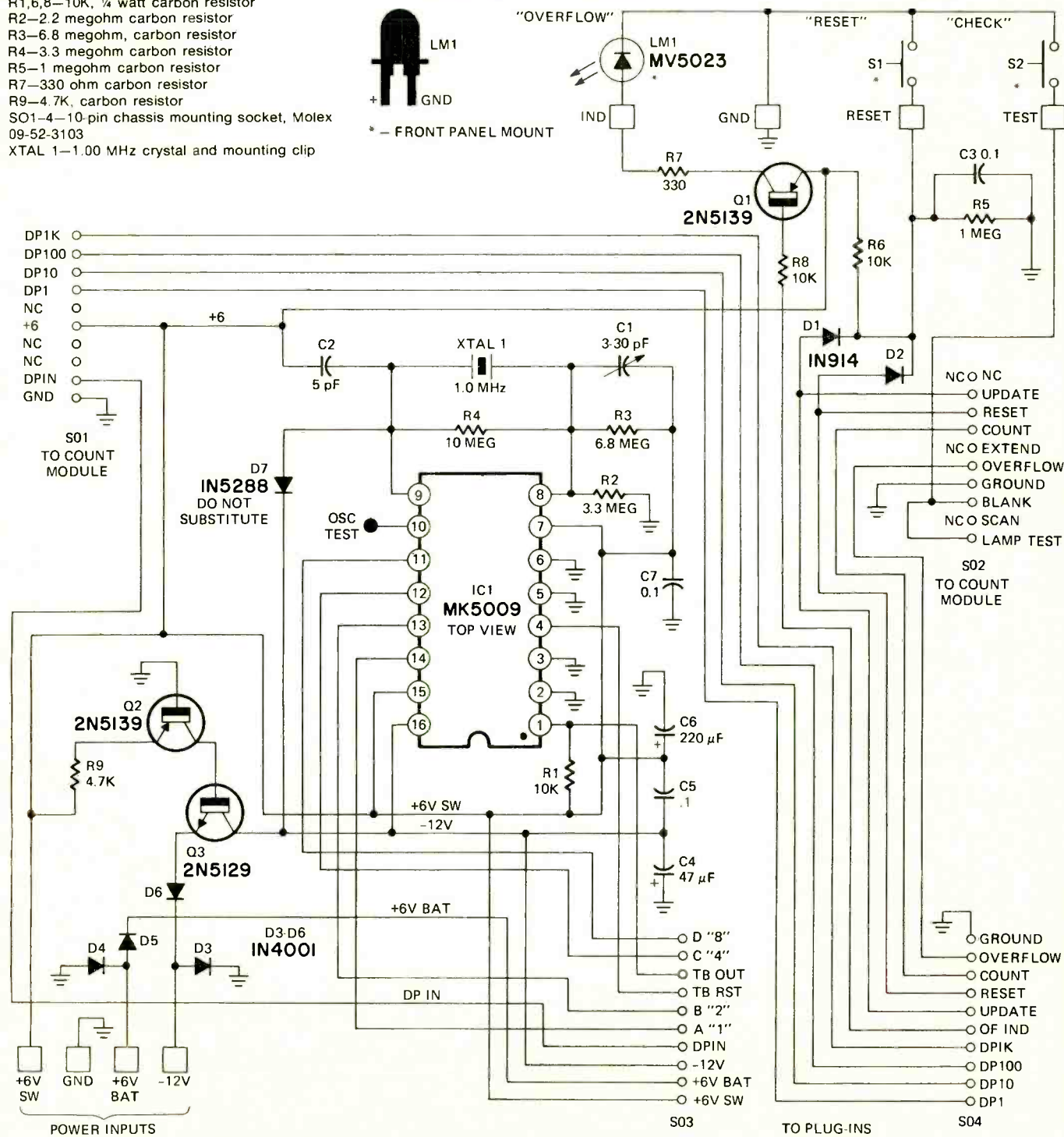

FIG. 2—THE SCHEMATIC shows details of the switching, power control and oscillator circuits.

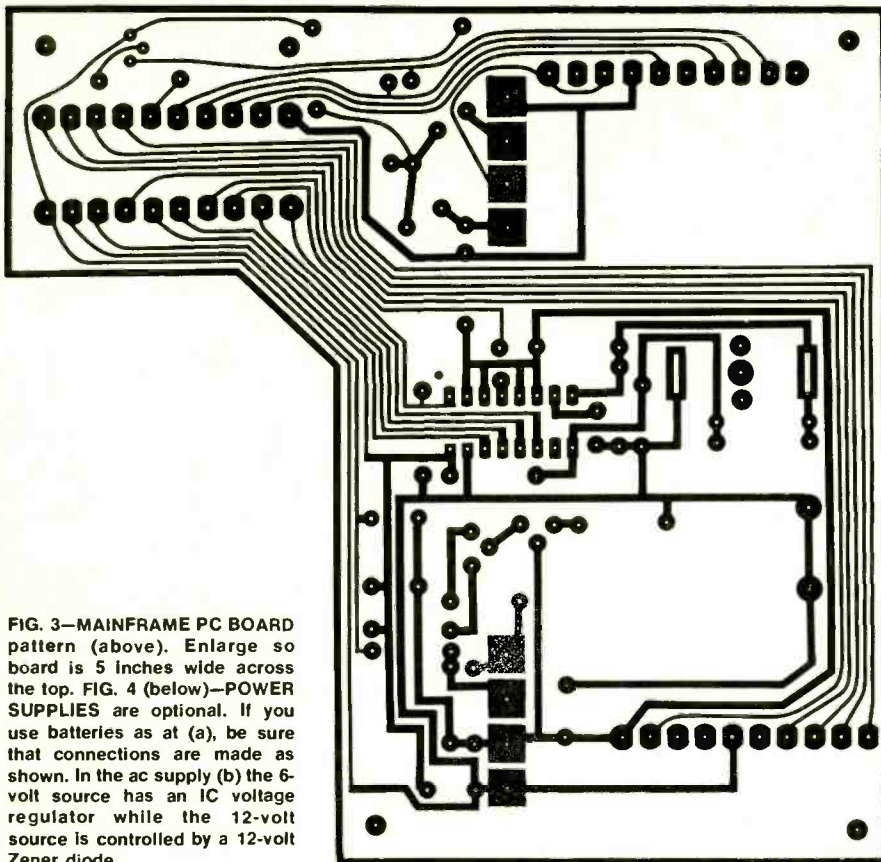
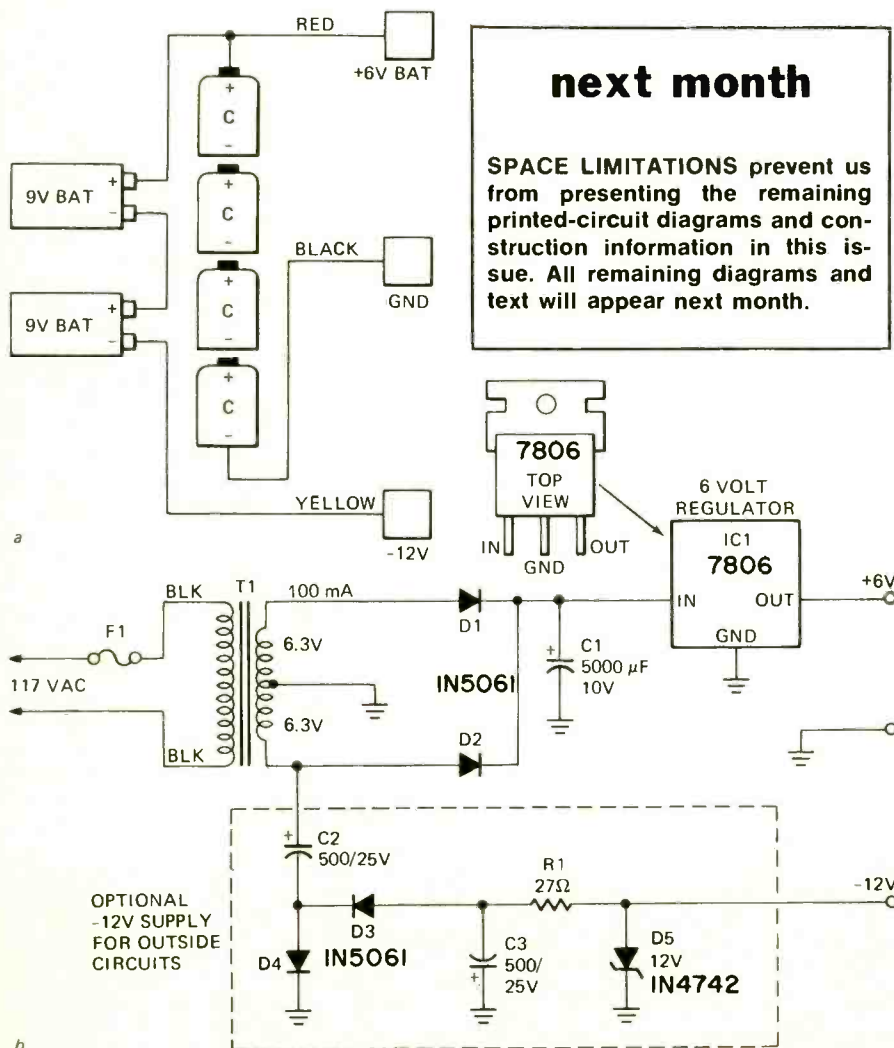

FIG. 3—MAINFRAME PC BOARD pattern (above). Enlarge so board is 5 inches wide across the top. FIG. 4 (below)—POWER SUPPLIES are optional. If you use batteries as at (a), be sure that connections are made as shown. In the ac supply (b) the 6-volt source has an IC voltage regulator while the 12-volt source is controlled by a 12-volt Zener diode.



When you're using the grinchwal with your plug-ins, there are two additional design quirks you have to allow for that could cause you some headaches if you don't know about them. First, note that resetting the counter also resets the internal digit scanner. If you reset the counter too often, some of the numbers will not get displayed, or some of the digits may vary cyclically in brightness. To get around this, limit the number of *new* measurements you make to less than 30 per second. If you must go faster, the scanning capacitor (C1) on the counter plug-in could be reduced in value, but too small a C1 causes decimal-point ghosting and possible leading-edge blanking problems.

The second thing you have to allow for is to make sure that at least one count happens *after* you update if you want to keep the old answer and not reset immediately. This means you can't directly use the falling edge of an input gate as an update if it does away with the input at the same time. The input signal should continue at least one count after updating—making it nearly continuous is one obvious way around the problem.

Ideas for plug-ins

Timebase—Bring out the timing signals and you have a precision scope calibrator, source of timing signals, precision digital clock pulses, a source of timing clocks for lab experiments, an ultra-stable squarewave generator, etc.

Stopwatch—Simply gate the timebase with a set-reset flip-flop to get the time between events, or gate it directly to get the duration of a single event. You can measure any time interval from 10 microseconds to 9999 hours. Use it for a sports timer, a rally computer, photographic stopwatch for shutter testing, physics experiments, ballistic velocity checks, etc . . .

Frequency counter—Use the 0.1-, 1-, or 10-second output of the timebase to turn on and off a signal whose frequency you want to measure. The input frequency should be conditioned by going into a digital comparator. Maximum direct operation is around 200 kHz, but you can easily add scalars to count any frequency you want. With Schottky TTL, you can count beyond 100 Mhz, and by using more than one trip through the counter, you can get more than 4 decades of accuracy. For instance, a 10-second gate and scalars can give you a six-digit accuracy, for any input above 100 kHz.

This list could go on and on. What can you do with a completely portable instrument that will measure or monitor anything you want to 0.01% accuracy? We'll show you how to do some of the common plug-ins. How about you showing us newer and better uses for the Grinchwal? **R-E**

FIG. 1—SKETCH OF VOLKSWAGEN computer system in operation.

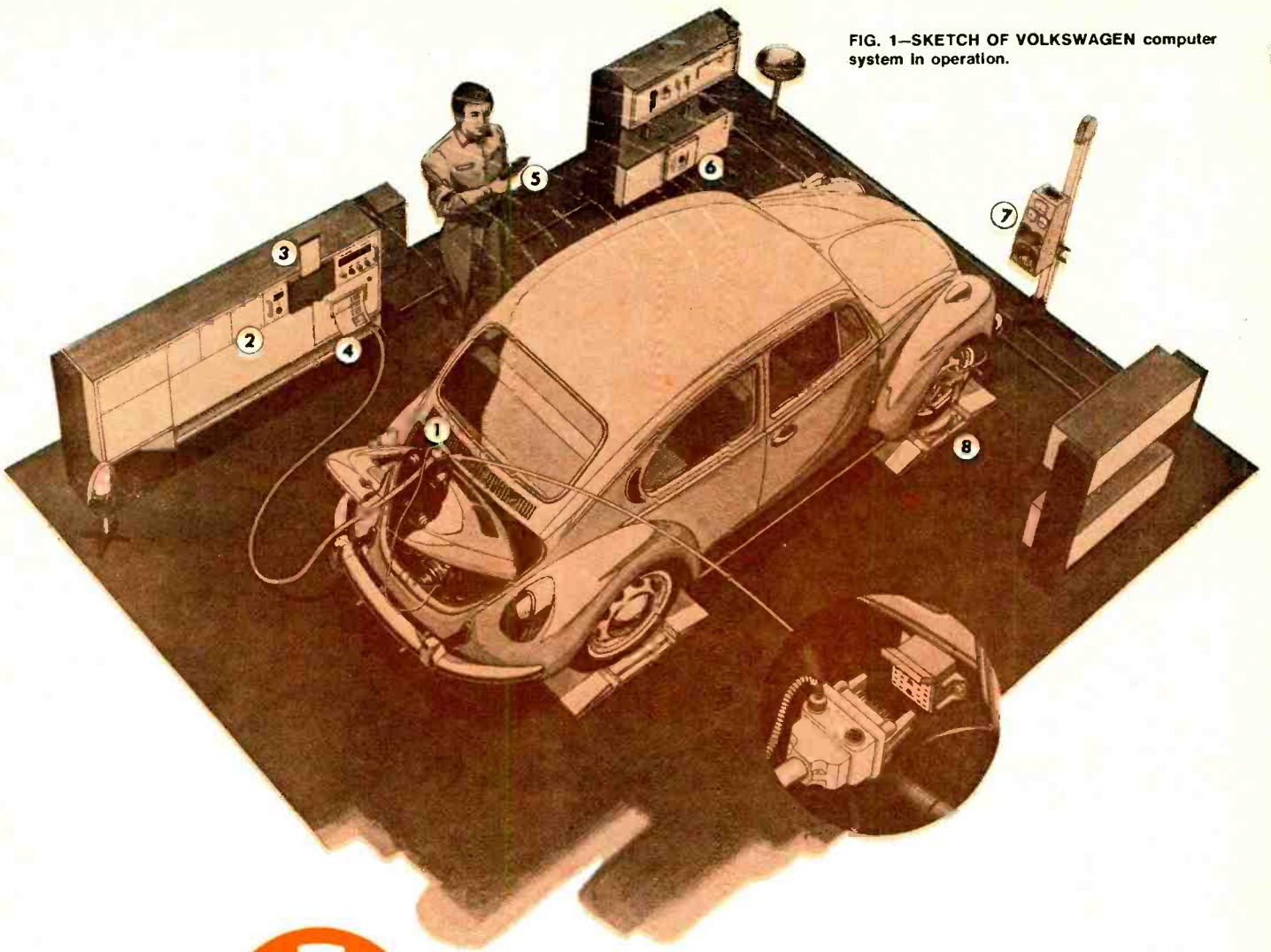

computer checks out your car

A fore-runner of things to come, Volkswagen's built-in self-analysis system slashes auto diagnosis time.

by FRED W. HOLDER

VOLKSWAGEN SCOOPED THE AUTO INDUSTRY IN 1968 WHEN IT introduced electronic fuel injection to avoid the use of power-consuming anti-smog devices. Another "first" is in the offing: computerized self analysis, a system designed to revolutionize automotive diagnosis. Volkswagen is introducing this new system at U.S. dealerships now. The system has been in use at European dealers for some time.

VW's Computerized Self-Analysis System is designed to checkout 1972 and later model Volkswagens, that have a built in central test socket and a network of sensors. It will, however, checkout any 12-volt VW (1965 and later models) through the use of an adapter cable. With a capability for 150 test operations, the system currently makes more than 60 separate checks on the VW Beetle in just 21 minutes. The current diagnosis method takes approximately 42 minutes to complete. The customer receives a printout showing exactly what work needs to be done to bring his car to standard specifications. With this check sheet as a guide, he may save on both parts and shop time.

The system uses space-age telemetry techniques to perform complicated checks of front-wheel alignment, ignition performance, engine compression, and battery condition in

just seconds. The technician connects the system's digital computer to the car's sensor network with a single, multi-strand cable which plugs into the car's central socket. He then inserts a program card into the computer card reader to provide specifications on the year and model of VW being tested. The program card is run through the computer as the technician signals the next test step with a hand-held input unit. The system produces both visual and printed results as the test progresses.

At certain points in the count-down, the system switches to automatic sequence and performs a variety of checks in rapid succession, comparing the readings against standard values and printing the results on a high-speed printer. For example, during one of the four automatic sequences, checks are made and the results printed for: battery voltage, voltage under load; parking, tail, and license plate lights; operation of stop lights; battery acid level; turn signals left; turn signals right; and rear window defogger.

System components

Figure 1 shows the principal components of the system. Item (1), and the insert, shows the central socket and the test

cable used to connect the car to the computer (2). The thin armored cable leading off the top of the plug reads engine oil temperature. The computer console contains the program card reader (3). Each VW from Beetle to Bus has its own program card. Results of the more than 60 checks performed on the vehicle are recorded by the high-speed printer (4).

Many of the tests are performed by the technician using a hand-held input unit (5). The technician is told the "count down" sequence by a visual display in the hand-held unit. Buttons are provided to indicate GO and NO-GO conditions for visual checks.

Front wheel alignment is inspected using a photo-electric unit (6). The condition of the alignment is tested and recorded simply by turning the steering wheel. At a given position, camber and toe-in are recorded for each front wheel. Headlights are checked for both brightness and adjustment by the tester (7) mounted on tracks at the front of the car. Proper setting of the car for front wheel and headlight checks is ensured by positioning it on four pads (8). These pads also place the car correctly over a hoist that lifts the car for under-vehicle inspections.

Functional description

As shown on the block diagram of Fig. 2, test signals from the car's sensor network are routed through a 28-strand cable to the signal conditioning circuits. Here, the signals are conditioned, amplified, filtered, and brought into a system-



TECHNICIAN USES HAND-HELD INPUT UNIT to follow test countdown. Unit feeds the test findings into the computer at left.

compatible form. They are then available for multiplexing and further processing.

Analog storage holds peak and temporary data until it is called for by the multiplexer. The multiplexer uses field-effect transistors and reed relays to select the desired test data channels, as instructed by the test step on the program card, and routes it to the analog-to-digital converter (ADC). The ADC converts the analog voltage signal to its equivalent as a three digit binary coded decimal (BCD) number for display and printing. The ADC is a voltage-to-frequency converter with a conversion rate of 100 Hz per volt.

With an input voltage of 10 volts, the total error is less than 0.5%. The output frequency is gated with a time-base signal and used to drive a three-digit BCD counter. The output of the counter is decoded and displayed. Also, the BCD data value is simultaneously checked in the dynamic comparator to determine whether it is within the tolerance limits specified by the program card.

Figure 3 shows the working principle for one BCD digit of the comparator. The lower tolerance range limit digit is

gated with the BCD digit at gate group G1. At the start of the conversion time (when the time base signal enables the gate and allows the ADC signal to drive the BCD counter), the counter data content is zero and the flip-flop FF1 is in the NO-GO state. As the count increases and reaches the lower limit, a coincidence signal is generated by gate G2 and flip-flop FF1 is set to the GO state. If the BCD counter value exceeds the upper limit at gate group G3 before the time base signal stops the count, flip-flop FF1 is reset to the NO-GO state. The results

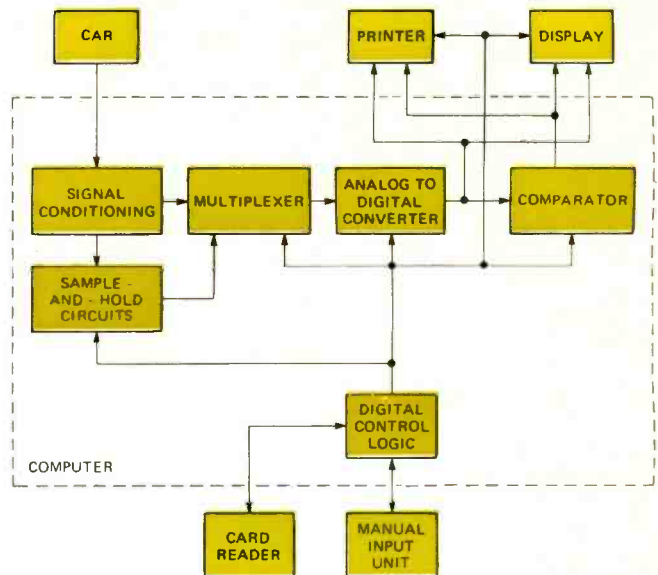

FIG. 2—BLOCK DIAGRAM of computerized self-analysis system shows the major functional areas and their interconnections.

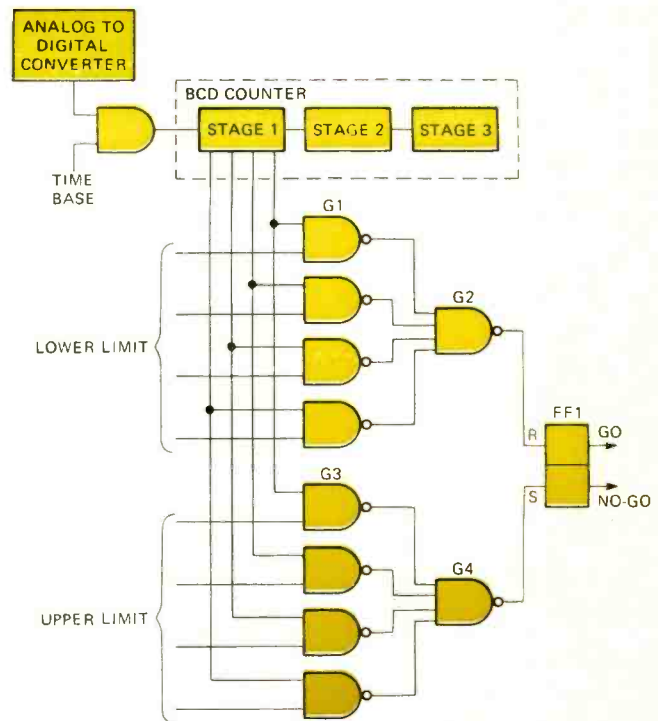

FIG. 3—SIMPLIFIED DIAGRAM OF COMPUTER CIRCUIT used to check test values from the automobile against specified limits.

of the comparator check are displayed on the computer console and printed as a plus or minus sign next to the actual data value. The printer is a version of the standard type used in small calculators. It has been adapted to meet the special application of this system.

Testing progresses automatically until a visual or manual test must be made. (Such tests include operation of the windshield wiper, windshield washer, condition of tire tread, oil

leaks, etc.) At this point, a film strip in the hand-held manual input unit tells the technician what to check. If the item checks OK, he presses the plus-sign button; if it doesn't, he presses the minus-sign button. Either button advances the sequence to the next item to be checked. The technician continues to perform tests until another automatic sequence is reached. The film then advances automatically in synchronization with the test program as checks are completed until another manual check is indicated on the program card. This procedure continues until all of the more than 60 tests are completed.

All of these activities are supervised by the central control unit, which receives inputs from the program card, the manual input unit, and the car itself. It generates the control signals necessary to perform each test step and record the resulting data.

The program card has a capacity of 150 test steps although only about 60 are used at present. The card contains a 32-bit control word for each test step as shown in Fig. 4. Bits 1 through 6 designate the test subprogram to be used and bits 7 through 14 designate the multiplexer data channel to be sampled. Bits 15 through 22 contain the lower acceptable limit

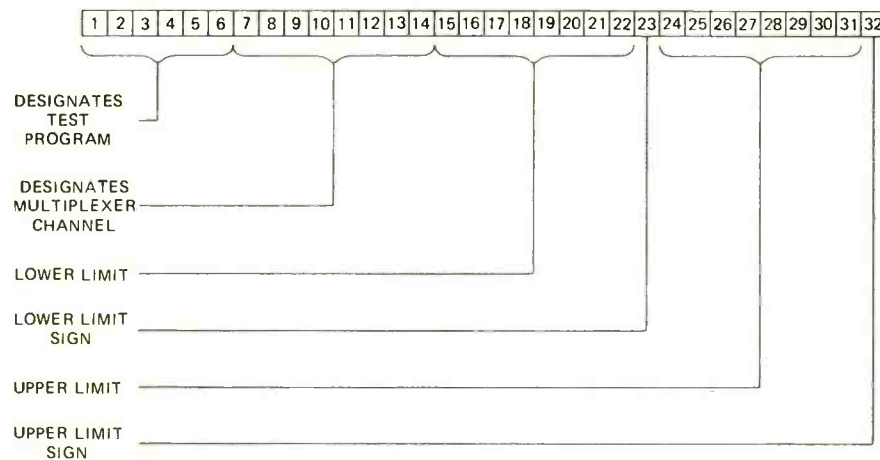

FIG. 4—MAKE-UP OF THE PROGRAM-CARD CONTROL WORD. A separate 32-bit control word is used for each of 60 different tests.

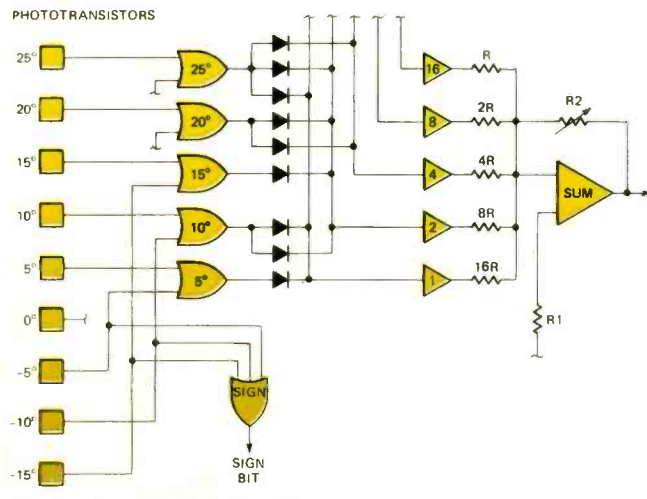

FIG. 5—SIMPLIFIED DIAGRAM OF DECODING CIRCUIT USED TO CONVERT phototransistor signals into a scaled analog voltage.

and bit 23 the sign for the lower limit. Bits 24 through 32 contain the upper limit value and its sign.

Automatic tests

During automatic tests, the system monitors and records the status of the item being checked. These tests include items such as turn signals, parking, tail, and license plate lights, stop lights, defogger, battery, wheel alignment, starter perform-

mance, compression, dwell angle, generator and regulator, and headlights. All of these items except wheel alignment are checked by monitoring the internal test circuits wired to the central socket on the vehicle.

Current Consumer Tests: Includes items such as light bulbs and the defogger heating coils. Because the power consumption at a given voltage depends upon the resistance of the circuits, it is possible to learn a great deal from a resistance check. This is especially true when there are a limited number of consumers in a circuit; for example, the stop light circuit. In this case, if either of the two lamp filaments are shorted or open, a significant and measurable change from the standard reading will occur. Thus, the turn signal; parking, tail, and license plate lights; stop lights; and rear window defogger circuits are all checked by passing a current through the circuit, measuring the voltage drop, and comparing it against the limits specified on the program card.

Battery Checks: Three checks are made on the storage battery: (1) First, the battery voltage is read and recorded without any load. (2) Then, a resistor is switched into the circuit to provide a temporary test load for a specified length of time. Just before the load-time runs out, the battery voltage is

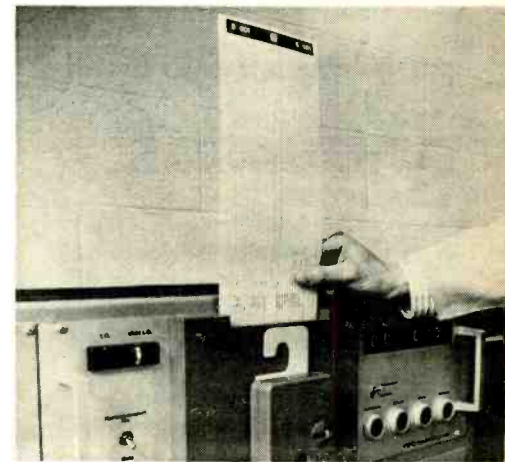

PROGRAM CARD is fed into card reader to ready the system to check out the next car.

recorded and compared to the tolerance limits specified for this test. (3) Finally, a built-in probe, normally immersed in the battery electrolyte, provides an electric potential reading to the computer. If the electrolyte drops to an unsafe level, the probe is no longer in contact with the electrolyte. The electric potential is missing from the probe, indicating a NO-GO condition to the computer.

Front-End Alignment: The front-end alignment is measured automatically by optical/electronic equipment using mirrors attached to the front wheels. A cross-configured light beam is directed from a projector to the mirror attached to the wheel. The mirror reflects the cross of light to the projector backing plate where it illuminates two rows of phototransistors, one row for vertical and one row for horizontal. The camber and toe data are indicated by the shift of the projected cross in relationship to the location of the zero coordinates of these rows. By turning the steering wheel, the technician triggers the sensors and obtains a measurement having an accuracy of five minutes of arc. The signals from the phototransistors are decoded and fed into the computer for evaluation.

Figure 5 is a simplified diagram of the decoding scheme used to convert the phototransistor signals into scaled data for processing and printing. The circuit features an adjustment (R2) to compensate for different width workstalls in the various dealerships. Also, because the reflected light beam covers two adjacent phototransistors, it is necessary to use a one-step code to prevent inaccurate readings. The extended Gray code was selected for this system. The characteristics of this code is

that a change of the code word by one step causes a change of only one bit. (Figure 6 shows sample bit configurations for this code.)

The same data value will be recorded whether the plus or minus phototransistor has been illuminated by the cross of light, because the outputs of phototransistors having like val-

STEPS	WEIGHT				
	1	2	4	8	16
1	1	0	0	0	0
2	1	1	0	0	0
3	0	1	0	0	0
4	0	1	1	0	0
5	1	1	1	0	0
6	1	0	1	0	0
7	0	0	1	0	0
8	0	0	1	1	0

FIG. 6—GRAY CODE is a cyclic code used to minimize errors when converting analog quantities into binary form. This is a sample.

ues are OR-gated before encoding into the Gray code. The output of all negative phototransistors are OR-gated to produce the sign bit.

The encoded signals are then converted to weightable binary code in a summing network. The resulting analog voltage is scaled to compensate for work stall width. The analog voltage output of the summing amplifier changes synchronously with the steering wheel motions made by the technician. As the steering wheel is rotated, this analog voltage is sampled and stored until called by the computer for processing.

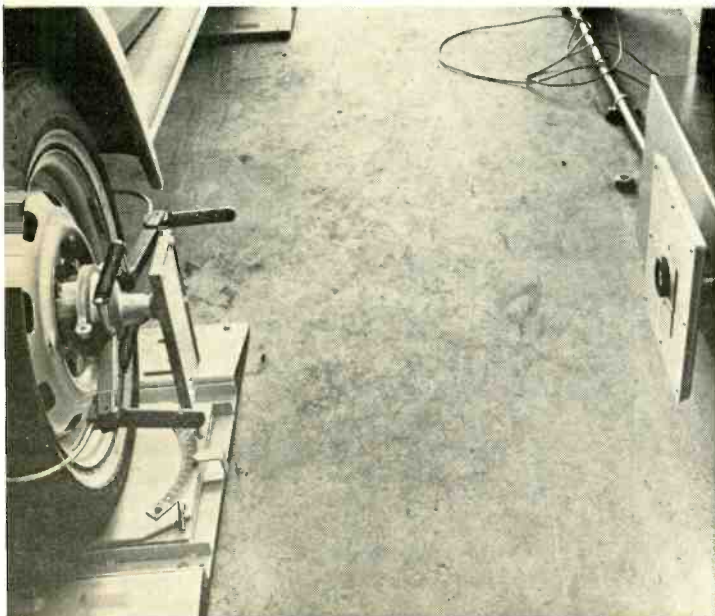

LIGHT FROM PROJECTOR (right) is directed to mirror attached to front wheel to check the vehicle's front-end alignment.

Starter and Compression Test: When the starter motor is activated, an analog voltage drop is developed in the battery ground strap near the car body. This voltage drop is in the order of millivolts and must be amplified before it is processed; however, it contains the necessary data to evaluate starter motor performance and cylinder compression. This analog voltage contains two components: a dc-component de-

veloping the power required to overcome the mechanical drag inherent in the entire starting system and a superimposed ac-component which depicts the variation in starter motor current caused by cylinder compression.

The ignition circuit is grounded through a resistor during this test to prevent the engine from starting. The starting procedure is long enough to allow good engine rotation before the starter current test is triggered. At this time, the starter current is read and four positive peaks of the ac-component are read and stored for evaluation. These peaks are related to their respective cylinders by correlating them with the trigger impulse sensor on the cylinder number one ignition cable. The lower limit of the peak values is automatically checked and compared with the nominal values given on the program card.

Dwell Angle Check: The dwell angle check is a measure of the equivalent time during which the breaker points are



COMPUTER PRINT-OUT tells mechanic and VW owner what needs to be done to bring the automobile up to standard specifications.

closed. During this test, the ignition coil terminal is monitored and the resulting voltage surge caused by the ignition points opening and closing is converted to a rectangular impulse. These rectangular impulses are integrated into a dc voltage level, which is an analog voltage representing dwell angle.

Regulator and Generator Check: At 2000 rpm the generator voltage is reached and the voltage ripple resulting from the regulating process is smoothed out. Thus, when the engine rpm reaches 2000, the voltage is sampled. An external resistor is then switched into the generator output circuit to check it under load. After a defined period, the voltage is sampled, stored, displayed, and printed.

The Computerized Self-Analysis System marks a new trend in automotive servicing. It aids the mechanic in diagnosing complex systems and prevents him from inadvertently skipping items that should be checked. The result should be a savings in time and money for the VW owner, as well as greater confidence that his car is performing to standard specifications.

R-E

VECTORSCOPIES

This oft-ignored test instrument has no peer in some phases of color TV servicing. Get to know and use it.

How to use them

by ROBERT G. MIDDLETON

ALTHOUGH VECTORSCOPIES HAVE BEEN around for some time, few of us know how they work, and how to use them in TV troubleshooting procedures. Therefore, let's start at the beginning and take it step by step.

There are several types of vectorscopes, and as would be anticipated, we can do more with the comparatively elaborate instruments. Fig. 1 shows the configuration of a basic vectorscope. It is simply a cathode-ray tube with supply voltages, operating controls, and capacitive coupling to the vertical and horizontal deflection plates. This arrangement has a deflection sensitivity of roughly 35 volts peak-to-peak per inch, depending on the screen size and type of crt.

Basic Lissajous patterns

All vectorgrams are based on Lissajous patterns. If we apply sinewave voltages of the same amplitude and frequency, but with a phase difference of 90° to the vertical and horizontal deflection plates respectively, we expect to obtain a circular pattern, as in Fig. 2. However, in practice, the sinewave voltage applied to the horizontal deflection plates (Fig. 1) must have somewhat greater amplitude to form a circular pattern, because the deflection plates nearest the screen have less sensitivity than the plates farthest from the screen. Aside from practical details, a circular Lissajous pattern corresponds to sinewave vertical and horizontal deflection voltages that have the same frequency, nominally the same amplitude, and a phase difference of 90° .

Most vectorgrams have an elliptical outline. Typical elliptical Lissajous patterns and their corresponding phase angles are shown in Fig. 3. We observe that if the vertical and horizontal deflection voltages have the same amplitude, any ellipse that is formed will lean 45° with respect to the vertical and horizontal axes. Next, let us consider the patterns that are obtained when the vertical deflection voltage is greater or less than the horizontal deflection voltage. These patterns are easily demonstrated

with a slightly more elaborate vectorscope; one that has vertical and horizontal amplifiers, in addition to the basic arrangement shown in Fig. 1. These amplifiers are identical, and have a bandwidth of 1 MHz.

If we start with a circular pattern, and then advance the vertical gain of the vectorscope, we get an ellipse (Fig. 4-a). On the other hand, if we start with a circular pattern, and then advance the horizontal gain, we get the elliptical pattern shown in Fig. 4-b. Note that these ellipses are either vertical or horizontal—they do not lean with respect to the screen axes. Next, if we start with an ellipse such as the 120° ellipse in Fig. 3, and then advance the vertical gain of the vectorscope, the ellipse will have a greater height and will lean less than 45° with respect to the vertical axis. On the other hand, if we start with the 120° ellipse as before, but advance the horizontal gain, the ellipse will be displayed at less height, and will lean more than 45° with respect to the vertical axis.

There are two ways to determine

the phase angle corresponding to an elliptical Lissajous pattern. A quick method consists of adjusting the vertical screen deflection to equal the horizontal screen deflection. As in Fig. 3, the vertical and horizontal tangents to the ellipse will then form a square. In turn, the indicated phase angle can be approximated by comparison with the examples given in the diagram. Although this is not a highly accurate method, it is generally adequate for troubleshooting chroma circuitry.

Sometimes we work with the basic vectorscope arrangement shown in Fig. 1. In this case, the vertical and horizontal screen deflections cannot be readily equalized. Therefore, the method of phase-angle determination in Fig. 5 is used. We center the pattern on the screen, and measure the distances a and b . In turn, the ratio a/b gives the sine of the phase angle, and the angle can be found from a table of sines. This is a general and comparatively accurate method. Note that the ratio a/b in Fig. 5 remains unchanged regardless of the

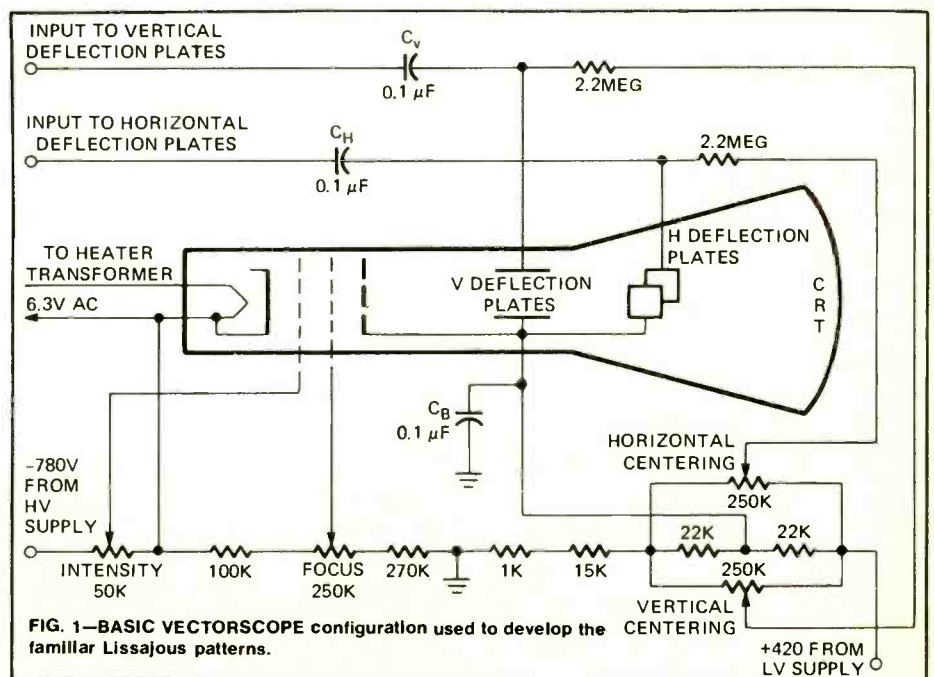

FIG. 1—BASIC VECTORSCOPE configuration used to develop the familiar Lissajous patterns.

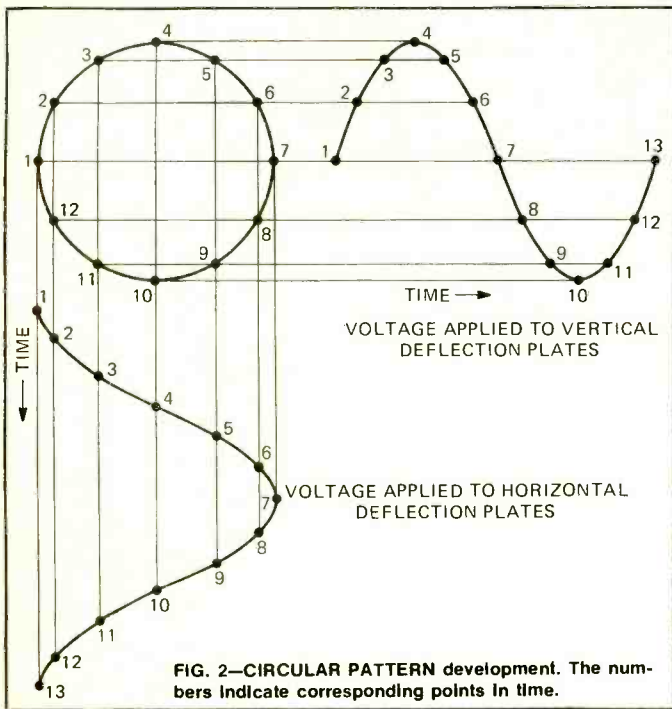

FIG. 2—CIRCULAR PATTERN development. The numbers indicate corresponding points in time.

FIG. 5 (at right)—MEASUREMENT of phase angle of deflection voltages indicated by an ellipse. The sine of a/b equals the sine of the phase angle.

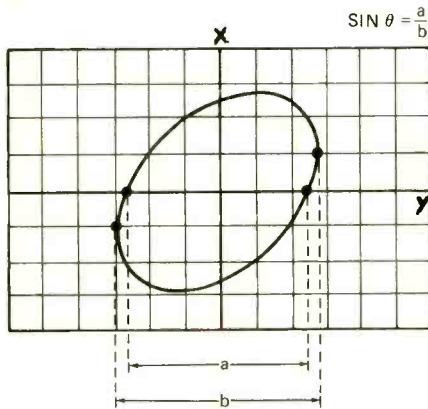
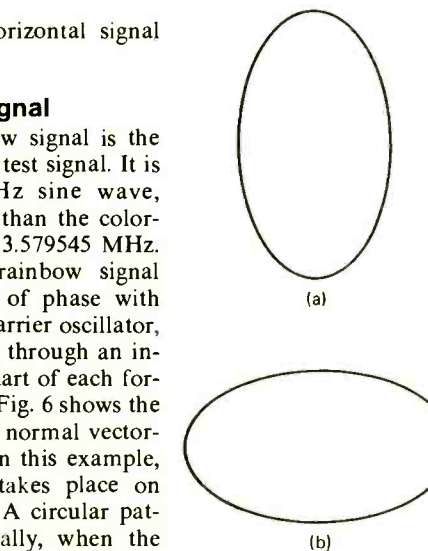

FIG. 4 (below)—PATTERNS formed by unequal deflection voltages with 90° or 270° phase difference. Vertical voltage greater at a, horizontal voltage greater at b.



ratio of vertical and horizontal signal amplitudes.

Unkeyed rainbow signal

An unkeyed rainbow signal is the simplest type of chroma test signal. It is simply a 3.563795-MHz sine wave, which is 15,750 Hz less than the color-subcarrier frequency of 3.579545 MHz. In turn, an unkeyed rainbow signal shifts progressively out of phase with the receiver's color-subcarrier oscillator, and the two signals pass through an in-phase condition at the start of each forward-scanning interval. Fig. 6 shows the basic test setup, and the normal vectorgram that is obtained. In this example, chroma demodulation takes place on the R-Y and B-Y axes. A circular pattern is displayed normally, when the vertical and horizontal signal amplitudes are equalized. Note that the "pie cut" is produced by horizontal blanking action in the receiver.

It is helpful to note some typical trouble indications that may be observed. For example, a leaky capacitor in the subcarrier phase-shifting network causes demodulation angle to shift from

its correct value of 90° . That is, if the hue control is adjusted to provide demodulation on the R-Y axis, then demodulation cannot occur on the B-Y axis, and vice versa. Approximately half of the hues are more or less distorted in the reproduced color picture. In this situation, a vectorgram such as depicted in

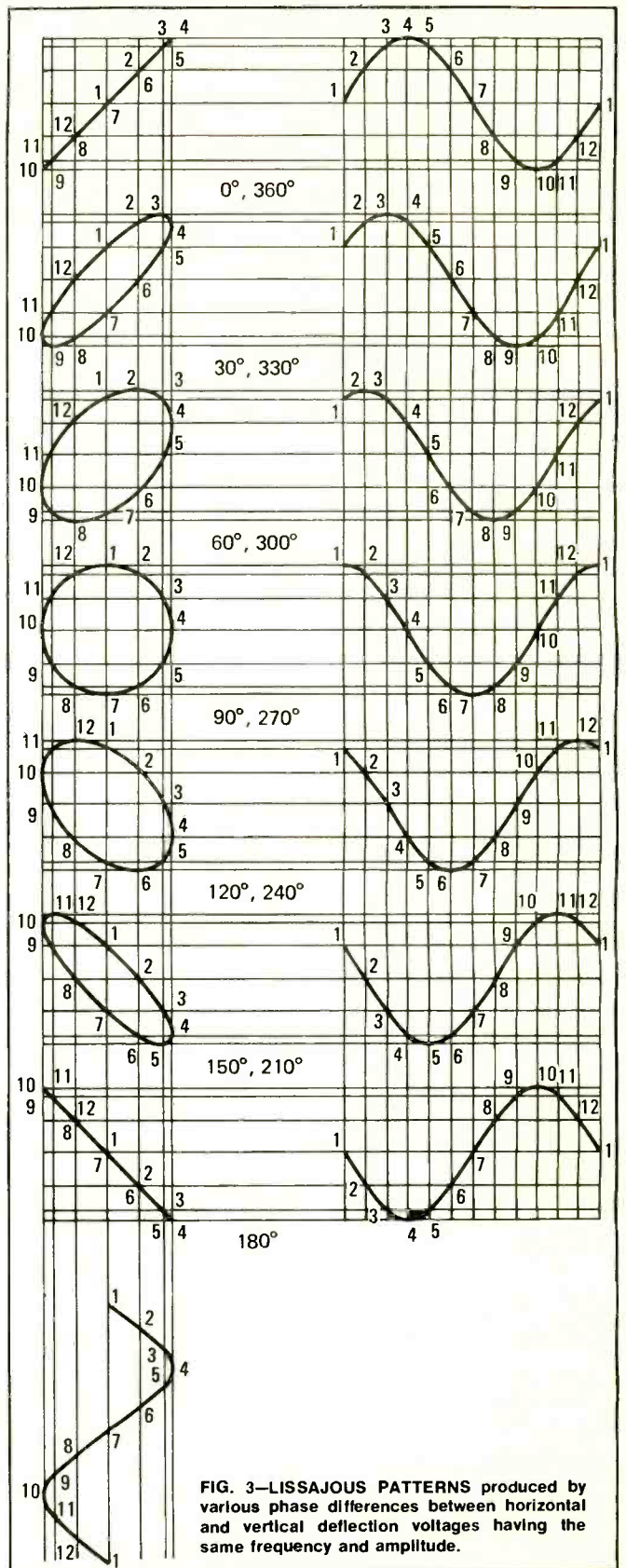

FIG. 3—LISSAJOUS PATTERNS produced by various phase differences between horizontal and vertical deflection voltages having the same frequency and amplitude.

Fig. 7 pinpoints the trouble. That is, an inclined ellipse is displayed, instead of a circular vectorgram.

Various forms of nonlinear distortion can occur, due to defects in chroma circuitry. For example, off-value resistors or leaky capacitors can cause incorrect bias voltages, with re-

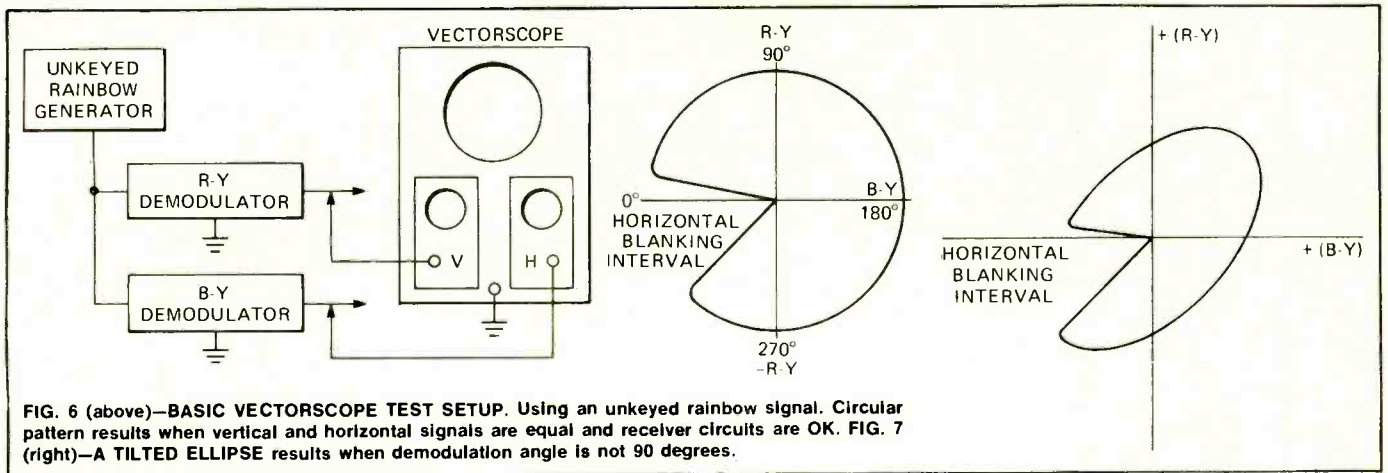

FIG. 6 (above)—BASIC VECTORSCOPE TEST SETUP. Using an unkeyed rainbow signal. Circular pattern results when vertical and horizontal signals are equal and receiver circuits are OK. FIG. 7 (right)—A TILTED ELLIPSE results when demodulation angle is not 90 degrees.

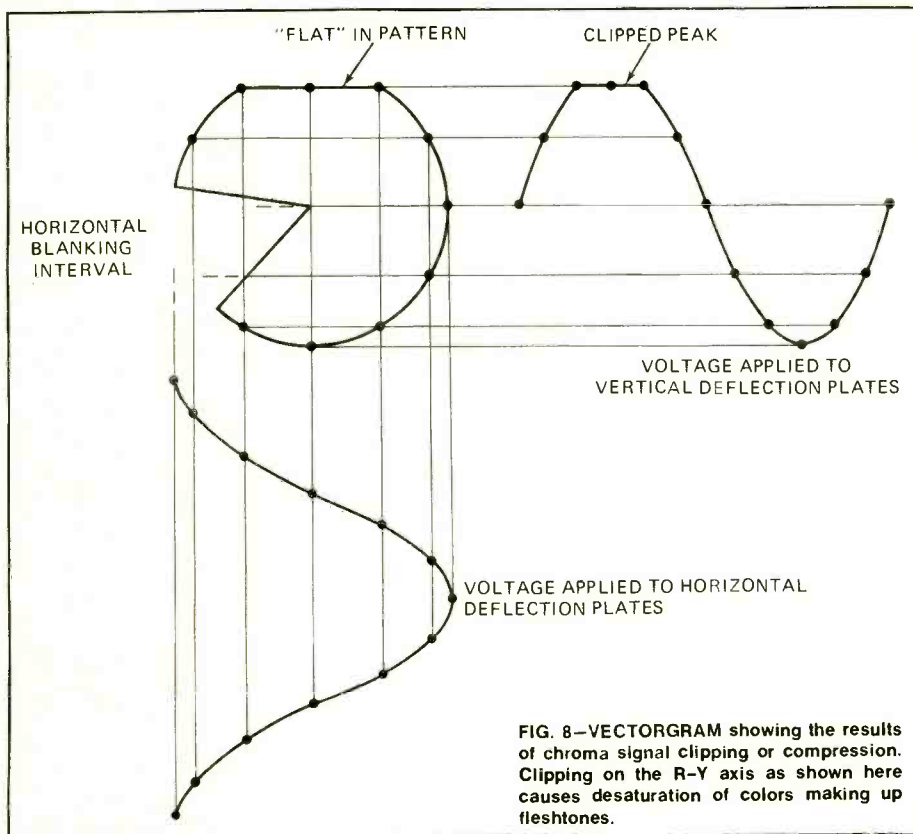

FIG. 8—VECTORGRAM showing the results of chroma signal clipping or compression. Clipping on the R-Y axis as shown here causes desaturation of colors making up flesh tones.

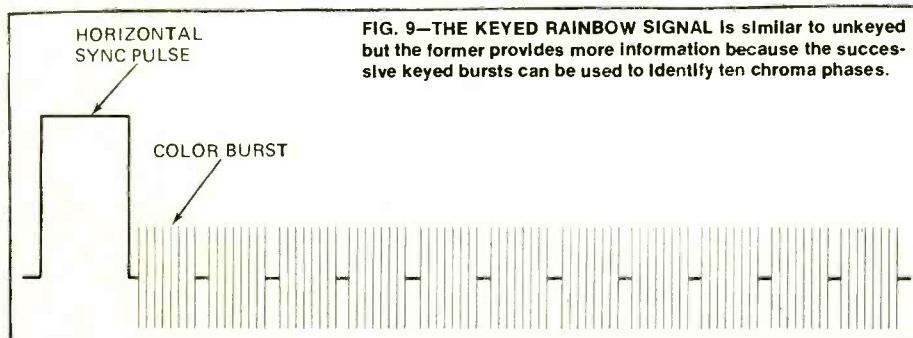

FIG. 9—THE KEYED RAINBOW SIGNAL is similar to unkeyed but the former provides more information because the successive keyed bursts can be used to identify ten chroma phases.

sulting compression or clipping of the chroma signal. Fig. 8 shows a vectorgram that results from positive-peak clipping of the R-Y signal. This type of distortion produces weakened or desaturated reproduction of the corresponding hues. In this example, the flesh tones would be affected. The dis-

torted vectorgram identifies the fault, and helps to locate the defective component.

Keyed rainbow signal

A keyed-rainbow signal, as depicted in Fig. 9, has the same basic characteristic as an unkeyed rainbow

signal. In addition, the keyed signal provides more information, because the successive bursts identify 10 chroma phases. It is helpful to start with consideration of the same test setup as depicted in Fig. 6, but employing a keyed-rainbow generator. In such case, the ideal vectorgram that results is developed as shown in Fig. 10. Note that the tops of the R-Y and B-Y bar signals fall along a 15,750-Hz sine wave in the ideal case, and the tops of the vectorgram petals fall along the circumference of a circle.

In actual practice, the tops of the R-Y and B-Y bar signals do not have sharp corners, but are rounded as depicted in Fig. 11. This corner rounding results in rounding of the tops in the vectorgram petals. As in square-wave or pulse test work, corner rounding of chroma-bar waveforms results from limited high-frequency response. The R-Y and B-Y bar signals in Fig. 11 are idealized in that the pulse waveforms have zero rise time. In practice, of course, the rise time is slowed down to an extent that is determined by the bandwidth of the chroma circuits. It is instructive to consider the situation in which the bar signals have half-sine waveforms. As shown in Fig. 12, the vectorgram petals are formed of single straight lines in the ideal situation.

This ideal situation may be partially realized in practice, as illustrated in Fig. 13. Note that three of the vectorgram petals approximate straight lines, although the remaining petals have appreciable widths. There are some other practical points to be observed in Fig. 13. First, only nine petals appear in the vectorgram, while the ideal pattern in Fig. 10-b has 10 petals. The "lost petal" is due to a comparatively long horizontal blanking interval (slow horizontal flyback). Observe also that the horizontal blanking interval appears in the upper right-hand part of the vectorgram in Fig. 13. This is due to the fact that the cathodes of the color picture tube are driven by the chroma signal in this example.

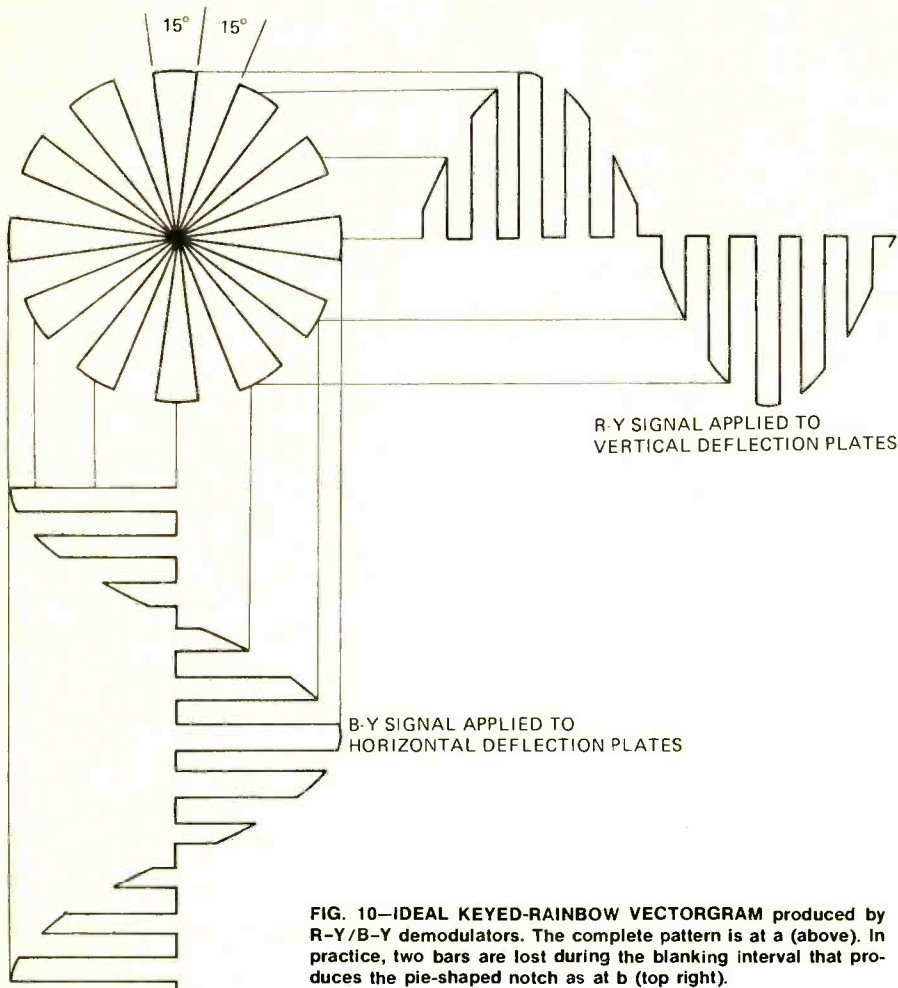

FIG. 10—IDEAL KEYED-RAINBOW VECTORGRAM produced by R-Y/B-Y demodulators. The complete pattern is at a (above). In practice, two bars are lost during the blanking interval that produces the pie-shaped notch as at b (top right).

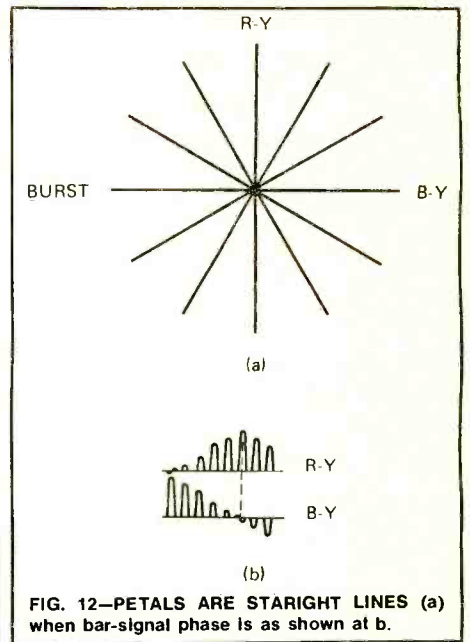
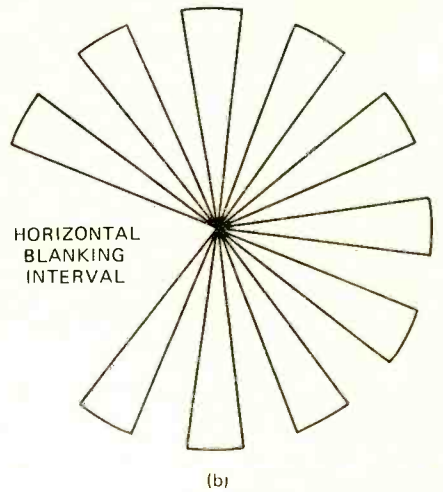

FIG. 12—PETALS ARE STRAIGHT LINES (a) when bar-signal phase is as shown at b.

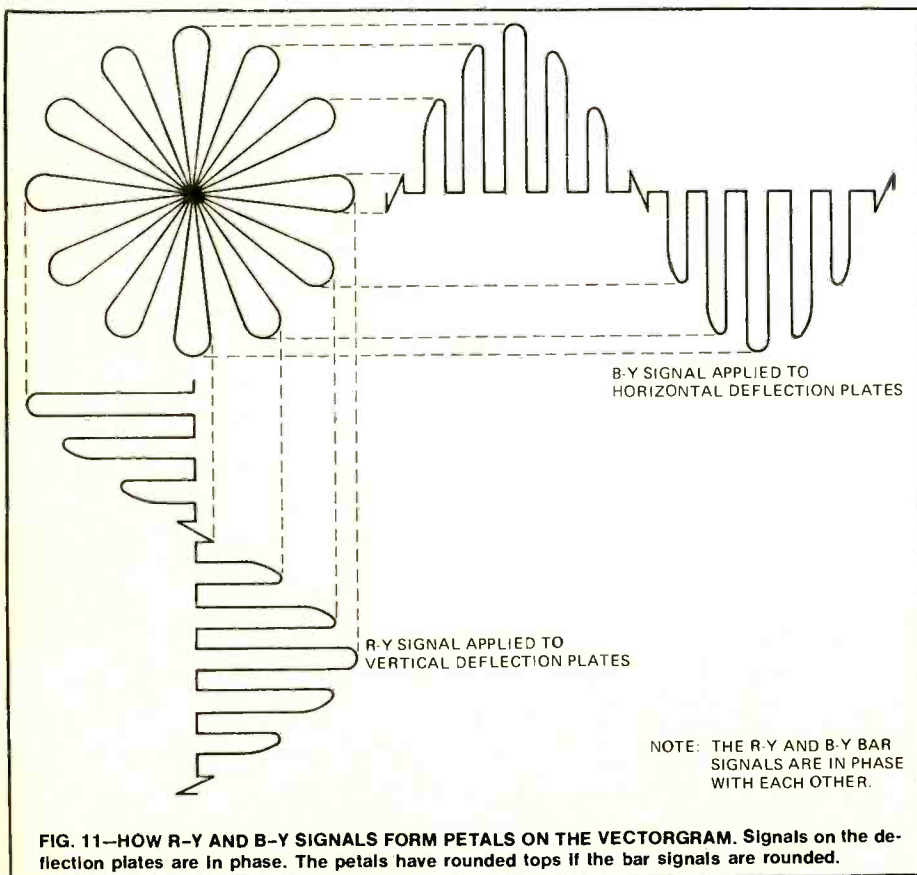
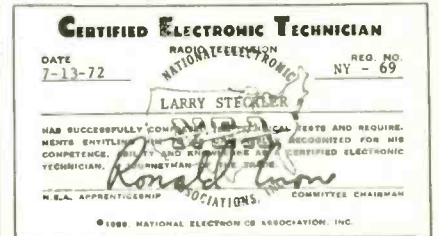

FIG. 11—HOW R-Y AND B-Y SIGNALS FORM PETALS ON THE VECTORGRAM. Signals on the deflection plates are in phase. The petals have rounded tops if the bar signals are rounded.

Next, let us consider the case in which one bar signal leads or lags the corresponding bar signal slightly. For example, we will suppose that the B-Y waveform is moved slightly to the right in Fig. 12-b, so that the peaks of the R-Y and B-Y pulses no longer occur at exactly the same instant. The result of this shift is the formation of elliptical petals in the corresponding vectorgram, as depicted in Fig. 14. Again, let us suppose that the R-Y and B-Y pulses are in exact time coincidence, but that the R-Y pulses are slightly wider than the B-Y pulses. The result is to change the straight-line petals in Fig. 12 into widened petals, somewhat similar to those seen in Fig. 13.

Another fact that we observe in Fig. 13 is that the petals extend down to the center of the vectorgram, where they form a bright spot. This means that the chroma circuits have adequate bandwidth. On the other hand, if the chroma coupling circuits have insufficient bandwidth, the center of the resulting vectorgram is an "open circle".

R-E editors now CET's



Editor Larry Steckler is now the proud holder of his CET certificate, N.Y. #69. His comments on the CET test—"It was more difficult than I expected it to be. I'd like to see every technician take the test and earn his certificate."

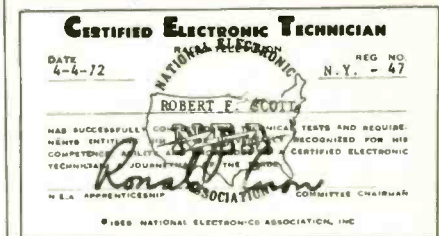

Technical Editor Robert F. Scott and his CET certificate, N.Y. #47. Bob and Larry both conduct CET tests in the metropolitan New York area regularly.

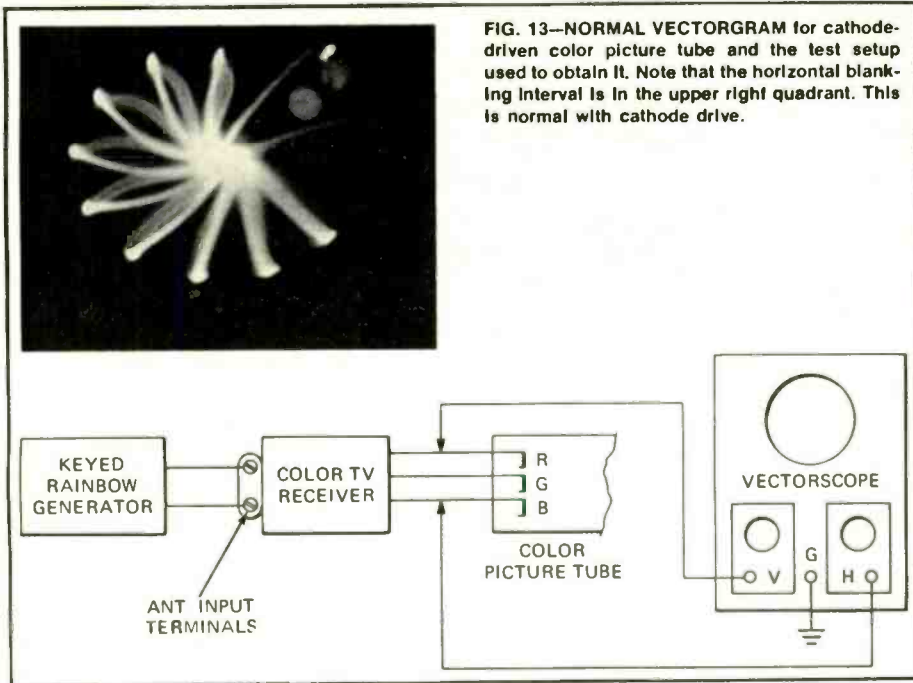

FIG. 13—NORMAL VECTORGRAM for cathode-driven color picture tube and the test setup used to obtain it. Note that the horizontal blanking interval is in the upper right quadrant. This is normal with cathode drive.

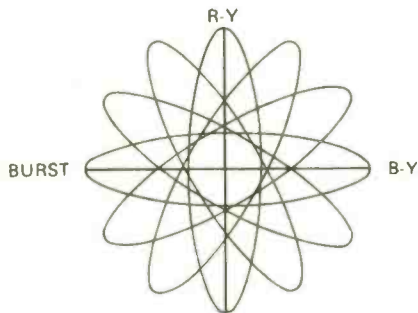

FIG. 14—PETALS ARE FORMED BY ELLIPSES when the R-Y or B-Y bars are delayed.

This results from baseline curvature introduced into the R-Y and B-Y waveforms. In case the R-Y and B-Y channels have insufficient and unequal bandwidths, the center of the vectorgram is an "open ellipse".

Finally, let us consider the chief distortions that appear in the vectorgram in Fig. 15. Nonlinear distortion is immediately apparent. For example, the +Q petal is considerably longer than the +I petal. Overload distortion is evident in the tops of the -I, -(R-Y), and +(G-Y) petals, in particular. By way of comparison, the +(B-Y) petal shows little or no overload distortion. Nonlinear distortion is usually caused by incorrect grid or base bias. Leaky coupling capacitors are the most likely culprits. To close in on the defective stage, vectorgram patterns can be checked back step-by-step from the picture tube to the chroma demodulators.

Vectorgrams are very informative in chroma troubleshooting procedures, provided that we know how to interpret the patterns. There is more information in a vectorgram than in a conventional waveform, because a vectorgram is produced by sweeping one signal against

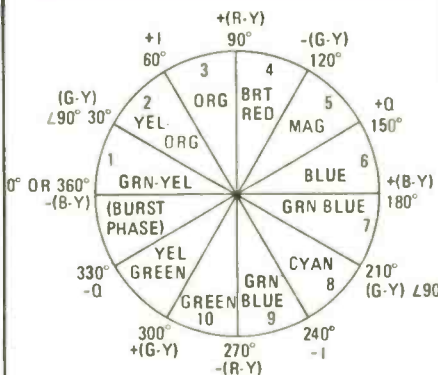
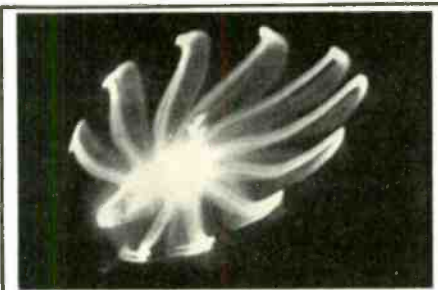

FIG. 15—NONLINEAR DISTORTION is evident in the vectorgram at top. This is indicated by the fact that some bars are much longer than others. Overloading is indicated by the squaring-off of the tops of some of the petals—particularly those developing between 240 and 300 degrees. The drawing illustrates chroma hue and phase reference.

another. The most useful type of vectorscope provides vertical and horizontal amplifiers so that tests can be made in low-level chroma circuits. Although only the most basic points can be covered in the available space, the foregoing discussion should get the apprentice technician off to a good start. As he gains experience in troubleshooting with the vectorscope, many other test techniques and pattern interpretations will unfold.

R-E



NTS Home-Training in Electronics was the start of something big for James Gupton

An NTS Graduate

James A. Gupton Jr. graduated from National Technical Schools with a diploma in TV & Radio Servicing. Today, he's a mighty important man in the world of Electronics!

Research associate with a major electronics corporation; author of numerous articles in electronics magazines; an inventor with five patent applications to his credit. In the field of electro-optics, he has perfected a revolutionary phosphor deposition technique for cathode ray tubes.

Quite a list of accomplish-

ments for a man who began his career with an NTS diploma and a job in TV & Radio servicing.

Any student can succeed

James Gupton is certainly an exceptional NTS graduate. He proves there's nothing to keep a determined man from becoming a success in Electronics. As he himself says, "Any student, properly motivated, can succeed in Electronics through home-training."

Every NTS Electronics Course is specially designed to keep you motivated from the time you

start building your first test instrument until you're ready to plug-in your solid-state Color TV or other advanced electronics equipment.

Exciting "Project Method" Training

NTS Project Method Training is the best way to learn electronics.

You build advanced equipment while you learn Electronics principles and applications.

Each week brings new excitement when you actually see the progress you've made.

NTS builds self-confidence.

For a man to become successful, like James Gupton, he must have confidence in himself.

As an NTS graduate you have this confidence. Your training is practical and thorough. You know Electronics from the bottom up. You enter a world of Electronics you're familiar with.

And if you have the drive and determination of a man like James Gupton, there are no limits on your success!

(James Gupton's address available upon request).

NTS COLOR TV SERVICING



Solid-state
315 sq. in.
Heath Color TV

Build and keep the largest, most advanced color TV made! Over-all solid-state design, ultra-rectangular screen, matrix picture tube, built-in self-servicing features, "Instant On," A.F.T., solid-state, 24-channel detent UHF/VHF power tuning, and much more! Also build and keep AM-SW Radio, solid-state Radio, FET Volt-Ohmmeter, and Electronic Tube Tester. Learn trouble-shooting, hi-fi, stereo, multiplex systems, radio, color and B&W TV servicing.

NTS B&W TV SERVICING

Learn sophisticated solid-state circuitry as you build this B&W TV Receiver, Lo-Silho "Superhet" Radio, FET Volt-Ohmmeter, solid-state Radio, Electronic Tube

Solid-state
B&W TV,
74 sq. in.
picture
(cabinet
included)



Big, Colorful NTS Guide to new opportunities in Electronics. Yours FREE!

NATIONAL TECHNICAL SCHOOLS
4000 S. Figueroa Street
Los Angeles, California 90037

Please rush me FREE Color NTS Electronics Guide & FREE lesson, plus information on course checked at right. No obligation. No salesman will call.

Checker, and Signal Generator. TV and all other equipment are yours to keep.

NTS ELECTRONIC & COMPUTER TECHNOLOGY

Solid-state Compu-Trainer 14 integrated circuits replace 198 Transistors!

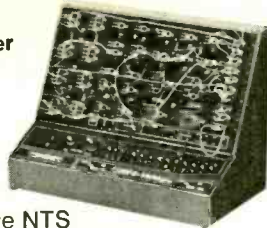

Build and keep this exclusive NTS Compu-Trainer. It teaches you the same principles used in million-dollar systems. Contains 14 integrated circuits! All solid-state! You perform all wiring and patchcording. No shortcuts. No pre-wired circuit boards. Your training is complete! Also receive a FET Volt-Ohmmeter and a 5" wide-band solid-state Oscilloscope.

NTS ELECTRONIC COMMUNICATIONS

Gain the prestige and earning power of owning and F.C.C. First Class Radio-Telephone license. Two comprehensive NTS Courses cover the big opportunity field of transmitting and receiving.



5-watt AM
Transmitter/
Receiver

You build and keep 14 kits, including this amateur phone 6-meter VHF Transceiver, NTS's exclusive 6-transistor solid-state Radio, and a fully transistorized Volt-Ohmmeter. Also, learn 2-way radio, Citizens Band Microwaves, and radar.

NTS INDUSTRIAL & AUTOMATION ELECTRONICS

Automation is the future of industry, and you can play an important part! Learn industrial controls by training on the NTS Electro-Lab (a complete workshop). You also build and operate this 5" solid-state

oscilloscope. And you perform experiments that involve regulating motor speeds, temperature, pressure, liquid level, and much more. All equipment is yours to keep.



All solid-state!

NTS AUDIO ELECTRONICS SERVICING

Learn sound theory — how it works in home radio, car tape decks, stereo multiplex component systems, and more! Set up a spectacular music system. Learn about sound distortion, amplification and control, loud-speaker baffles, problems of system installation, etc.

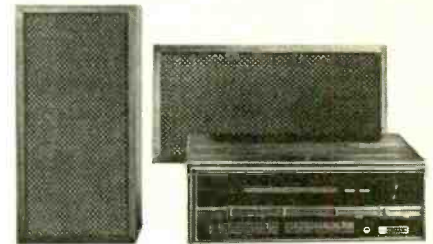

Build and keep this famous Heath Stereo Receiver and Speakers

Included is Volt-Ohmmeter, In-Circuit Transistor Tester and solid-state Radio. Prepare yourself for great opportunities in the Home Entertainment Industry!

CLASSROOM TRAINING AT LOS ANGELES

You can take classroom training at Los Angeles in sunny Southern California. NTS occupies a city block with over a million dollars in technical facilities. Check box in coupon below.

APPROVED FOR VETERANS

Accredited Member: National Association of Trade and Technical Schools; National Home Study Council.

NATIONAL TECHNICAL SCHOOLS

Resident & Home Study Schools
World-Wide Training Since 1905
4000 S. Figueroa St., Los Angeles, Ca. 90037

Dept. 206-112

NAME _____ AGE _____

ADDRESS _____

CITY _____

STATE _____ ZIP _____

- Check if interested in Veterans Training under new G.I. Bill.
 Check if interested ONLY in Classroom Training at Los Angeles

- MASTER COURSE IN COLOR TV SERVICING
 COLOR TV SERVICING (FOR ADVANCED TECHNICIANS)
 MASTER COURSE IN B&W TV & RADIO SERVICING
 MASTER COURSE IN ELECTRONIC COMMUNICATIONS
 PRACTICAL RADIO SERVICING
 FCC LICENSE COURSE
 MASTER COURSE IN ELECTRONIC TECHNOLOGY
 AUTOMATION & INDUSTRIAL ELECTRONICS
 COMPUTER ELECTRONICS
 BASIC ELECTRONICS
 AUDIO ELECTRONICS SERVICING

step-by-step

TV TROUBLE

The sound module in a IC and associated

by ART MARGOLIS

THE SOUND CARRIER IN THE COMPOSITE TV signal is troublesome. It is positioned only 920 kHz away from the color subcarrier. When it mixes with the color it produces a beat that can drive right through the video amplifiers into the color display. Just a tiny amount of sound can do this. As a result TV engineers do everything possible to get rid of the sound carrier before and after the video detection. There is little or no problem with the beat between the video carrier and color subcarrier which are 3.58 MHz apart.

Inside the sound module

In a typical solid-state color TV, the sound pickoff can be in the output second i.f. This permits placing a 41.25-

MHz sound trap into the third i.f. input. Taking the sound off at the second i.f. presents a problem. The sound is quite weak and has to be beefed up before it can be fed to the sound-detector. This is done in the sound-detector amplifier. It mixes the 41.25-MHz sound carrier and 45.75-MHz video carrier, producing an amplified 4.5-MHz sound output for the detector. The sound-detector amplifier acts like a third i.f. stage for the sound only.

Next in line, in some sets, is a sound module. In the Zenith it has five terminals and a ground strap. Its heart is an IC chip. Also in the module are inductive devices that cannot be installed in an IC.

The chip is a "black box" type of thing containing the detector and audio

amplifier. The 4.5-MHz output from the sound-detector amplifier enters one terminal of the module and passes through a 4.5-MHz transformer.

Transformers or coils cannot be formed inside a chip so they are discrete components on the module. The 4.5-MHz sound-pickoff transformer is conventional and picks the 4.5-MHz intercarrier frequency out of the mess of frequencies heterodyned inside the detector amplifier circuit. The 4.5-MHz signal is applied directly into the chip. A limiter and an FM sound-detector are inside the chip. The 4.5-MHz and quadrature transformers and all other parts

VOLUME CONTROL CIRCUIT

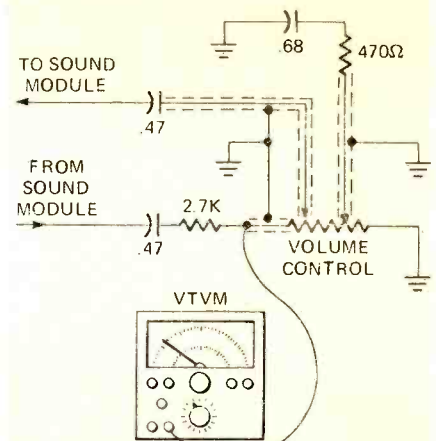

CHECK THE SIGNAL leaving the module to find out if it is operating.

shown outside the outlines of the IC and discrete components on the sound module.

The B-plus (24 volts) is applied through a series resistor and is bypassed with a couple of capacitors, a routine .05 and a 100- μ F 25-volt electrolytic. The volume control and audio output are hooked conventionally onto the chip. Audio comes out of the chip.

Distorted or weak audio makes the sound module a suspect. It has to be tested, but how?

The first step is to eliminate the audio output stage and speaker by feeding

TYPICAL SOUND MODULE (ZENITH)

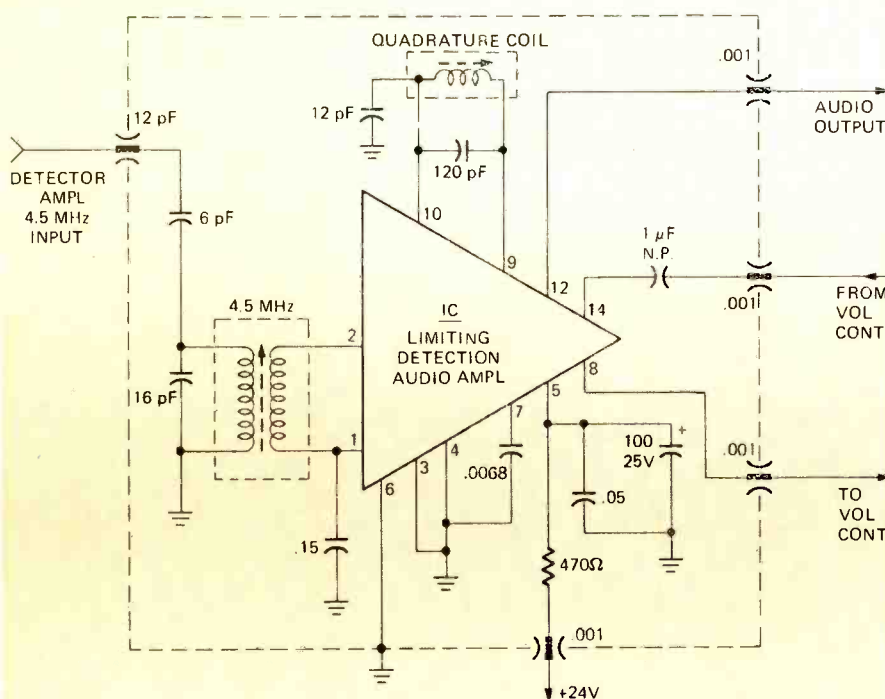

COMPLETE SCHEMATIC OF A TYPICAL SOUND MODULE. This one comes from a Zenith TV receiver. Note that there's a lot more than just an IC to go wrong.

SHOOTER'S GUIDE

solid-state TV set may consist of only a single components. Here's how to troubleshoot it fast

an audio signal into the output stage and listening for distortion. If all is well, the trouble may be in the audio module. The IC cannot be investigated on its own. It must be tested with input and output tests. You must apply signals and by observing what happens to the signal as it leaves the chip decide what to do about trouble. The chip is tested primarily for its ability to limit and detect the incoming FM signal.

Take a 4.5-MHz signal and apply it to the sound-module input. Attach a vtvm (on a low scale) to the module output at the volume control. The unmodulated 4.5-MHz input should pro-

duce little or no dc output voltage since there is nothing to detect. Then vary the 4.5-MHz generator frequency slightly to either side of center. That sets up an imbalance in the FM detector, some dc voltage is developed as if it was modulation. The dc scale will read some voltage either side of the center frequency. If it does, the chip is detecting.

To test the limiting action, turn up the output on the generator. Set the generator frequency on one side of the center frequency to produce a reading. As the generator output is turned up, the dc voltage will rise until it reaches the limiting point of the chip. From

there on in, turning up the output will produce no more dc voltage. If this occurs, the chip passes its limiting test.

When you cannot cause detection, limiting or both, the sound module is the source of the trouble. Adjust the cores in the sound i.f. and quadrature transformers to peak performance. Quite often the cores will be out of adjustment and by aligning the two cores for good detection and limiting the repair will be made. Otherwise the problem boils down to, is the chip defective or is a discrete component bad? The trouble chart procedure leads to the suspects. **R-E**

SYMPTOM - DISTORTED OR WEAK AUDIO, PIX OKAY

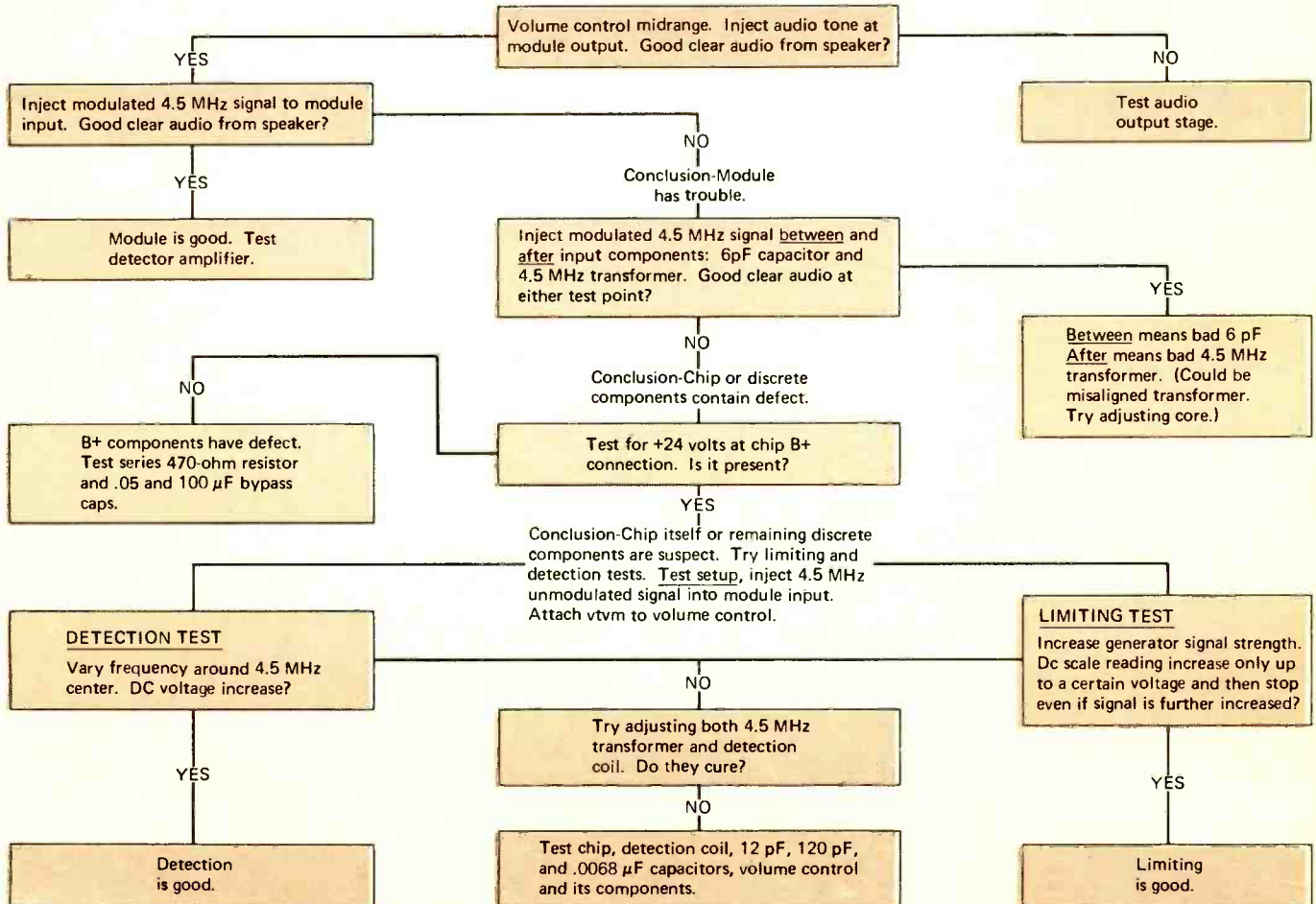

technical topics

Four off-beat circuit applications you can use.
Most unusual is the multivibrator-type i.f. sweep gen.

by ROBERT F. SCOTT
TECHNICAL EDITOR

SELECTING MATERIAL FOR THIS COLUMN can be frustrating. We never know whether the material selected will interest most of you. Some months back, you indicated that you like *Technical Topics* and want to see it more often. I have a constant fear of saturating you with material that turns you off. This is your column so why make me play guessing games? Drop me a line and tell me just what subjects interest you and what type of material you'd like to see.

We gather our material from application notes and limited-circulation and foreign magazines so it may take a while to work up material on *your* pet subject. If enough of you tell me what you want, we'll be able to get it and even tell you when it will appear. Meanwhile, here are a few circuits that you may want to adapt for your own needs.

Unusual i.f. sweep generator

The response of i.f. strips, bandpass filters and various forms of FM detectors can be checked and corrected, if necessary, by using a sweep generator and a scope. Most sweep generators consist of an rf *sinewave* oscillator whose frequency is swept about a center point by a reactance tube, an In-creductor (voltage-variable inductor) or a variable-capacitance diode.

In a recent issue of *Radio Communication*, G8CGA points out that a sine-wave source is not necessary when checking the response of high-Q tuned circuits. The prime requisite is a signal whose amplitude is constant over the swept range. Fig. 1 is the circuit of a sweep generator using a saturating-type multivibrator oscillator. The frequency is varied about the center point by applying a sawtooth voltage as bias to the base of Q2. The sawtooth excitation voltage is tapped off the scope's sweep oscillator and fed to the common base circuit through the DEVIATION control. The value of resistor R1 is determined by the magnitude of the sawtooth from

the scope. It should be about 40,000 ohms for each 10 volts peak-to-peak of sweep voltage. The output signal level is controlled by a 3-step attenuator and a 1000-ohm pot for smooth control.

With the values shown, the multivibrator can be tuned from about 440 to 550 kHz. Frequencies as high as 20-30 MHz can be covered using adequate transistors and adjustments in circuit constants.

When using the sweep generator, set the scope sweep-speed control for the lowest rate that can be used without objectionable flicker on the trace. In any event, the response curve will be distorted if the sweep rate is too high. Start with a very slow sweep and increase it to the point where the trace

starts to distort and then back off a hair.

Micropower on-off indicator

The absence of a power on-off indicator has long been a major disadvantage of solid-state battery-powered devices. Although the power drain is so low that it has negligible effect on battery life, it is still disturbing to find that a battery-powered device has been left on for days, or even weeks. The light-emitting diode, or LED, is a miniature low-voltage, low-power device that makes an ideal pilot light.

The circuit in Fig. 2 is a novel pilot indicator recommended for installation in a solid-stage vom described in *Electronics Australia*. It runs off a 9-volt battery and draws an average of somewhat less than 2 mA.

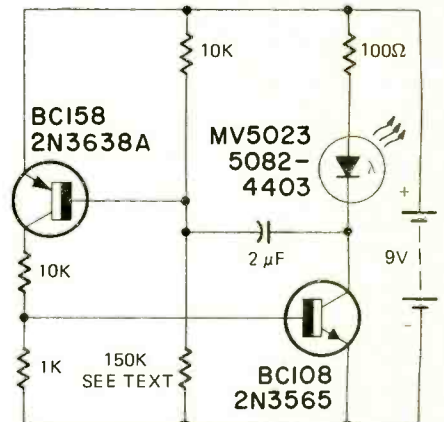
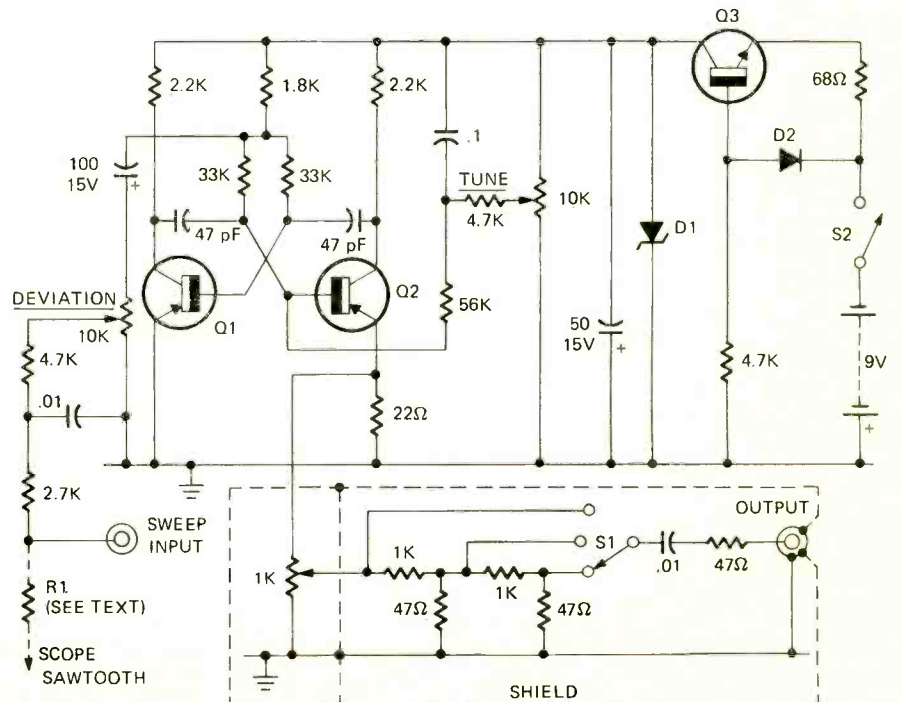

FIG. 2—LED IS PILOT LAMP for battery-powered test instrument. Transistor multivibrator pulses LED for more brightness.



Q1, Q2 = BFX12, GE-12, HEP-52, ETC.
Q3 = GE-7, HEP-641, ETC.
D1 = 6.1V ZENER
D2 = GE-504A, HEP-156, ETC.

FIG. 1—MULTIVIBRATOR SIGNAL GENERATOR delivers sweep signal for i.f. circuit alignment.

The LED, Monsanto MV 5023 or Hewlett-Packard 5082-4403, is in the collector load circuit of a multivibrator that pulses the light on and off approximately 10 times per second. (LED's provide higher light output when pulsed and the eye is more sensitive to flashing light so the pulsed LED makes an ideal power-on indicator.)

The critical components in the circuit are the capacitor and the 150,000-ohm resistor. The capacitor must be a low-leakage type such as a polyester or metallized polyester. The 150,000-ohm resistor may have to be adjusted for

proper operation. If it is too low the circuit will not oscillate and the LED won't light. Too high; both transistors remain conducting and the LED lights continuously.

Versatile lab power supply

A good wide-range power supply is essential to every experimenter and service technician's workbench. One of the most versatile we've seen was described in *Radio Elektronik Schau*. It consists of two identical 0-25-volt, 1-ampere supplies that can be used alone or switched in series to deliver up to 50 volts dc.

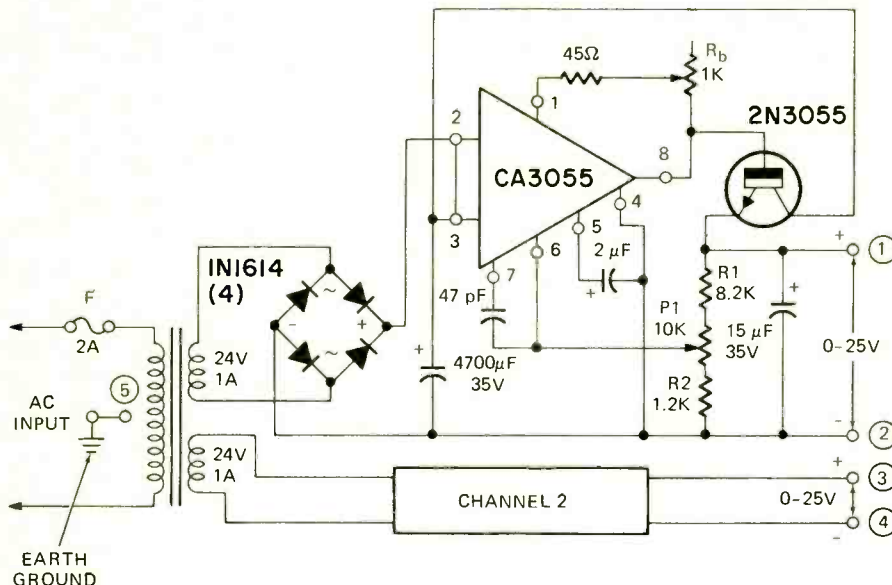

FIG. 3—BASIC DUAL POWER SUPPLY FOR LAB OR BENCH feeds two separate 25-volt loads or one load at 50 volts. Metering and switching circuits are illustrated in the next figure.

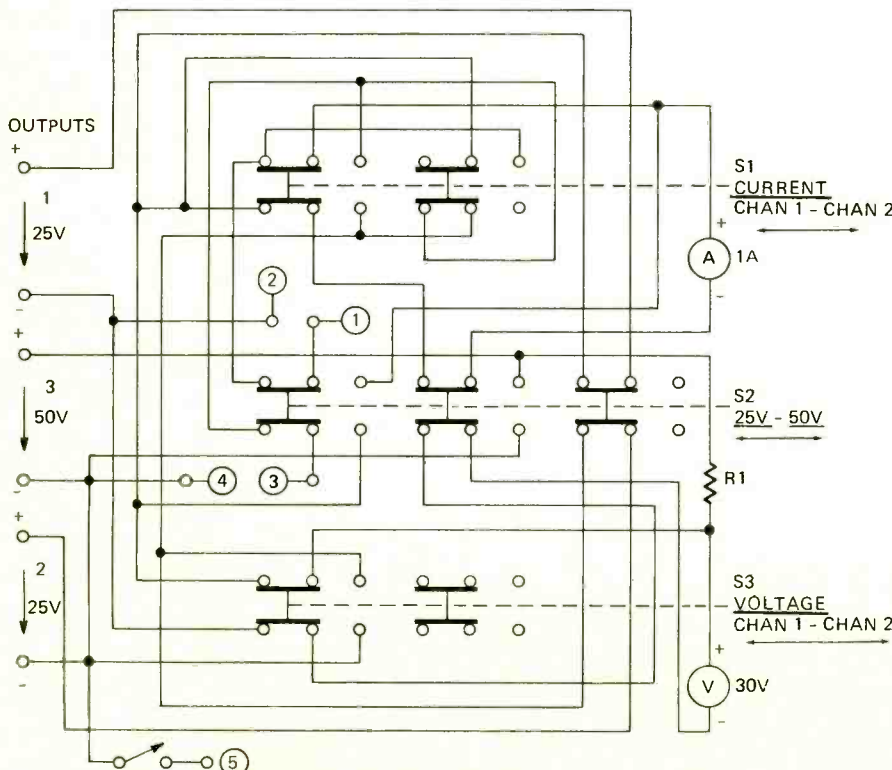

FIG. 4—HOW SUPPLIES AND METERS ARE SWITCHED. Terminals indicated by circled numbers correspond to those on the dual supply in Fig. 3. Switches may be slide, rotary or pushbutton types.

The active circuits in the supply are shown in Fig. 3. One of the supplies is represented by the schematic, the other by the block diagram. Voltage control and adjustment is provided by the CA3055 IC and 2N3055 transistor. Current and voltage can be read on built-in 1-ampere and 30-volt dc meters. Figure 4 shows the switching that accounts for much of the versatility of this instrument. S1 switches the ammeter to either supply when used separately while S3 switches the voltmeter similarly. Slide switch S2 is used to connect the two supplies in series for up to 50 volts output. A multiplier resistor (R1) is switched with the meter to double its range to 60 volts dc. The resistance of the multiplier should equal the meter's internal resistance.

Solid-state ratchet relay

A ratchet relay is normally specified when we need a sequential on-off operation from a simple pushbutton switch, as when operating a light or similar device from several remote points or for the send-receive circuits of a two-way radio setup.

The circuit in Fig. 5 is an electronic

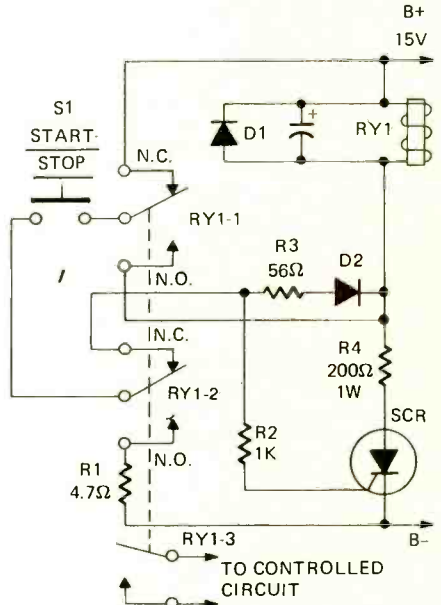

FIG. 5—HYBRID SEQUENCING CIRCUIT. The SCR latches on and off on consecutive closures of momentary switch S1.

ratchet relay described in *The Radio Constructor*. The device consists of a SCR and a 500-ohm relay with a pair of spdt contacts and a normally open spst contact to handle the load. The relay contacts are shown as they are when the SCR is turned off and the relay coil is not energized.

When the pushbutton is first pressed, a triggering pulse is fed to the gate through relay contacts RY1-1 and RY1-2 and the SCR fires. The bottom end of the relay coil connects to B+ through D1, R3, S1 and relay contacts

RY1-1 and RY1-2 so only a small portion of the SCR's anode current flows through the relay coil and most of the voltage is dropped across R4. Current through the coil is too low to actuate the relay.

As the pushbutton is released, gate voltage is removed from the SCR and the low end of the relay coil is no longer tied to B+. The voltage across the coil now rises high enough to actuate the relay, switching contacts RY1-1 and RY1-2 and closing load contacts RY1-3.

The next time the switch is pressed, the bottom end of the relay coil is shunted to ground through the normally open contacts of RY1-1 and RY1-2 and a major portion of the SCR supply voltage is shunted to ground through R1. The SCR anode current drops below the holding-current level and conduction stops. The relay is held in because the bottom end of its coil is now connected to B- through the normally open contacts and R1.

Releasing the pushbutton breaks the circuit through the coil, releasing the relay, opening the load contacts and readying the circuit for the next operation.

The circuit can be checked for correct operation by metering the voltage across the relay coil. It rises from zero to 4 volts when S1 is pressed for START or ON and rises to 11 volts when the button is released. Voltage rises to 15 when the button is pressed for STOP or OFF and drops to zero when the switch is released.

A maximum current of about 50 mA is drawn when S1 is pressed to START and then drops to 22 mA for as long as the controlled device is on. Current drain is zero when the controlled device is off.

Diodes D1 and D2 are small silicon rectifiers. We do not have any technical data on the type CRS1/05 SCR but it is a small plastic device in a TO-5 can. Any low-current SCR should work nicely.

Well, that's about it for now. Don't forget to let me know what you'd like to see in future columns. **R-E**



But it is an emergency, Officer. No picture, weak sound, and there's a great football game on this afternoon.

equipment report

International Crystal's FM-2400-CH frequency meter



Circle 23 on reader service card

THE FIRST REQUIREMENT FOR A FREQUENCY meter is accuracy. The second is ease of operation. The International Crystal FM-2400-CH frequency meter meets both of these with ease. Twenty-four different crystals can be used, covering all bands from 25 to 1,000 MHz.

For accuracy, each crystal meets or exceeds FCC standards with a *minimum* accuracy of $\pm 0.001\%$. (The typical crystal is checked to an accuracy of $\pm 0.0005\%$.) Stability is $\pm 0.0005\%$ between 32 and 122°F. The 25 to 54-MHz vhf band, and high-band crystals are calibrated to these standards. The uhf band crystals (450 MHz band) are calibrated to $\pm 0.000125\%$.

A special chart is provided for each crystal. The FREQUENCY-ADJUST dial is set to a correction factor determined by the ambient temperature. An accurate thermometer is provided, in the knob of the FREQUENCY ADJUST dial. A vernier on this scale allows setting to very close tolerances.

For ease of operation, this is a dandy. It's the simplest instrument of its type that I've ever used. Measurements can be taken with ease, on any kind of transmitter. Coupling to the transmitter isn't critical; the FM-2400-CH has ample sensitivity to make usable read-

ings without a lot of trouble.

All you have to do is place the instrument near the transmitter, check the temperature and the chart for the desired crystal, and make the setting. While you're doing this, the transmitter is warming up. Push the key and note the reading, with the frequency meter set to RF; this is just to assure you that there is a signal present. Only a small amount of signal is needed to get an accurate reading. On the other hand, this instrument will read fairly high signal levels without trouble.

To read the actual frequency of the transmitter, the dial is set for FREQUENCY DEVIATION, and both the transmitter and frequency meter are turned on. The amount of frequency error is read directly on the meter dial in kHz. If the transmitter is right on the button, the needle won't move.

Three different sensitivity ranges are provided; X3, X1 and X0.3. The meter reading is multiplied by the factor indicated, X0.3 being the most sensitive. You can find the exact frequency of the transmitter, if it is off, by turning the FREQUENCY ADJUST dial, and noting which way you have to go to get the zero-beat.

The FM-2400-CH can also be used to check and align the receivers in any system. Since the same crystal is used for both transmitter and receiver testing, this makes accurate "netting" of any system fast and accurate. (*Netting*—adjusting all receivers and transmitters in a radio system to precisely the same frequency.)

Since the FM-2400's 24 crystals can each be used for a single system, this allows the testing of 24 different radio systems without the need for more crystals. Modulation of the transmitter can be checked by noting the increase in meter reading, in the RF position, when the transmitter is modulated. An earphone jack is provided on the panel for listening to it, or for checking zero-beat, etc.

The FM-2400-CH is powered by two 6-volt NiCad batteries. A charger is part of the "package." It is installed on the bench, and the instrument can be left plugged into it at all times. The charging rate is regulated and the con-

(continued on page 102)

INSIDE THE RUFF GEN, a handy test oscillator that you can build to meet your needs. Parts are inexpensive and most are not critical.

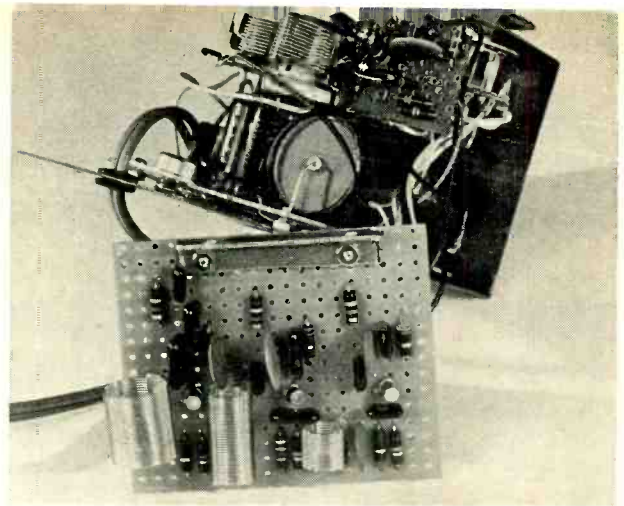

SIGNAL GENERATOR APPLICATIONS

An rf signal generator is much more than a mere alignment tool. Here are some uses that'll lead you to develop others.

By JIM HUFFMAN

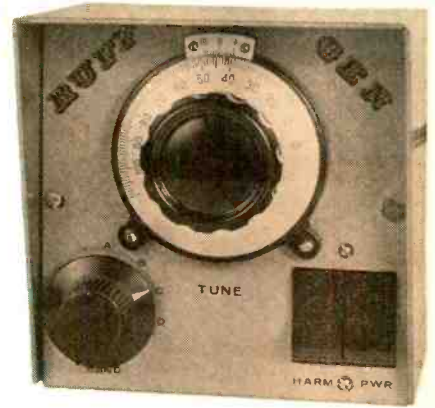

THE SIGNAL GENERATOR IS ONE OF those everyday instruments that has literally thousands of applications. Thirteen interesting uses are described in detail in this article. In addition, we will show you how to build a basic signal generator of your own.

The first group of eight generator applications will primarily interest the experimenter. Here we go:

1. Heterodyne Frequency Meter

Although the signal generator is a reliable source of known frequencies, it has little value when checking the output frequency of a frequency generating device such as an oscillator. By adding the circuit shown in Fig. 1, you can convert the signal generator to a heterodyne frequency meter. The unknown signal is applied to the input of the frequency meter and the signal generator is tuned until the two signals zero beat. At zero beat, you simply read the unknown frequency from the signal generator. Note: when an rf heterodyne meter arrangement is being used, make sure you are not reading a harmonic of the generator. It is a good idea to know the approximate frequency range for the unknown signal to insure a harmonic is not being used. (Using the "Ruff Gen" here eliminates the worry when using the sinusoidal output.)

2. Grid Dip Meter The circuit shown in Fig. 2 doesn't make the generator into an actual "grid" dipper, but it

does function in the same way. When the loop is brought near a resonant circuit and the signal frequency is tuned to

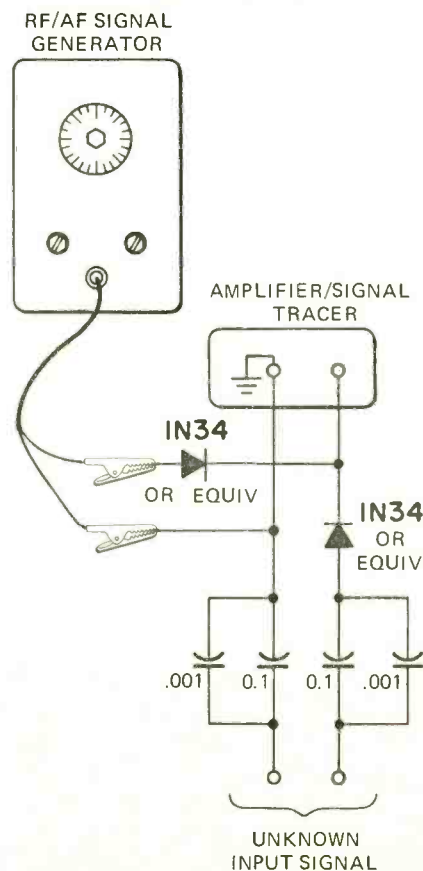

the resonant frequency of the network, the meter indicates a dip showing the tuned circuit loading the output of the signal generator. You can also connect the generator output leads directly across a tuned circuit and look for a rise on a suitable ac voltmeter.

FIG. 1—HETERODYNE FREQUENCY METER. The signal generator can be used as a heterodyne frequency meter with this circuit. The .001- μ F capacitors work at rf, while the .1- μ Fs couple audio. Make sure the unknown input signal is about the same level as the rf generator output. Both should be somewhere between 0.5 and 1.0 volt.

FIG. 2—GRID DIPPER. You can find resonant frequencies, unknown C and L, and many other values when you add this circuit to a signal generator. Optimize L1 for your generator and top frequency you wish to use.

TO RCVR INPUT (S-METER INDICATOR) RF VOLTMETER, OR METERED AMPLIFIER WITH RF DET.

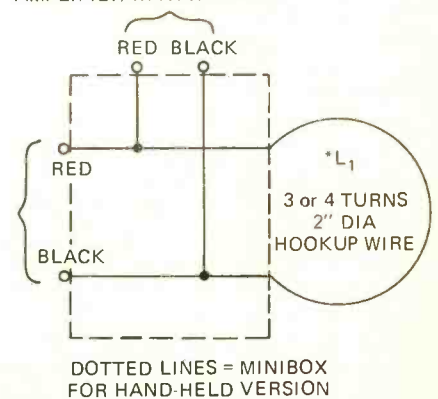

3. Input/Output Impedance Measurements By using the arrangement shown in Fig. 3, you can use the signal generator to measure the input and output impedances of amplifiers. Fig. 3 shows how to measure input impedance. Variable resistor R_z is adjusted until the output voltage reads one-half the maximum value. The value of the variable resistor is measured at this point and this value is approximately the same as the input impedance. Of course, this method does not give the imaginary components of the impedance.

Fig. 3-b shows how the output impedance is measured. Again, adjust for one half the maximum reading. This

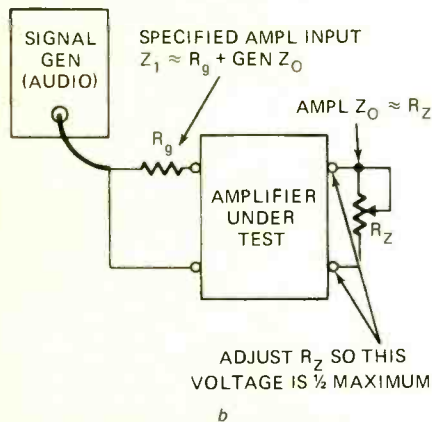
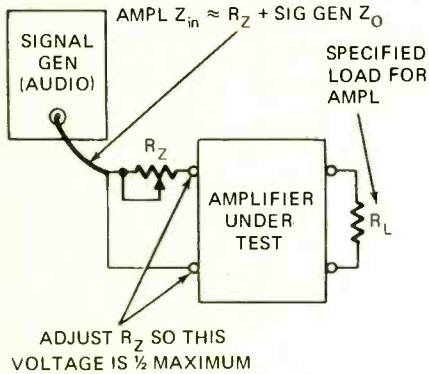

FIG. 3—INPUT/OUTPUT IMPEDANCE MEASURING. (a) above setup used to measure Z_{in} (for any 4-terminal network). (b) is the Z_{out} setup. In either arrangement, the signal generator must have adequate output to drive the amplifier under test.

time the resistor reads the output impedance. This method will work for any amplifier whether one-stage or multi-stage.

4. Frequency Response The signal generator can be used to measure the frequency response of an amplifier or network. Merely find the two points at which the output voltage is 0.707 times the maximum value. In other words if an amplifier's maximum output voltage is 1 volt and the generator frequency is 50 Hz and 100 kHz before the signal drops to 0.707 volt, then the response is -3 dB from 50 Hz to 100

kHz. If the meter reading varies little between these ranges, then the amplifier is essentially flat between the upper and lower cutoff frequencies. On the other hand, there may be points within the 50-100 kHz at which the voltage drops to or below the 0.707 volts and the output is not flat between these ranges. Make sure the output of the signal generator is constant, this may mean occasional readjustment of the output level of the generator.

5. Transformers Signal generators let you determine the transformer turns ratio at the frequency for which the transformer is designed. Merely insert the proper frequency at a given input level to the transformer, say, 1 volt. Measure the output voltage and set up a ratio of input volts to output volts. In the example: 1 volt to X volts. The transformer turns ratio is then 1:X. If the output voltage (X) is 2 volts, the ratio is 1:2. If the transformer is a power type, 60 Hz: in operation with 110 Vac in, the output voltage would be 220 Vac.

You can also check transformer efficiency by connecting the signal gener-

extremely stable and has no harmonic output.)

7. Transmitter To the rf generator with modulated output, you can add the vfo circuit shown in Fig. 4 and modulate for an AM transmitter. This is a milliwatt input job. The input to the buffer stage can be held at less than 100 mW by adjusting the drive. This means the generator can be used legally with no license on the AM broadcast band, Citizens band, or television audio. If you hold a proper ham ticket, you can use the outfit on the amateur bands for a QRP (low power) rig. QRP operation is fun in these days of 2 kW linears.

8. Strobe Light Driver The audio generator can be used as sort of a visual tachometer in that it can be used to drive a strobe light. When the generator frequency coincides with the mechanical frequency, motion freezes. Don't figure on stopping the motion completely, as the phase of the light and motor drift somewhat. And don't forget to convert revolutions-per-minute to cycles-per-second. Just multiply the audio frequency by 60.

BAND	L1	C1	C2	C3
80	5 μ H	500 pF	.01	.1
40	3 μ H	250 pF	.01	.01
20	5 μ H	25 pF	.001	.005
15	.8 μ H	80 pF	.001	.001
10	.5 μ H	50 pF	.001	.001
8 MHz*	2.5 μ H	250 pF	.01	.01

* (6 & 2 METERS)

2N697

HEP 50, ETC.

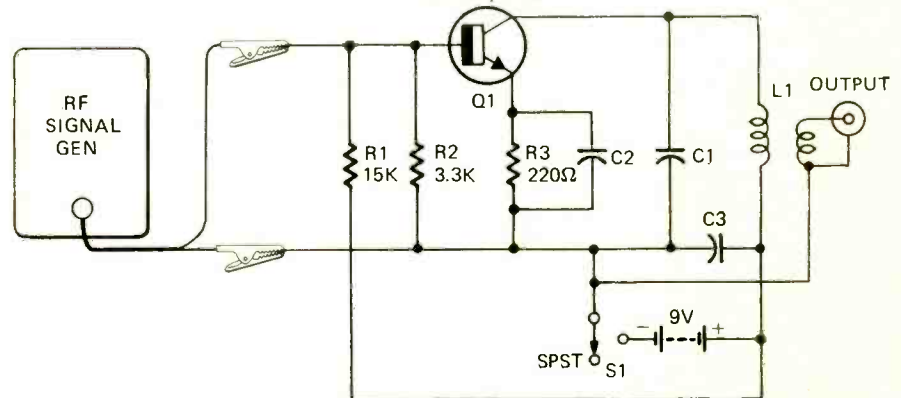

FIG. 4—SIGNAL GENERATOR VFO. The signal generator makes a decent VFO with the addition of a buffer. Q1 can be almost any npn transistor that will work at the highest output frequency you plan to use. You can even use a pnp transistor if you reverse the battery polarity.

ator to the primary, with the prescribed load on the secondary. Now calculate the power in the primary and secondary ($P = E^2/Z$). Where Z primary is equal to the load resistance times the turns ratio squared. Transformer efficiency is given from $\%(P_{out}/P_{in})$.

6. VFO Connect a buffer between the rf signal generator and the input of the transmitter (Fig. 4). The coil and capacitor LC are there to filter out spurious outputs from your generator. Coil and capacitor data are given in the table. (Note. The Ruff Gen may be used directly in this application because it is

Technician applications

1. Check The Condition Of Capacitors Just connect the capacitor in series with generator output and your meter. Now sweeping the generator from low to high frequencies should produce low to high output voltage variations. But if the output is constant, the capacitor is open. If you have trouble reading the outputs or cannot detect changes too well, try connecting a 1000-ohm resistor across the meter terminals.

2. Inductor Checker Inductors can be checked in the same manner as

capacitors. As the frequency goes up, the impedance of the coil goes up, and the voltage at the meter goes down. Use the 1000 ohm resistor if you do not obtain very substantial readings at first.

3. Sweep It If you don't mind going inside your rf generator, add a Vari-cap sweeper. This changes the frequency when a unijunction supplies a variable sweep voltage. Fig. 5 shows the schematic of such a sweeper. If you cannot gain enough sweep range, use a 1N5148 varactor.

4. FM Source With the circuit of Fig. 5 and your rf signal generator you have a source of FM that can be used to check out FM receivers. The circuit works on the same principle as the electronic sweep generator except consider the input as audio and not sweep signals. The audio will be adjustable from about 1 to 2 kHz (ignore the sweep output to the scope).

5. Horizontal Bar Generator The standard rf generator with 400 Hz signal modulation will produce horizontal bars on a television receiver. This signal simplifies vertical linearity and height

FIG. 5—SWEEP ANY RF GENERATOR by adding this simple circuit.

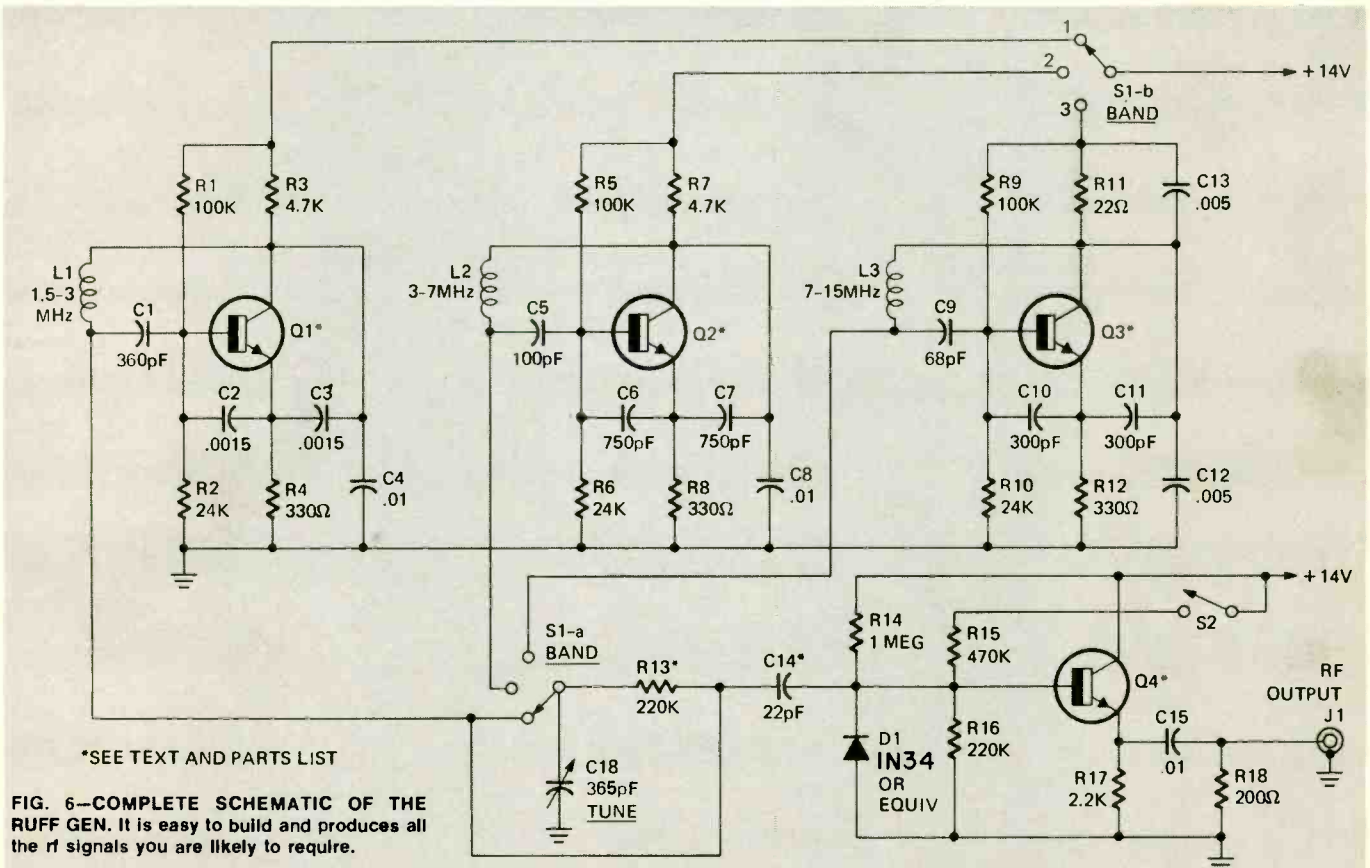
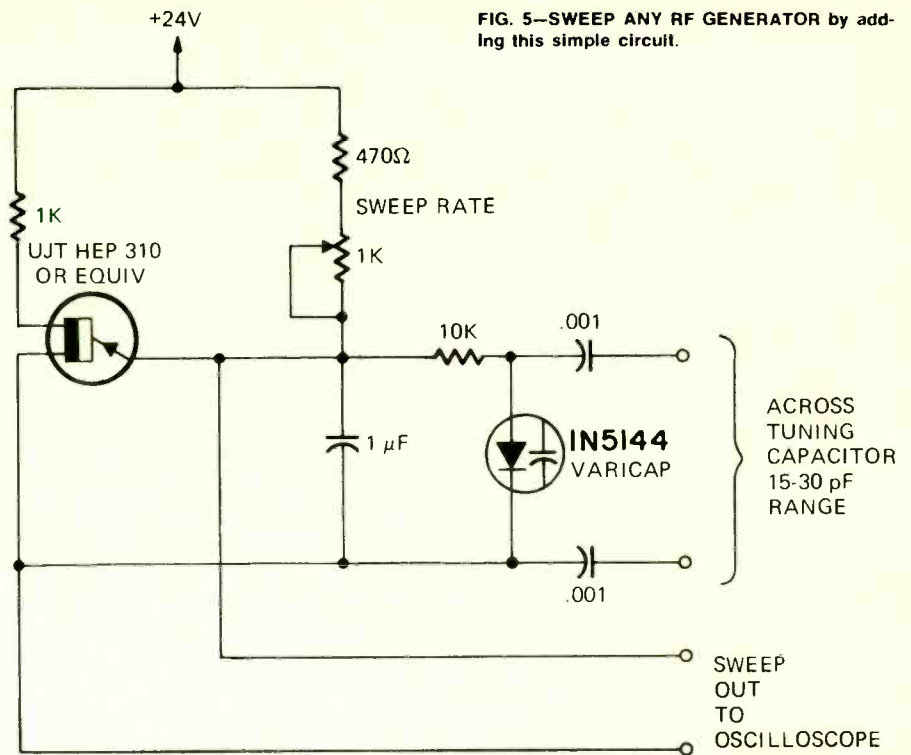

*SEE TEXT AND PARTS LIST

FIG. 6—COMPLETE SCHEMATIC OF THE RUFF GEN. It is easy to build and produces all the rf signals you are likely to require.

PARTS LIST

- All resistors 1/2-watt 10% unless noted
- R1, R5, R9—100,000 ohms
 - R2, R6, R10—24,000 ohms
 - R3, R7—4700 ohms
 - R4, R8, R12—330 ohms
 - R11—22 ohms
 - R13, R16—220,000 ohms
 - R14—1 megohm
 - R15—470,000 ohms
 - R17—2200 ohms
 - R18—200 ohms (5%)
 - R19—1000 ohms

- All capacitors silver mica unless noted
- C1—360 pF
 - C2, C3—.0015 μF, at least 50V, ceramic
 - C4, C8, C15—.01 μF ceramic
 - C5—100 pF
 - C6, C7—750 pF
 - C9—68 pF
 - C10, C11—300 pF
 - C12, C13—.005 μF ceramic
 - C14—22 pF
 - C16—2000 —F, 50 V, electrolytic
 - C17—1000 μF, 15 V, electrolytic
 - C18—365 pF variable (1 5/16" x 1 3/8" x 113/16D). See text

- D1—1N34 or equal
- D2—50 V, 1A, full-wave bridge
- D3—400 mW, 12 - 13 volt Zener
- L1—27 turns B&W 3012 (1/4" dia x 32 tpi)
- L2—34 turns B&W 3004 (1/2" dia x 32 tpi)
- L3—14 turns B&W 3004 (1/2" dia x 32 tpi)
- Q1, Q2, Q3, Q4—2N914 or equal
- Q5—15W silicon npn power transistor
- S1—2 pole, 3 position rotary (see text)
- S2—double rocker switch (spst/spst)
- T1—24 V 500 mA transformer (sec), 117 Vac (pri)
- MISC—perf board, hardware, knob, 5 x 5 x 5 box, 3" dial, BNC jack, grommets, line cord

adjustment. Connect the rf generator output directly across the TV's antenna terminals. Then adjust the frequency until the bars appear. Now adjust the vertical linearity (and height) controls till the bars are evenly spaced up and down on the screen.

Building the Ruff Gen

Now that you have been introduced to some uses for the signal generator, it's time to get one. If you don't already have an rf signal generator, the Ruff Gen would be ideal. In fact, some of the features of the Ruff Gen might make you want to supplement your existing signal generator with this one. The circuit was originally designed when a source of nearly sinusoidal rf energy was needed. If you have ever used a commercial signal generator, you know that the output is anything but sinusoidal. Also, stability is somewhat wanting in the cheaper commercial units so this rf generator also fills this gap. Speaking of cheaper, we have the third reason for building this unit. It is less expensive than many units.

Since the rf generator only operates on fundamentals to about 15 MHz and it is sometimes desirable to use it above this range, harmonic generation capability is included. The normal sine-wave output of the generator is distorted at

power on/off switch, the power supply is "on" as long as the unit is plugged in. The only real advantage here is the creation of the heat from the regulator which tends to stabilize the temperature inside the generator. The heat also prevents moisture buildups when the case temperature undergoes one of the rapid excursions sometimes associated with a garage workshop.

Since one of the primary considerations is that the unit be inexpensive, the entire unit was designed around the bargain pages of a mail-order catalog. Almost everything needed can be found there, excluding the case, etc.

Construction hints

Perf-board is used throughout, but a printed circuit could easily be fabricated since the wiring has no crossovers.

Three boards make up the unit. They are the power supply, oscillator, and amplifier boards. Each board is mounted within the case on angle brackets fabricated from a defunct utility box. Note the transformer mounting method. The transformer was the cheapest/best unit available, but there appeared to be no way to mount it on a board. Mounting was finally solved by pushing some no. 22 solid hookup wire through the holes at the four corners of the transformer. The wires are simply looped around and then soldered for a

switch specified in the parts list.

The variable capacitor will have to be raised in the air on a strip of aluminum 1 inch wide and 7 5/16 inches long. Bend the strip 3/8 in either side of center down to a 90 degree angle. You should now have a U-shaped bracket. Now put mounting ears on the bracket by bending 3/4 inch of the ends away from the center. Drill for the capacitor and mount. There is actually three way support for the capacitor. Two directions from the mounting ears on the bracket and one way from the vernier dial and capacitor shaft. This capacitor is a common type. Radio Shack's No. 272-1344 looks good. Others can be used with minor alterations in the mechanical layout of the generator.

The rocker switches should be mounted on spacers to recess them in the panel. I got the spacers from the rotary switch that was modified to make a band switch. Letter the front, mount the switches, and vernier, glue some grommets on the bottom for feet and you are in business.

Calibration steps

Calibration is really no problem. Just use the procedure for using the signal generator as a heterodyne frequency meter (Fig. 1), borrow an rf generator from someone and you are all set. Since the ranges should have a slight overlap anyway, no attempt was made to add a calibrate control. You can adjust the value of R13 to achieve a more distorted output (more harmonics) if desired. In fact, there may be some merit in making R13 a potentiometer to allow a degree of harmonic distortion to be controlled at the generator. For more distortion of the lowest frequency oscillator, you would have to increase coupling capacitor C14 which is optimized at 22 pF.

The signal generator in one of its many forms is a helpful addition to the lab workbench. It can check the band-pass of an amplifier, tuned circuit, mechanical filter, etc. It will do any of the other things mentioned in this article and many more that you might think of.

Certainly, constructing your own rf generator is not as challenging as building a receiver, but the versatility of the Ruff Gen should merit the little time and effort that it takes to build it. The Ruff Gen's output is nearly a sinusoid so that it is extremely helpful in determining network response since there are no harmonics to confuse what you see. Harmonics may be added at will when needed merely by switching the output amplifier to a different amplifier mode and thus increasing harmonic distortion.

At any rate, whether you build, buy, or just apply, you will find the extremely handy signal generator a welcome device on your bench. **R-E**

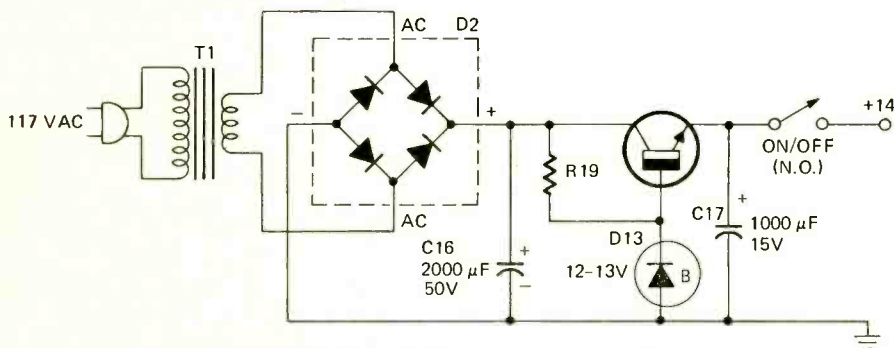

FIG. 7—POWER SUPPLY for the Ruff Gen. It is a simple, yet regulated supply. Note the unconventional position of the on-off switch. See text for explanation.

the flick of switch S2, harmonics can be added when needed. This unit is not modulated, but modulation may be added if desired.

Three separate oscillators are used in the unit for optimum performance. The oscillators are basically Colpitts types. Somewhere a trade-off had to occur because of the multiband feature, and this was in the tuning capacitor. The same 365-pF capacitor tunes all three bands. Figure 6 shows the schematic diagram for the generator. Fig. 7 is the power supply.

Power for the unit is regulated by an emitter follower voltage source; one of the simplest regulators. Actually, the greatest advantage is in the fact that power supply ripple is held to a minimum (around 15 mV). There is no

very stable mounting method. No heat sink is used for the power transistor, since the power dissipated is no where near the available 15 watts the unit can dissipate at room temperature. On the oscillator board the coils are merely glued in place.

Then there is the issue of the switches. In the interest of money; you can order an assortment of rotary switches, in hopes that you find one that would work and restock the junkbox with the rest. I had to remove an spst on/off switch from the switch I used. For only 99 cents, it was a worthwhile experience and it paid off in the form of 9 additional rotary switches (and the spst, too). Should you want to go the more conservative route, you can merely order the 2-pole 3-position

the state of

SOLID STATE

Telephone answering devices, low-power consumption semiconductors, COS/MOS price reductions, power hybrid Darlington, and more

by **LOU GARNER**
SEMICONDUCTOR EDITOR

THANKS TO SOLID STATE CIRCUITRY, electronic equipment is invading industrial areas which, before, were the exclusive province of electromechanical or mechanical devices and, moreover, expanding into commercial businesses where, previously, it had only a precarious toehold. According to economic forecasts at an EIA (Electronic Industries Association, 2001 Eye St., N.W., Washington, D.C. 20006) conference held earlier this year, the total U.S. market for electronic equipment should nearly double between 1975 and 1985, reaching a total of over 80 billion dollars by 1985. In contrast, total 1970 U.S. sales were under 29 billion dollars.

One area where tremendous inroads are being made by electronic equipment is in business offices. A few years back, about the only electronic equipment one would find in such offices—other than a personal radio—was an intercom system. Some offices boasted, in addition, electronic dictating equipment. Today, however, even a relatively small office might have electronic data processing equipment, the familiar intercom system, dictating and transcribing equipment, an electronic calculator, and an electronic automatic telephone answering system. Where part of the office staff may be assigned to field work, the office might be equipped with a two-way radio system to maintain constant contact for information and reassignment purposes.

Currently, electronic telephone answering systems are enjoying a fair-sized boom. More and more businesses are installing these systems, including professionals, such as physicians, attorneys, architects, accountants and engineers, real estate, insurance, stockbroker and construction offices, and even retail and service establishments,

such as stores and repair shops. An automatic telephone answering system can be worth its weight in gold to the radio-TV service technician operating a one-man enterprise. In addition to business applications, quite a few systems are being installed in private homes.

Retail prices range from about \$150 to over \$700, plus installation, depending on the quality of the instrument and the operating features offered. Generally, the more expensive the system, the greater the number of operational options. All currently available systems feature solid-state circuitry and all will answer a telephone automatically with a prerecorded message, afterwards recording an incoming message for later playback. Most provide for monitoring an incoming call while recording.

The more expensive systems may have an automatic counter for incoming calls, two-way recording facilities for outgoing calls, and even a remote query option, permitting the owner to check his accumulated calls from a remote telephone.

Despite the seemingly simple functions provided by automatic telephone answering equipment, their circuitry

can be quite complex, even rivalling that of a color TV set.

By way of illustration, the unit shown in Fig. 1, is a moderately priced instrument that includes many of the features found in more expensive systems. Unfortunately, space limitations prohibit the publication of the instrument's complete schematic, but some idea of its complexity can be gleaned from its simplified block diagram, given in Fig. 2. The instrument's power supply, alone, uses four diodes in a bridge rectifier, a medium-power pass transistor, and an IC operational amplifier to provide regulation. Altogether, this device uses over 40 diodes, 35 transistors, 2 SCRs, and 4 ICs.

Various recording systems are used by different manufacturers of automatic telephone answering equipment. Some use standard cassettes, others reel-to-reel tapes, and still others special cartridges.

If you find automatic telephone answering equipment intriguing, have a knack for solid-state circuits plus mechanical skill, and are an experienced technician looking for other pastures or even a hobbyist with an eye towards a professional future, you may find it worthwhile to investigate the rapidly expanding field of office electronic equipment installation and maintenance. *It's a comer!*

The merry MISER

An interesting semiconductor device being offered by Lithic Systems, Inc. (10010 Imperial Ave., Cupertino, Calif. 95014) is a real miser when it comes to its power requirements. Suitable for use in light flashers, relaxation oscillators, tone generators and timing circuits, the unit can operate with source power drains measured at microwatt



FIG. 1—AUTOMATIC TELEPHONE answering system; the Doro 311.

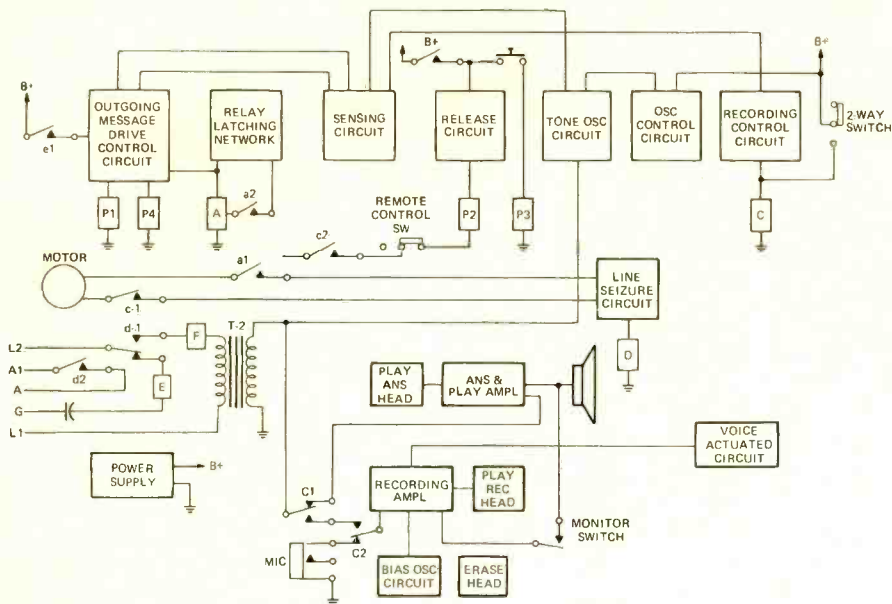

FIG. 2—SIMPLIFIED BLOCK DIAGRAM of Doro 311 automatic telephone answering system.

levels. In fact, it's actually called a MISER, for Monolithic Integrated Stored Energy Regulator. If teamed with a standard LED, the unit can provide performance characteristics comparable to those of a low-voltage neon lamp. Some of its possible applications are truly fascinating—would you believe a light-powered light?

The MISER's functional block diagram is in Fig. 3. It consists of a dc

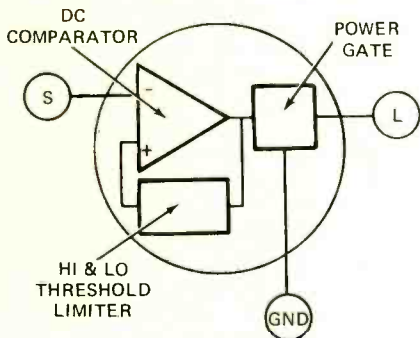

FIG. 3—MISER FUNCTIONAL block diagram.

comparator, high and low threshold voltage limiters, and a power gate capable of furnishing output currents of up to 50 mA. In most applications, the device is used with an external capacitor connected between its source (S) and ground (G) terminals; the load, be it a LED, loudspeaker voice coil, relay, or transformer primary, is connected between the load (L) and source (S) terminals. Only one version is currently available, the LP1000, supplied in a standard 3-lead metal TO-18 package.

In operation, the capacitor between the source and ground terminals is charged slowly by an external dc power source. During the charge period, the capacitor's instantaneous voltage is constantly compared to an internal threshold voltage. At the same time, the

dc-comparator holds the power gate in a high-resistance (non-conducting) state, supplying a peak threshold voltage to its own non-inverting input. As the capacitor's charge voltage reaches the peak threshold, the dc-comparator switches suddenly, biasing the power gate to a low-resistance state and, at the same time, changing the voltage at its own non-inverting input to a lower "valley" threshold. With the power gate conducting, the capacitor discharges through the external load until its instantaneous voltage drops to the new valley threshold, whereupon the dc comparator reverses its mode, turning the power gate off and returning to its original peak threshold voltage, permitting the entire cycle to repeat.

When a low resistance is connected between the source (S) and load (L) electrodes, the combination of MISER and load have an overall characteristic

which is generally similar to that of a Unijunction transistor (UJT), but at considerably lower voltage values. As with a UJT, there is the customary positive resistance slope, peak point, negative resistance slope, valley, and upward positive slope in the combination's performance curve.

Several of the MISER's interesting circuit applications are shown in Fig. 4—a LED flasher at (a), tone generator at (b), and low power dc/dc inverter at (c). In each, the MISER is type LP1000, the power source B1, a 3-volt battery, and the resistors half-watt units.

With the parts values given, the LED flasher, Fig. 4-a, delivers a single flash every few seconds. The total battery drain is less than 200 μ W. Almost any standard LED may be used, including Monsanto's popular MV50. If desired, the flashing rate may be raised, but at the expense of increased power drain. Simply reduce the value of series resistor R1 or raise the supply voltage. If B1 is replaced with a photovoltaic cell (such as International Rectifier's type S7M) and R1's value reduced to 5,000 ohms, the circuit operates as a light-powered light.

You can use the tone generator circuit illustrated in Fig. 4-b as either a low power code-practice oscillator or as a metronome, simply by changing C1's value. A high-impedance loudspeaker (20-ohm voice coil) is preferred for best performance. If used as a code-practice oscillator, C1's value may be from 0.05 to 0.5 μ F, while up to 100 μ F, or more, is needed for metronome rates.

In laboratory tests, the dc/dc inverter circuit shown in Fig. 4-c has supplied as much as 90 volts at microwatt levels when powered by a small 3-volt battery. Step-up transformer T1 is chosen for the output voltage needed, while D1 is a standard rectifier diode and C2 a suitable filter capacitor.

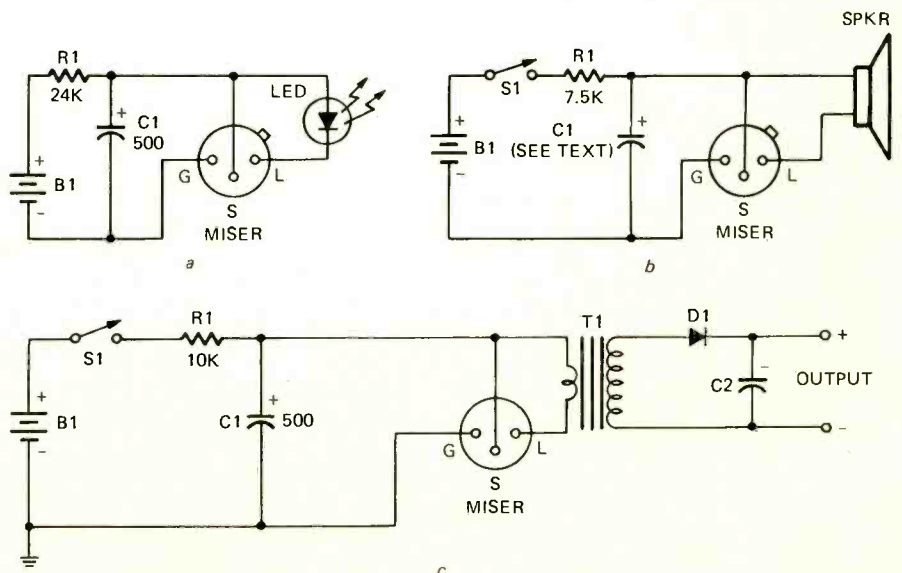

FIG. 4—TYPICAL MISER APPLICATIONS a—LED flasher; b—Tone generator or code practice oscillator; c—power inverter.

Commercially, the MISER may be used in telemetry, biomedical, communications, alarm, and automotive applications.

Device/product news

Designated type TIS125, a new npn planar transistor designed for use as a common-base amplifier in TV vhf rf applications has been introduced by Texas Instruments, Inc. (P.O. Box 5012, M/S 308, Dallas, Tex. 75222). Illustrated in Fig. 5, the TIS125 features a high power

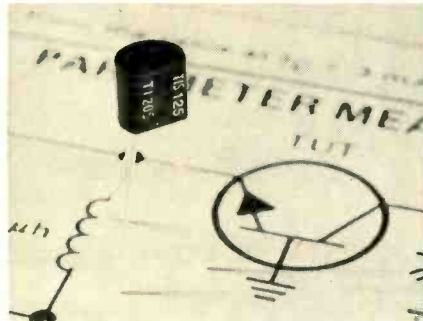

FIG. 5—TI's NEW TIS125 VHF transistor.

gain of 19 dB and a noise figure of only 3.5 dB at 200 MHz. Offered in a TO-18 pin-circle plastic package, the new unit has a low feedback capacitance of 0.3 pF maximum.

Good news from RCA's Solid State Division (Route 202, Somerville, N.J. 08876)—general base price reductions on its entire line of commercial COS/MOS integrated circuits! The new base prices apply to more than 180 standard types, including dual in-line plastic, dual in-line ceramic, flatpack and chip configurations. Price reductions average 25 percent for plastic packages, 20 percent for dual in-line and flatpack ceramic types, and a whopping 50 percent for chips.

RCA also has announced a variety of exciting new devices, including a high-current array, two new vhf/uhf transistors, a high-power switching transistor, a hybrid dual Darlington amplifier, heavy-duty triacs, and three new COS/MOS IC's.

Illustrated in Fig. 6, the new high-

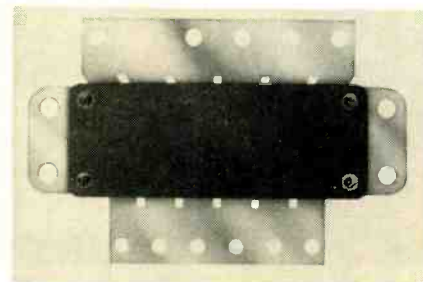

FIG. 6—RCA's TA8624 300-ampere array.

current device, type TA8624, consists of an array of six 50-ampere, home-taxialbase silicon npn transistors mounted in a compact plastic package

with a common collector connection to the mounting flange. External leads attached to either side of the package provide one common lead for six transistor bases and another for the six emitters, but the external leads can be sheared apart to separate individual base or emitter leads to form multi-parallel or single-circuit combinations; if desired, external crossover links may be added to form single- or dual-Darlington configurations. With the six transistors connected in parallel, the TA8624 has a switching capability of 300 amperes and a dissipation of 1000 watts. It can be used in such applications as dc motor controls, converters, inverters, low-frequency high-power amplifiers, and switching, series, and shunt regulators.

Designed for Class C vhf/uhf applications, RCA's new high frequency transistors are silicon npn overlay devices. Designated types 40964 and 40965, the units feature high power gain: 6 dB minimum tripling up to a frequency of 470 MHz for the 40964, and 7 dB min. at 470 MHz for the 40965. Both units are intended for use in mobile and portable transmitters in which intermediate power output is required at low supply voltages. They are supplied in JEDEC TO-39 hermetic packages.

Identified as type 2N6354, RCA's new switching device is a 120-volt, 10-ampere silicon npn transistor intended for such applications as switching-control amplifiers operated from 48-volt power supplies, power gates, switching regulators, dc/dc converters, and power oscillators. It is furnished in the popular TO-3 package, and features an exceptionally fast switching time.

Supplied in a compact 14-lead dual in-line package, as shown in Fig. 7,

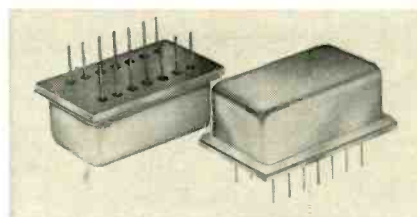

FIG. 7—RCA's TA8590 dual Darlington.

RCA's new power hybrid device consists of two Darlington amplifiers, each of which can deliver 5 amperes with a current gain of 500, or 3 amperes with a current gain of 600. The amplifiers include integral diodes for load-current commutation and, therefore, are suitable for driving inductive loads. Typical applications for the new hybrid, type TA8590, are hammer driver, solenoid driver, stepper-motor driver, and regulator service.

Intended for the control of ac loads in applications such as heating controls, motor controls, arc-welding equipment,

light dimmers, power switching systems, and in air conditioning and photocopying equipment, RCA's new triacs are rated at 40 amperes, 800 volts. Designated types 40925, 40926, and 40927, the devices are supplied in press-fit, stud, and isolated-stud packages, respectively.

RCA's new COS/MOS devices are the CD4048A, CD4057A, and CD4058A. Of these, the CD4048A is an expandable 8-input multifunction gate featuring medium power TTL drive capability, three-state outputs, low-power dissipation, high noise immunity, and good temperature stability. Three binary control inputs select 1-of-8 output functions of eight input variables. The eight output functions are OR, NOR, AND, NAND, OR/AND, OR/NAND, AND/OR, and AND/NOR. Through the use of multiplexing techniques it is possible to obtain all eight functions during a given clock time. With an "expand" input permitting cascade operation to obtain functions of 16, 24, or more variables, the CD4048A is supplied in a 16-lead dual in-line ceramic package.

The CD4057A is a flexible arithmetic array for use in LSI computers. It provides 4-bit arithmetic operations, time sharing of data terminals, and full functional decoding for all control lines. The device, furnished in a 28-lead dual in-line ceramic package, can be used in parallel arithmetic units, process controllers, remote data sets, and graphic display terminals.

Finally, the CD4058A is an MSI 8-stage fully static bidirectional shift register having parallel inputs and outputs as well as serial JK inputs. Intended for applications in code converters, up/down Johnson or ring counters, pseudo-random code generators (sequence generators), sample-and-hold registers (storage counting and display), and frequency and phase comparators, the CD4058A is available in a 24-lead dual in-line ceramic package.

Silicon General, Inc. (7382 Bolsa Ave., Westminster, Calif. 92683) has introduced an upgraded industrial version of its SG1501 dual-tracking voltage regulator. Identified as type SG4501, the new device will accept inputs of up to ± 30 volts, supplying ± 15 volts within $\pm 5\%$. Output voltage balance is within 2% and line and load regulation to 0.1%. The device is offered in both TO-100 10-lead metal cans and 14-pin dual in-line plastic packages. Its specified temperature range is 0°C to 70°C , and it has a maximum load current rating of 100 mA. The device alone can power up to 25 op amps. External transistors can extend load currents to above 2 amperes.

That concludes our look at solid state for this month, my friends . . . have a happy Thanksgiving and *don't eat the whoooole thing!* **R-E**



FIG. 1—TRANSISTOR-DIODE CURVE TRACER plugged directly into a scope. The output of this tracer can be displayed on any general-purpose scope.

Using a Solid State Curve Tracer

Many important time-saving tests can be made using a scope-curve tracer combination. Here are some tests you will want to try

by **MANNIE HOROWITZ**

THE TV OR HI-FI SERVICE TECHNICIAN uses a curve tracer to check the quality of semiconductors when they are wired in the circuit or as individual components. The hobbyist uses the instrument to select devices sold in a bulk package that he may have purchased at some "bargain" counter. The engineer uses a curve tracer to note and check characteristics of transistors and diodes when he designs them into equipment. Test and quality control technicians use curve tracers to evaluate the grade and type of device supplied by a vendor.

It is not presumptuous to state that a curve tracer is so versatile, that it serves some function to everyone involved directly in modern electronics. It may be used in a different manner by each individual, but the applications overlap.

Some skeptic might stop here and say, "I can do anything with my transistor tester that can be done with a curve tracer." While it is true that there are excellent transistor testers on the market, they will measure only a limited number of characteristics of some devices, and these only at a specific collector current or voltage level. Using a transistor tester, will in many cases, enable you to separate good devices from bad ones. Yet you can know much more about a device with but one glance at the crt of a curve tracer.

It is easier to perform the tests and measurements on the curve tracer if your scope uses direct coupling (no input or coupling capacitors in the amplifier circuits) in both the vertical and

horizontal amplifier chains. A typical arrangement of scope and curve tracer is shown in Fig. 1.

Transistor curves

The collector characteristics of a transistor can be displayed on the screen of a curve tracer. Briefly, the collector current flowing through a bipolar transistor is dependent upon two factors—the collector to emitter voltage and the base current. The traces on the screen of a curve tracer display this information. Much can be learned about the transistor from this display. A typical set of curves for an npn transistor is in Fig. 2. The npn transistor character-

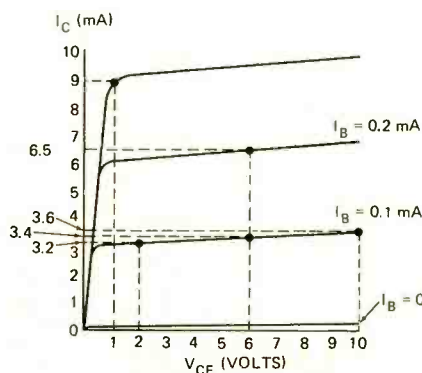

FIG. 2—TYPICAL NPN collector display and construction to determine characteristics of bipolar device.

istics are very similar—only the polarity of the voltages and currents are reversed.

Each relatively horizontal line describes how the collector current, I_C , varies with the collector-to-emitter voltage, V_{CE} . The different horizontal lines define this relationship for the various

values of base current. For example, draw a vertical line from the 6-volt point on the V_{CE} axis up to the $I_B = 0.2$ mA curve, and a horizontal line from the intersection to the I_C axis. It crosses the I_C axis at 6.5 mA. For this particular transistor, when there is 6 volts between the collector and emitter, and 0.2 mA flows into the base, the collector current is 6.5 mA.

The construction may be repeated to determine the collector current at any point on the characteristic curves. You can determine bias requirements from the display on the crt and make the necessary calculations to establish the desired idling current for the particular transistor under test.

Beta can be determined from the curves. Although it is not drawn as such, the curves do not have to be evenly spaced and the horizontal lines are not always parallel to each other. Because of this, beta will vary with I_C and V_{CE} .

Beta is the short-circuit current gain of the transistor. As you recall, two types of beta are encountered—the dc and the ac. Dc beta (β_{dc}) is the ratio of collector current flowing to the base current causing this collector current, at a specific collector-to-emitter voltage. In the figure, at $V_{CE} = 6$ volts, there is 6.5 mA of collector current when the base current is 0.2 mA. β_{dc} is 6.5 mA/0.2 mA = 32.5.

When ac signal is applied to the base of a transistor, it forces the base current to vary with the size of the input. In turn, the collector current will vary with the base current. The ac beta, β_{ac} , is the ratio of these two variations at specific collector to emitter voltages. As an example, let us assume that the signal causes the base current to change

from 0.1 mA to 0.2 mA and that V_{CE} is 6 volts. The collector current will, in turn, swing from 3.4 mA to 6.5 mA. B_{ac} is $(6.5 \text{ mA} - 3.4 \text{ mA}) / (0.2 \text{ mA} - 0.1 \text{ mA}) = 31$.

Alpha is the ratio of the collector current to the emitter current. It is used primarily when dealing with common-base circuits. The ac alpha, α_{ac} , and dc alpha, α_{dc} , can both be calculated from the respective betas using the equation

$$\alpha = \frac{\beta}{\beta + 1}$$

Another important characteristic of the transistor is the saturation voltage. At the extreme left of the display in Fig. 2, note the curve at low collector voltages. The relatively vertical curve is inclined at a slight angle. The transistor cannot operate to the left of the vertical line. At the maximum collector current of interest to you, draw a horizontal line from the vertical axis to the highest base current curve. Next draw a vertical line from the point of intersection to the V_{CE} axis. The voltage on the V_{CE} axis is a good approximation to the saturation voltage of the transistor.

From Ohm's law, resistance of any device is a voltage divided by a current. The ac collector resistance, r_a , is the ratio of the peak-to-peak voltage to the peak-to-peak current. The ratio is the slope of a particular display. For the transistor, the ac resistance varies with the base and collector currents. On the $I_B = 0.1 \text{ mA}$ curve, the collector resistance around the $I_C = 3.4 \text{ mA}$ point is $(10 \text{ volts} - 2 \text{ volts}) / (3.6 \text{ mA} - 3.2 \text{ mA}) = 20,000 \text{ ohms}$. This resistance is valid for the common emitter circuit. For the common base mode of operation, the collector resistance is approximated by beta multiplied by r_a .

The ac collector resistance of the vertical portion of the characteristic is radically different from the rest of the curve. It has been assigned the special name of saturation resistance. Ideally, it should be zero ohms so as not to limit the minimum value of collector voltage. In the figure, it is 1 volt/9 mA, or 111 ohms.

Leakage current and breakdown voltage are important characteristics of the transistor. Although they can be estimated from displays similar to those in Fig. 2, they are diode characteristics and can be determined by testing the transistor as a diode.

FET curves are similar in form to those of the bipolar transistor, except that while the current steps are fed to the base of the latter, voltage steps are impressed between the gate and source of the FET. A typical set of n-channel curves are shown in Fig. 3.

The I_{DSS} is the current flowing when the gate-to-source voltage, V_{GS} , is zero. V_P is the pinch-off voltage and is

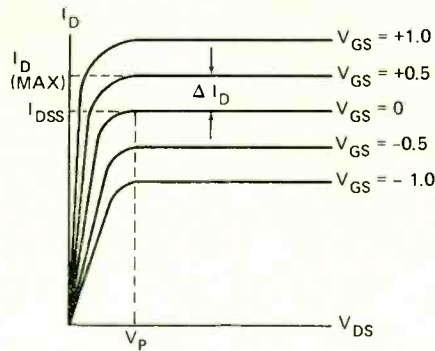

FIG. 3—TYPICAL N-CHANNEL DISPLAY and construction to determine characteristics from the display.

equal to the V_{DS} (drain-to-source voltage) at the point where the $V_{GS} = 0$ curve becomes horizontal. The zero gate voltage transconductance, g_{m0} , is approximately equal to the ratio of the difference in drain current, ΔI_D , to the difference in gate voltage, ΔV_{GS} , causing the change in drain current. In the drawing, the two V_{GS} 's are chosen at 0 and +0.5 volts. To avoid misleading answers, do not choose values of V_{GS} greater than 0.5 volts for the calculation.

For p-channel devices, only the polarity of the voltages and currents are changed. In either case, the transistor is treated as a diode to test for breakdown voltage and leakage current, I_{GSS} .

Diode breakdown curves

As you know, diodes conduct readily when a voltage is applied making the anode positive with respect to the cathode. Should the voltage be applied in the opposite direction, only a small leakage current, I_L , will flow. The current will be large when the reverse voltage is increased beyond the breakdown voltage, V_B , of the diode. A curve showing this is drawn in Fig. 4.

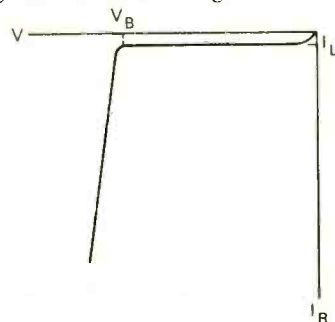

FIG. 4—REVERSE BREAKDOWN CURVE of solid-state rectifier.

Much can be learned from the curve. The diode breakdown voltage is at V_B , the voltage that causes the curve to turn from the horizontal. (This is also the regulating or rated voltage of a zener diode.) The leakage current is I_L , the distance in microamperes from the zero axis to the essentially horizontal portion of the curve at the breakdown voltage.

An extremely important character-

istic can only be seen on a curve tracer. Diodes which can best withstand transient voltage pulses (and these pulses can be extremely high), exhibit low resistance in the breakdown region. It is desirable that the vertical portion of the display be as near vertical as possible.

A good diode will be capable of dissipating as much power in the reverse direction as it is permitted to dissipate in the forward direction. As a rule of thumb, $I_R(\text{max}) = 0.7I_F/V_B$, where I_F is the forward current rating of the diode. When making tests, limit the curve tracer so that the current through the diode will not exceed the calculated $I_R(\text{max})$. The diode should, however, be capable of conducting this current.

A bad junction can only be seen on a curve tracer. The V_B voltage should be stable and not jump, however minutely, from one value to another. Any jumping indicates a poor diode that should be disposed of.

Leakage current and breakdown voltages of a transistor can be determined using diode measuring techniques.

For the bipolar transistor, I_{CBO} is the reverse current that will flow between the base and collector when the emitter lead is left disconnected. The npn device can be checked by connecting the base to the anode terminal of the diode jacks and the collector to the cathode terminal. The leakage current at any particular voltage is I_{CBO} . If you increase the voltage up to V_B , you can find the BV_{CBO} or collector-to-base breakdown voltage of the transistor.

To determine the I_{CBO} of the npn transistor, the base rather than the emitter is left open. The collector remains connected to the terminal where you would ordinarily connect the cathode of a diode, and the emitter is connected to the anode terminal. Leakage and breakdown voltage, BV_{CEO} , are measured as before.

In each case, the pnp transistor is measured by reversing the connections indicated for the npn device, on the curve tracer.

The I_{GSS} or leakage of an n-channel JFET is measured by connecting the gate to the anode terminal on the instrument and the remaining two leads to the cathode terminal. The leakage and gate-to-source breakdown voltage are measured in the same manner as the equivalent factors of the bipolar devices. The drain-to-source breakdown voltage can be checked on the curve tracer by connecting the drain to the cathode terminal and gate and source to the anode terminal. Increase the voltage until V_B is reached. Of course, the connections must be reversed should a p-channel JFET be tested.

Diode breakdown measurements also apply to the SCR. Just connect the

(continued on page 68)

RCA Institutes Home Training may be

your best investment for a rewarding career in electronics

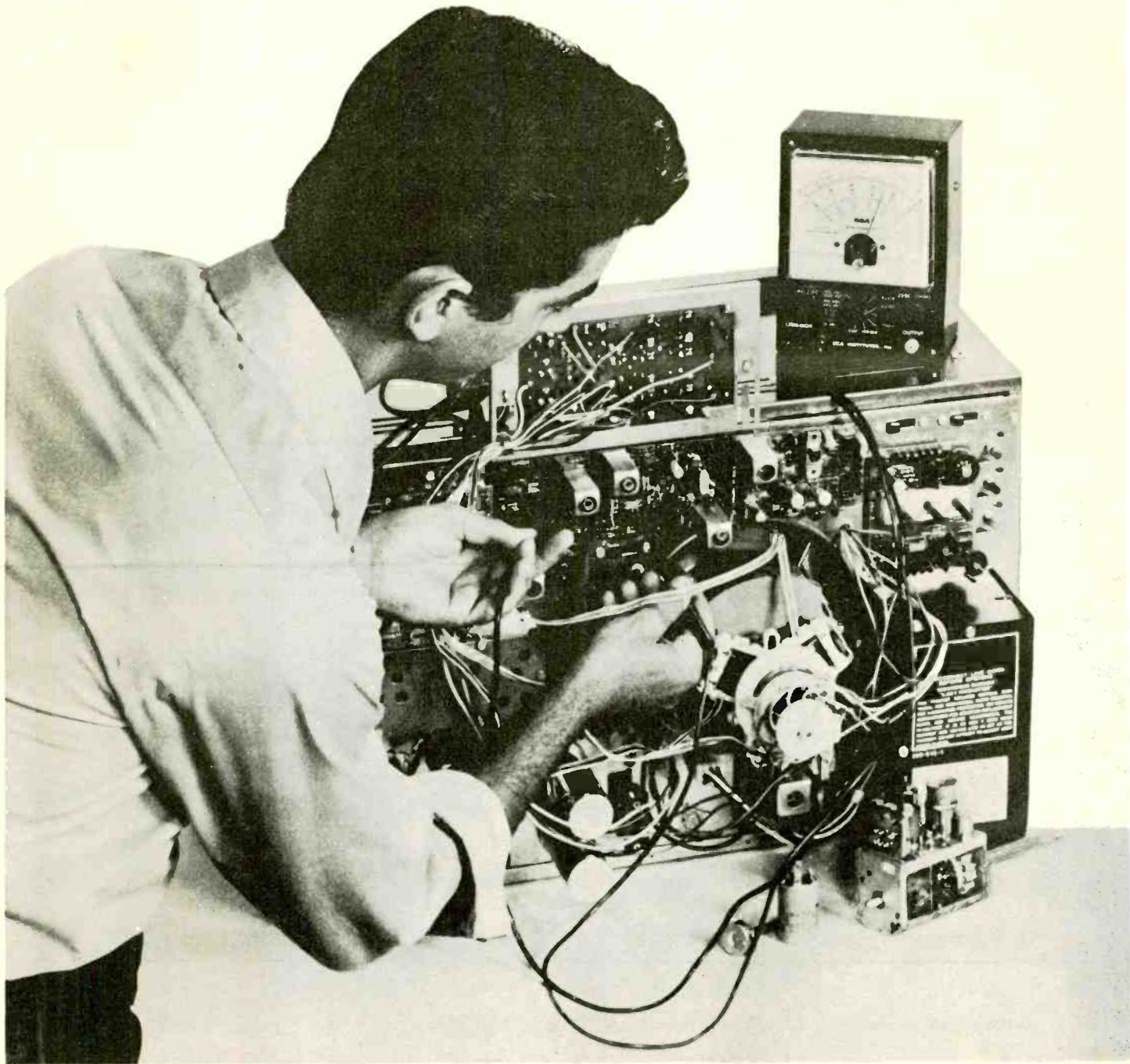

1 LEADER IN ELECTRONICS TRAINING

For over half a century, RCA Institutes, Inc., a subsidiary of RCA, has been a leader in resident school technical training in electronics. For many years, it has offered home study training in electronics.

2 RCA AUTOTEXT TEACHES ELECTRONICS RAPIDLY, EASILY

Beginner or refresher, AUTOTEXT, RCA Institutes' own method of programmed Home Training will help you learn electronics rapidly, easily.

3 WIDE CHOICE OF CAREER PROGRAMS

Start today preparing for an electronics career. On the attached card is a list of "Career Programs," each of which starts with the amazing AUTOTEXT method of programmed instruction. Look the list over, pick the one best suited to you and check it off on the card.

4 SPECIALIZED ADVANCED TRAINING

For those already working in electronics or with previous training, RCA Institutes offers advanced courses. You can start on a higher level without wasting time on work you already know.

5 PERSONAL SUPERVISION THROUGHOUT

All during your program of home study, your exams are reviewed and your questions are answered by RCA Institutes instructors who become per-

sonally involved in your efforts and help you over any "rough spots" that may develop.

6 HANDS-ON TRAINING

To give practical application to your studies, a variety of valuable kits are included in many programs. In RCA's Master TV/Radio Servicing Program, you will actually build and keep an all solid-state black and white TV set, and a color TV set. You also construct an oscilloscope which is yours to keep and use on the job.

7 FCC LICENSE TRAINING - MONEY BACK AGREEMENT

Take RCA's Communications Career Program - or enter with advanced standing and prepare immediately for your 1st, 2nd, or 3rd class FCC Radio Telephone License examinations. RCA Institutes money-back agreement assures you of your money back if you take, and fail to pass, the FCC examination taken within 6 months after completing the course.

8 CONVENIENT PAYMENT PLANS

You get a selection of tuition plans. And, we are an eligible institution under the Federally Insured Student Loan Program.

9 RCA INSTITUTES IS FULLY ACCREDITED

RCA Institutes is licensed by N.Y. State and is accredited by the Accrediting Commission of the National Home Study Council. Its courses of study, faculty and instructional facili-

ties are approved by the State Education Department. In addition, all RCA Institutes courses and programs require the approval of the RCA Institutes Board of Technical Advisers who represent various technical, research and educational activities of RCA Corporation.

Approved by N.Y. State Education Dept. for the training of veterans.

SEND ATTACHED POSTAGE PAID CARD TODAY! FREE DESCRIPTIVE BOOK YOURS WITHOUT OBLIGATION!

If reply card is detached, send this coupon

RCA INSTITUTES, INC.
DEPT. 758-211-0
320 W. 31 ST.
NEW YORK, N.Y. 10001

Please send me FREE illustrated career catalog. I understand that I am under no obligation.

Name _____

Address _____

City _____

State _____ Zip _____

Age _____

Veterans: Check here

RCA



In the Master TV/Radio Servicing Program, you build and keep the all solid-state black and white TV set, the color TV set, the oscilloscope and the multi-meter shown above.

SOLID-STATE CURVE TRACER

(continued from page 63)

gate on the device to the cathode on the device through a 1000-ohm resistor. Then check the anode-to-cathode breakdown voltage in both directions by simply reversing the connections of the SCR to the curve tracer.

Forward diode characteristic

All diodes have a distinct relationship between the applied forward voltage and the forward current. These curves tell much about the particular rectifier or diode. A typical curve is shown in Fig. 5.

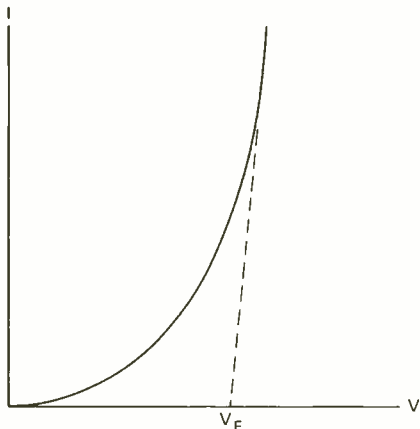

FIG. 5—FORWARD CHARACTERISTIC curve of solid state diode.

The broken line is an extension of the relatively straight portion of the diode characteristic to the voltage axis. It crosses the axis at V_F . V_F is between 0.3 and 0.5 volts for junction germanium diodes and between 0.6 and 0.8 volts for silicon devices.

The resistance of a germanium junction diode is lower than that of a point contact signal device. You can then separate the two devices by noting that the slope of a junction diode is more nearly vertical than that of a point contact diode.

The relative size of a rectifier chip determines its current carrying capacity. The capacity may be estimated from the type of curve shown in Fig. 5. At any one current level, large devices will have lower voltage drops than will power rectifiers constructed with smaller chips.

The EICO model 443 curve tracer

The EICO 443 curve tracer is shown in Fig. 6. It can produce the curves shown in Figs. 2, 3, 4 and 5, and then some, when measuring semiconductor devices. The functional panel layout allows the operator to readily use the instrument. The technician just calibrates his scope using the calibration voltages from the 443, and starts making measurements using a few of the

simple controls on the panel. A circuit designer will undoubtedly use his ingenuity to accumulate a great deal more information about a device under test than is readily available at a glance.

Using the FUNCTION switch, you can select the required one of the four groups of displays that can be generated by this instrument. Let's select and discuss one function at a time.

Transistors—signal types

Four current steps produced in this instrument feed the base of the transistor under test. The steps are synchronized to the 60 Hz power supply frequency. Thus four steps are generated during each cycle. Half-cycle pulses are fed to the horizontal input of the scope sweeping the trace four times each cycle—once on the rise and once on the decay of each half cycle. These half cycles serve two other functions as well. First they are applied across the transistor to serve as the collector supply voltages. Second, they are fed to the step generator so that the steps fed to the

base of the transistor under test, will be in time with the swept quarter cycles.

The emitter current of the transistor being tested flows through a resistor. In bipolar devices, the emitter current is just about equal to the collector current. This current, a product of the base current and beta, flows each time one of the four different steps is supplied to the base. The voltage across the resistor in

(continued on page 96)



FIG. 6—EICO MODEL 443 is a typical solid-state semiconductor curve tracer.

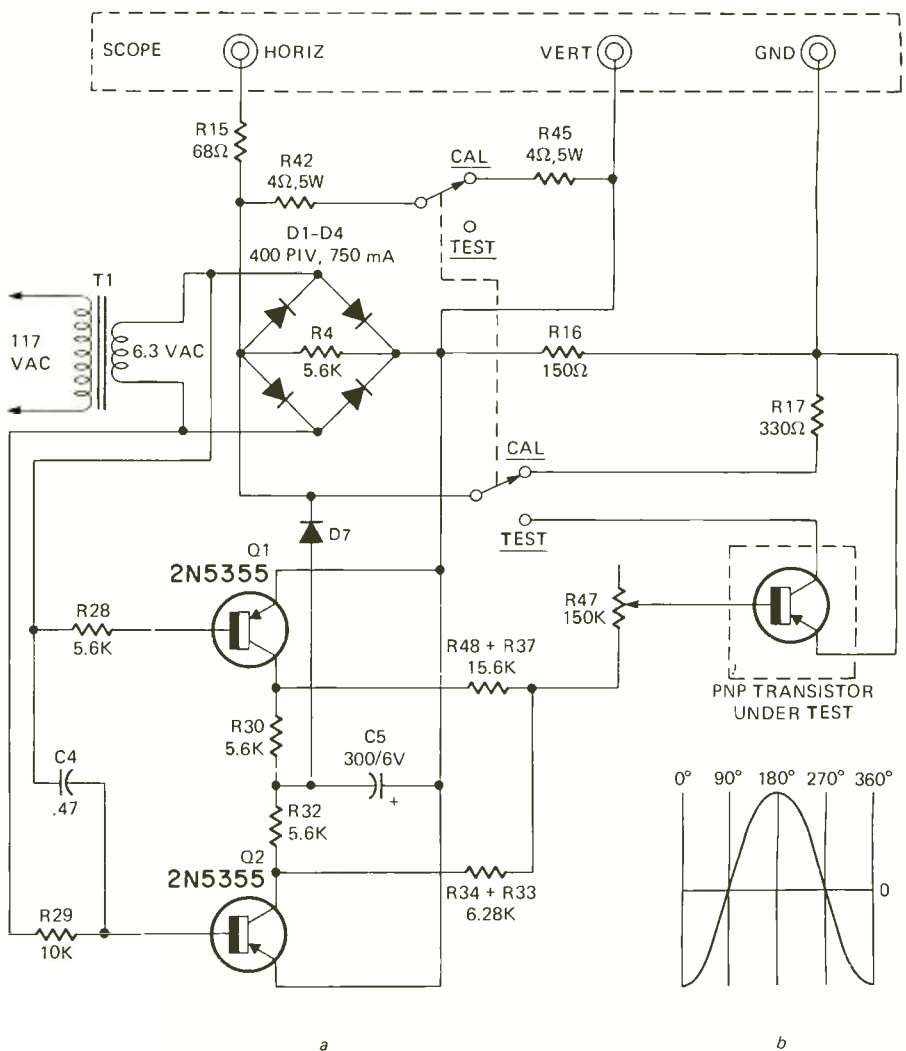

FIG. 7—CIRCUIT TO TEST SIGNAL TRANSISTORS is in (a). The negative cosine wave in (b) is used to explain the formation of the four steps fed to the base of the transistor under test.

R-E's Service Clinic

Troubleshooting— a novel approach

*Imagination aids
troubleshooting by elim-
inating the mental rut*

by JACK DARR
SERVICE EDITOR

THIS MAY SEEM ODD, IN A TECHNICAL column, but I'd like to go from technology to psychology for a while. Don't worry; it has a real, practical application. It's about the use of *imagination* in our work. The best diagnosticians have a very vivid imagination, plus a thorough knowledge of the circuit they're working on. With *both* of these, they are able to make up a list of the many, many things that could be causing the symptoms they find. After this, all they have to do is check out the list, one item at a time, to find the cause.

Try it yourself, when you get a spare moment. Get a defective set; any kind. Also get a scratch-pad. Open the set up, turn it on, and see what the main symptom is. No picture, no high voltage, no sound, etc. Write this at the top of the sheet. Now, sit there and make up a list of everything you can think of that could possibly cause it. Number each item. You might start with the one you consider the most likely and go on from there.

Now start making tests. Check off each item as you go. If your imagination is active enough, you *will* have all of the possible causes on your list. However, I think you'll be surprised to find, in many cases, that there were after all, one or more things you forgot to put down on your list.

I speak from a lot of experience. I have used this method for a long time; my shop is full of clipboards with notes on 'em. You may be a bit embarrassed the first few times. You'll find that you forgot to put down what turned out to be a very obvious cause, and this was the one. After a little practice with this method, I think you'll find your diagnostic skills sharpening up perceptibly. By back-tracking, you will be able to see where you got off the correct line.

Above all else, this will help you to develop the most valuable attribute in all diagnostic work—a *completely open mind*. The cardinal sin, of course, is the "fixed diagnosis," made on the basis of no evidence whatsoever; just what you *think* it should be. If you commit this error, you'll find yourself testing, not to find out what the real trouble is, but

solely to verify your first *opinion*. (For that's what this is; not a valid diagnosis, but just a personal opinion, until you have some hard facts and test results to back it up.)

For a good horrible example of this, you're sure that the loss of high voltage and the high current in the horizontal output tube is due to a shorted flyback. So, you change the flyback; now, you still have high current and no high voltage. Checking further, you find that the focus transformer was shorted, causing the whole trouble.

To use your imagination properly you'll have to reverse the tradition of the U.S. legal system. Everything must be considered guilty until proven innocent, by test. No matter how unlikely a certain part may seem, suspect it until you've proven definitely that it is good. When you get this result, check that one off your list and go on to the next one.

For another example, no high voltage, cathode current very low, screen voltage on output tube very low. Tube good, by replacement. Open flyback? No, by ohmmeter test. B+ supply at bottom of winding normal, so the damper is conducting. Imagination says "This tube is acting as if it had no plate voltage, but it's there on the flyback." Final result: check plate lead; insulated cap, looking good; wire not damaged. Look *inside* the plate-cap, and find that the wire has corroded and opened up. No plate voltage.

For a final example, during WW II I was servicing a B-25 bomber which was ferrying through our field. It was parked on a taxi-strip about half a mile from the tower. I pulled the SCR-522 vhf radio, took it to the shop, changed a tube, tuned it up, and called the tower. Fine. Time, 12:00 midnight. At 3:00 AM, after two trips back to the shop, and a perfect response, the radio still would not work in the aircraft.

My test instruments showed that the transmitter had ample rf output, good modulation, and everything else, but I could not get the tower. Mikes and every other part of the ship's wiring, checked. Since I had already tried cussing, I did the only thing left. I sat down

This column is for your service problems—TV, radio, audio or general and industrial electronics. We answer all questions individually by mail, free of charge, and the more interesting ones will be printed here.

If you're really stuck, write us. We'll do our best to help you. Don't forget to enclose a stamped, self-addressed envelope. Write: Service Editor, Radio-Electronics, 200 Park Ave. South, New York 10003.

on the runway and cried.

Sitting there in the cold Texas moonlight, Imagination finally came to the rescue. From where I sat, I could see the "ax-handle" vhf antenna on the bottom of the fuselage. Looking past it, I could see that the antenna, the right landing-gear strut and the tower were perfectly lined up. I said, "Imagination, shut up! That strut *couldn't* be splitting the signal. It *couldn't* be!" Imagination says "Try it. What have you got to lose except more sleep?"

I untied the tail tie-down, fastened the rope to my jeep, and dragged the tail of the aircraft about 5 feet to one side. Crawling wearily back up into the

cockpit, I picked up the mike. "Rosy Tower, this is Army 359. Radio check, please." Back came a roar "Army 359, 5 by 5! Loud and clear!" "Thank you, Rosy Tower! Army 359 over and out! Goodnight!"

The moral of this is, of course, that after you've exhausted all of the reasonable, normal alternatives, sit back and let your imagination take it from there. There must be something you haven't thought of yet. Wind it up and let it fly, and sooner or later you'll get it. If all other ways have been exhausted, try a vivid imagination. Remember, no idea is too far-fetched to be worth investigating if all else has failed. R-E

reader questions

FLOATING BLUR

I've got an odd floating blur in a Philco 19KT51 chassis. It's about 6 inches high, and floats slowly up the picture. When the blur is at the bottom of the screen, I can see video that should be at the top of the picture, and vice versa.—A.M. Philadelphia, Pa.

Whatever it is, it is a "60-Hz" pulse (only one bar visible). Suggestion; put a scope on the dc supply lines around the video stage, and look for anything like a 60-Hz ripple or hash, pulse, etc. A heater-cathode short in the video output tube will cause the same kind of symptoms. In fact, any tube in the signal-path, with a cathode resistor, and a heater-cathode short can do it. I've seen an rf amplifier tube cause similar symptoms.

WHITE FLASHES

I've got an old RCA CTC-9 color chassis on the bench. Works like a charm, with a few new tubes and a resistor or two, and realignment. But the set has an intermittent white flashing in the picture. The whole picture will go very bright, and out of focus a little, then go back to a good color picture. Long-term intermittent. I'm afraid to take it back until I find this.—L.H., Honobra, Okla.

This is caused by something that is affecting the video(Y) signal, or, you could say, the brightness level. The pix tube cathode voltages are going negative (which makes the picture tube go to higher brightness) then falling back, to normal.

The most likely cause for this is an intermittently-leaky or shorted 12BY7 last video output tube. Try a new one here. While you're there, clean the socket contacts and check all of the PC board conductors for breaks.

VERTICAL BLINK

I've got an Airline color TV in for service. The raster will collapse to a very thin line, then slowly fill up again. Action is pretty fast. This is a GEM-17148B chassis, and I can't find a listing in the Sams file. The vertical tube (13GF7) is OK, and the dc voltage supply is OK.—R.D., Vinita, Okla.

For a schematic, check the "Sharp CN-52T", Sams Set 1076-2. This is practically the same, especially in the vertical circuit. (Airline made by Sharp, in this one)

Check the cathode voltage on the vertical output; pin 3 of the 13GF7. If it is jumping up and down, turn it off, and check for continuity to ground. Should read 1470 ohms; a 470-ohm resistor on

CHANNELLOCK

Gives You More In Hand Tools Including

SNIPS THAT CUT EVERYTHING, EASIER AS BUTTER ON THE FOURTH OF JULY

You don't need the grip of a gorilla to cut "tough stuff" such as sheet metal, leather, gaskets, plastics, screening, rubber, roofing materials . . . not with a CHANNELLOCK snip in your hand. With little more effort than you'd use on paper shears, you'll ease these perfectly mated, precision ground cutting edges through the "tough stuff" . . . smoothly, accurately, positively. And happy day! No more blisters . . . the grips are cushion coated with durable dipped plastic. Like all our hand tools, CHANNELLOCK snips are drop forged of highest grade tool steel, scientifically heat treated . . . your assurance that they'll be tough, dependable helpers for years to come.

COMPLETE CATALOG INFORMATION is yours for the asking.

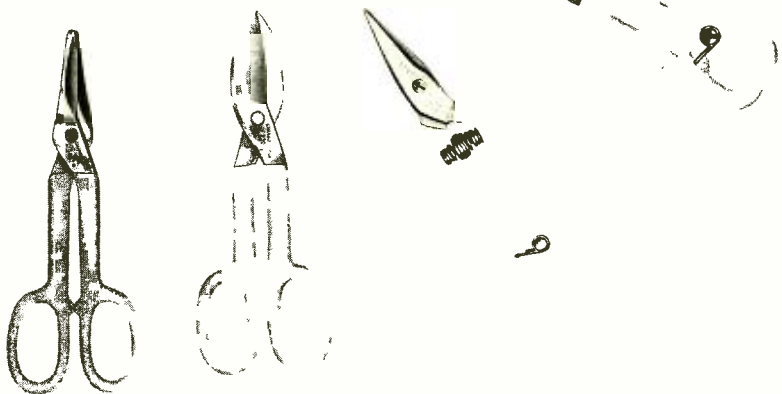

TOOLS BY
CHAN NEL LOCK
MEADVILLE, PA. 16335

Circle 15 on reader service card

NEW DYNA-KIT DIGITAL MULTIMETER - ONLY \$199.

MINI-LINE SALE Fully Assembled Instruments



Model 912 PRESET COUNTER
~~\$630.00~~ \$79.00



Model 913 DUAL PRESET COUNTER
~~\$725.00~~ \$89.00

Both models operate in either a "Limit Mode" or "Recycle Mode" with a frequency range (selectable by internal switch) of either 0 to 100 Hz or 0 to 10 KHz. In the "Limit Mode" "output" is held at the preset number until reset manually, while continuing to count; and in the "Recycle Mode" the counters hold the "pulse relay output" at the preset number, then reset to "0" and automatically resume counting. The Model 913 is equipped with a second bank of 5 preset switches, a second control switch so that there is independent control for each switch bank. Both units completely compatible with the other CMC compact instruments, but come in 16.8" widths for standard rack mounting.



Model 915
~~\$555.00~~ \$99.00

Model 915 TIME INTERVAL METER

A low-cost instrument that features a 1-MHz temperature-compensated crystal oscillator... triggers on positive or negative going pulses... can be operated in either a 1 μ s or 1 ms mode, with a range from 0 to 99,999. Starts on the A-input and stops on the B-input, and permits reset even during the measurement operation. 915 measures 4" x 5" x 8 1/2" Wt. 3 1/2 lb.



Model 925
~~\$340.00~~ \$79.00

Model 925 ELECTRONIC TOTALIZER

Frequency range, from dc to 1-MHz, or dc to 100 Hz (internally switch selectable) with totalizing count from 0 to 99,999. Trigger level is automatic, and a pushbutton switch on the front panel resets the count to "0". Same dimensions as the 915 and fully compatible with the other compact instruments in this line.

Now, for the first time, the popular Dynasciences Model DM330 is available in kit form for half the price of the fully assembled instrument. Complete with assembly instructions, this instrument can be put together by any competent technician in a few days.

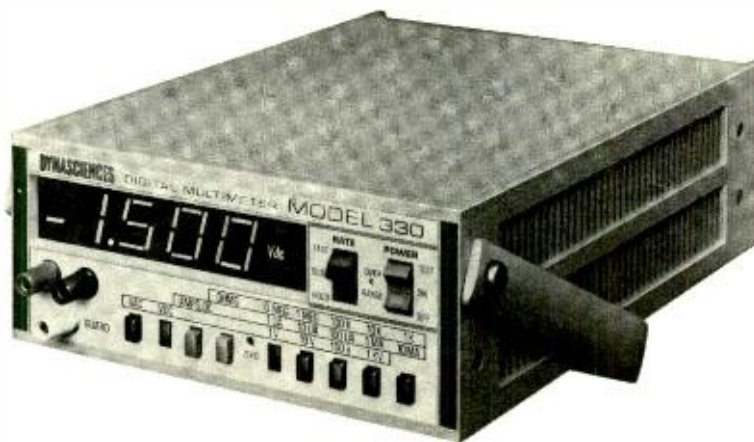

DM 330 DYNA-KIT IS LEAD ITEM IN BIG DISCOUNT SALE!

For our recent Surplus Inventory Sale, we slashed the price of our DM 330 from \$399 to \$299. Now with our DYNA-KIT sale we have slashed the DM 330 to a new low of \$199. Take advantage of this lead item in our big, new, Inventory Sale. Just check the specs below and order yours now while we still have some left.

Special Features

1. FULL MULTIMETER CAPABILITY. DC volts, AC volts, DC current, K Ω measurements, all built in.
2. HIGH ACCURACY. $\pm 1.1\%$ ± 1 digit on DC volts, K Ω and current functions. $\pm 1\%$ ± 1 digit on AC volts.
3. 100 dB COMMON MODE REJECTION.
4. HIGH SPEED READINGS. Up to 10 readings/sec.
5. BRILLIANT IN-LINE DISPLAY. 25,000 hour life for numerals, decimals and function displays.
6. PORTABILITY. Light weight, 1/2 rack size.
7. UNIQUE CURRENT MEASUREMENT CIRCUIT. 10 mV maximum voltage drop.
8. LOW, LOW, COST.

Be sure to check the great bargains in our Mini-Line, too. All Mini-Line prices are for fully assembled instruments.

Mail this coupon now. or call us direct: (213) 341-0800!

ORDER COUPON

DYNASCIENCES

9601 CANOGA AVENUE, CHATSWORTH, CALIFORNIA 91311
TELEPHONE (213) 341-0800 • TWX 910-494-1951 • TELEX 67-3382

- Okay, I know a bargain when I see one.
Deliver (Model(s)) _____ to me ASAP.
 My Check # _____ is enclosed.
 My P.O. # _____ enclosed will follow.

Name _____ Title _____
Company Name _____
Address _____
City _____ State _____ Zip _____

the PC board near the socket, and a 1000-ohm resistor (a 2-watt film type). The last one is probably opening intermittently.

By the way; this 1000-ohm resistor is completely inaccessible unless you pull the chassis. It's in a group of similar resistors to the left and below the opening you see by taking off the bottom plate. Trace the circuit from the 13GF7 socket to the 23JS6 (horizontal output tube) socket. You'll find a thin green wire going to pin 4 (suppressor) and then going on over to the 1000-ohm resistor. Quick-repair, just clip the wire to the original resistor, and solder a 5-watt wirewound 1000-ohm resistor from the lance on the PC board (bottom of the 470-ohm resistor) to ground. There is plenty of room for this in here. Use spaghetti on the leads.

POOR HORIZONTAL SYNC

I've got a Zenith 14N22 chassis with very poor horizontal hold action. From the solder joints, it looks as if there has been some "work" done around that circuit. I've checked all of the capacitors, and so on, with no results. Where do I go from here?—F.S., Acorn, Ark.

Check the apc diodes. If they have been replaced, it could be that someone used a poor grade of diode, or that one of them is leaking. The scope photo shows you what the sawtooth will look

like when this happens. (or it did on the last one of these that I found.)

This waveform reads about 4 volts peak-to-peak, and it ought to be about 17 volts. Note the distortion: it also

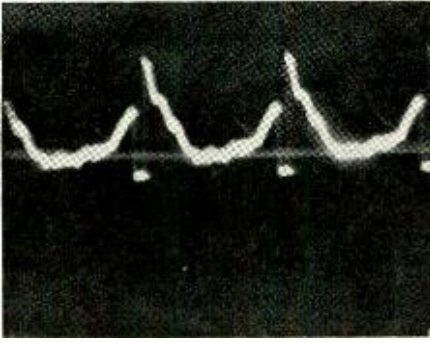

shimmered so badly that it was hard to photograph. Try a new pair of diodes, and check them for balance and reverse leakage before you put them in!

HORIZONTAL OSCILLATOR FREQUENCY PROBLEMS

In a recent Service Clinic, you had a question about a horizontal oscillator running too high. I found the same kind of trouble in a Zenith 14M23. It whined, with no picture on the screen. Tracing the B+ lead back from pin 1 on the horizontal control tube, a 6GH8, I found that C44B, an 80 µF electrolytic capacitor in the B+ supply was open. Replacing this

cured the trouble.—Gerald Oium, Towner, N.D.

Duly noted and filed! Thanks, Gerald. Found a lot of hash on the B+ when you scoped it, didn't you?

COLOR PROBLEMS?

In a practically new Motorola Quasar II TS-929 color set, I had what looked like agc problems. On weak stations I got a picture. On a strong signal the raster went out. Left small "sparkles" of light, so I knew it wasn't the high voltage. I adjusted the i.f. agc control, and now I have a good monochrome picture.

However, I have a weird color problem. When I turn the color (intensity) control up, I get big horizontal bands of over-saturated color. However, in between these are bands where the colors are locked in the right places on moving objects. I scoped the color demodulator (1C) and color amps, etc., with a color-bar signal, and I got the right patterns—jittery, but OK. All keying pulses are OK, agc and all. I think this is agc, but what?—R.G., Baltimore, Md.

Right! This is an agc problem, but one of adjustment. The i.f. agc control on these sets is pretty sharp, and hard to hit, unless you're very careful. This condition can be caused by the agc control being set too far toward the "blackout" end. Move the control back to a "white-

(continued on page 78)

INTERNATIONAL Frequency meter FM-2400CH



The FM-2400CH provides an accurate frequency standard for testing and adjustment of mobile transmitters and receivers at predetermined frequencies.

The FM-2400CH with its extended range covers 25 to 1000 MHz. The frequencies can be those of the radio frequency channels of operation and/or the intermediate frequencies of the receiver between 5 MHz and 40 MHz.

Frequency Stability: $\pm .0005\%$ from $+50^\circ$ to $+104^\circ\text{F}$.

Frequency stability with built-in thermometer and temperature corrected charts: $\pm .00025\%$ from $+25^\circ$ to $+125^\circ$ (.000125% special 450 MHz crystals available).

Self-contained in small portable case. Complete solid state circuitry. Rechargeable batteries.

WRITE FOR CATALOG!

- Tests Predetermined Frequencies 25 to 1000 MHz
- Extended Range Covers 950 MHz Band
- Pin Diode Attenuator for Full Range Coverage as Signal Generator
- Measures FM Deviation



FM-2400CH	
(meter only).....	\$595.00
RF crystals (with temperature correction)	24.00 ea.
RF crystals (less temperature correction)	18.00 ea.
IF crystals.....	catalog price



CRYSTAL MFG. CO., INC.
10 NO LEE • OKLA. CITY, OKLA. 73102

Universal tap simplifies MATV design

by Bert Wolf

Manager Jerrold DSD/ECS Division

Until now, MATV system design has been somewhat complex. You had to calculate losses in decibels and specify a fixed tap-off isolation value at each receiver location.

The new Jerrold OMNI-TAPS have changed all this. OMNI-TAPS are universal. That is, *any* OMNI-TAP can be used *anywhere* in *any* MATV system. The secret is adjustable isolation, which you can vary simply by turning a screwdriver after the system has been installed.

Aside from simplifying system design, OMNI-TAPS also reduce your inventory problems. Since OMNI-TAPS can be varied continuously over a 12 to 25 dB range, one type of OMNI-TAP replaces three types of conventional tap-offs.

Figure 1, for example, shows a typical 8 story apartment house, older school or hotel, with eight TV outlets per floor. OMNI-TAPS are used for every TV outlet. Because tap insertion loss is very low (average about 0.6 dB per tap at VHF), isolation is adjustable, and Jerrold CAC-6 cable loss is minimal. (3.2 dB/100' at VHF), your system calculations are greatly simplified. Just use a Jerrold Gibraltar 3550 amplifier, fed by a Paralog Plus antenna. A new motel or school would be similar, except that trunklines would be run horizontally.

If your particular system is smaller, reduce the number of trunklines and tapoffs, but nothing else. The 3550 is economical enough even for small systems. If the system is bigger, add trunklines and tap-offs, but nothing else. The 3550 can easily handle up to 100 OMNI-TAPS. (For systems over 100 tap-offs, use the 3661 or 3880.)

Choose the antenna as you would an ordinary home TV antenna, except that it usually pays to choose the next larger model. If signals are weak, simply add a Powermate preamplifier.

Figure 1 is a VHF-only system. But adding UHF channels is no problem. Simply use a VU-FINDER PLUS antenna instead of the PARALOG PLUS, and a 4400 82 channel amplifier in place of the 3550. No other changes are required because the OMNI-TAPS,

the splitters and the cable can handle UHF frequencies with no difficulty.

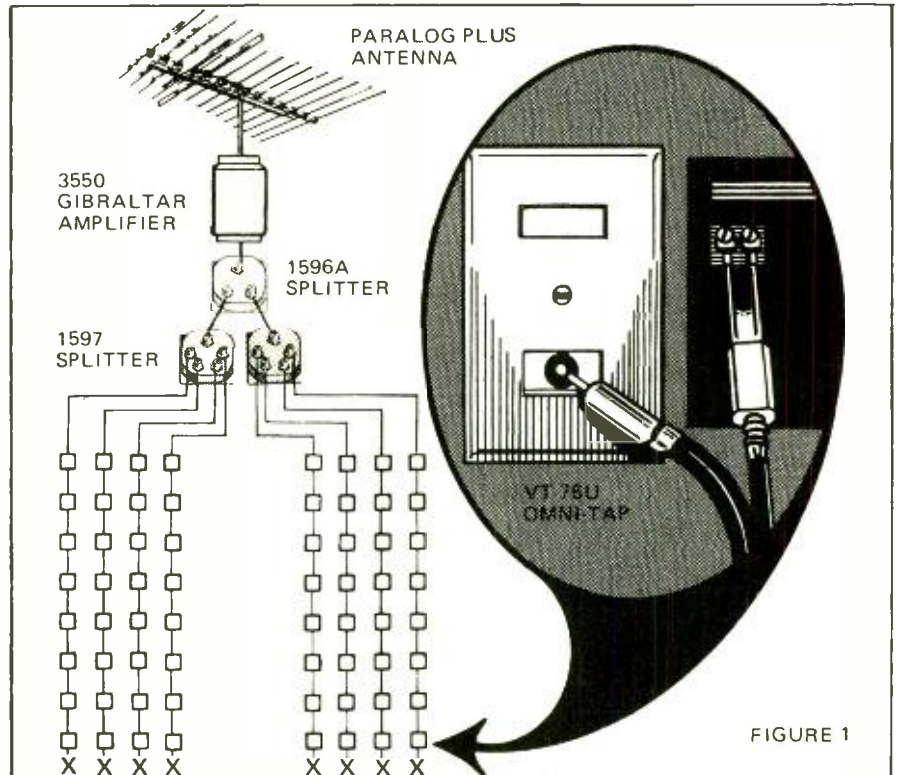

Adjusting Omni-Tap Isolation

Once the system is installed, you have to make sure it works properly. In many cases, no adjustments will be necessary. The OMNI-TAPS will work fine in the system just as you receive them.

In large systems, however, you will have to adjust the OMNI-TAPS so that they provide more isolation near the Head End amplifier than they do at the ends of the trunklines.

There are two ways to adjust OMNI-TAP isolation:

1. With a Field Strength Meter, such as the Jerrold 747. You should have a Field Strength Meter for MATV work anyhow, and this is the easiest way to adjust OMNI-TAP isolation.

Start by turning all of the OMNI-TAPS fully clockwise, for
Circle 18 on reader service card

maximum attenuation. Then, go to a tap in the middle of the trunkline and make sure you can read at least 1000 microvolts of picture carrier signal on the highest channel the system carries. If the reading is less than 1000 microvolts, turn the OMNI-TAP counterclockwise until you get 1000 microvolts. Repeat for each tap until you get to the end of the line.

2. With an Ohmmeter. Connect the Ohmmeter between the arm of the OMNI-TAP potentiometer and the center conductor of the tap output. Set the first four OMNI-TAPS in each trunkline (nearest the Head End) to 700 ohms. Set the next two OMNI-TAPS in each trunkline to 500 ohms. Then, reduce each tap-off in the line by 100 ohms until you get to the end of the line.

For help in laying out a system or solving specific system problems, contact Jerrold via your local Jerrold distributor.

Or, for more information on MATV systems, write Jerrold Electronics, P.O. Box A, Philadelphia, Pa.

New kits for every interest in



Kit AR-1214 **169⁹⁵***

(AJ-1214 Tuner & AA-1214 Amp, 89.95* each)

New Heathkit 50-watt Stereo Receiver

The new Heathkit AR-1214 AM/FM Stereo Receiver comes on with a great new look that's as practical as it is beautiful and the AR-1214 is a work of Heath audio excellence throughout. The amplifier section produces a clean 25 watts IHF, 15 watts RMS, per channel into 8 ohms. Two integrated circuits and two ceramic filters in the IF give this receiver a selectivity greater than 60 dB and superior amplifying/limiting characteristics. The phase lock multiplex demodulator gives 40 dB typical channel separation at less than 0.5% distortion. The preassembled FM tun-

ing unit provides 2 μ V sensitivity and a 2 dB capture ratio. The phono preamp section also uses integrated circuitry and has its own level controls so turntable volume can be set to coincide with tuner levels. All this in a money-saving kit project that's a pleasure from start to finish. Most circuitry mounts neatly on just three printed boards. The FM tuner is preassembled. Three evenings and just four simple alignment adjustments will have it all together. And the cabinet is included in the low price. Other features are: Black Magic panel lighting to hide the dial face when the receiver is off; flywheel tuning; stereo indicator light; headphone jack; speaker on/off button; built-in AM antenna. And there are complete tape monitor facilities so you can hear recorded material as it is committed to tape, make use of the many add-on components that use these jacks, or combine your AR-1214 with the matching AA-1214 Amp for a great sounding 4-channel system at a nice price. Stereo "separate" versions of the AR-1214 are also available: the AJ-1214 AM/FM Stereo Tuner at 89.95*; and the AA-1214 Stereo Amp at 89.95*. Both prices include cabinets. For a bold new sound in your listening room, order your Heathkit AR-1214, today. 16 lbs.

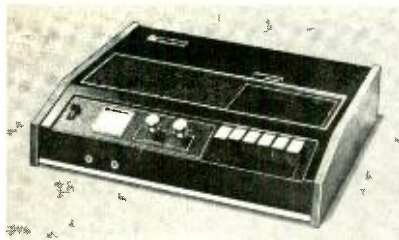

Kit AD-110

Heathkit Stereo Cassette Deck **129⁹⁵***

The AD-110 Stereo Cassette Deck offers a typical frequency response of 30-12 kHz for full fidelity reproduction of all mono and stereo cassettes, including chromium-dioxide. The built-in record bias adjustment requires no external equipment, utilizes the front-panel meter and a built-in reference. Features include precision counter, automatic motor shutoff, preassembled and aligned transport mechanism. Compatible with any quality mono or stereo system. 12 lbs.



Kit SB-313 **339⁹⁵***

New Heathkit SB-313 SWL Receiver

Covers 9 switch-selected bands between 3.5 & 21.8 MHz; receives SSB, CW, and AM with professional quality. 5 kHz AM crystal filter supplied, separate SSB & CW crystal filters optional. Solid-state circuit including 4 MOSFETs. IC crystal calibrator provides markers every 100 kHz or 25 kHz. Plug-in boards & wiring harness simplify assembly. 22 lbs.



Kit HW-7 **69⁹⁵***

New Heathkit HW-7 CW QRP Transceiver

Work the globe on "flea-power" with this 3-band QRP CW transceiver featuring VFO & provision for xtal transmit operation. Covers CW portion of 40, 20, & 15 meters. Solid-state circuit. Sensitive Synchrodyne detector. Built-in sidetone & relative power meter. Operates from optional AC power supply (14.95*) or 12V batteries. 6 lbs.

**See them all at
your local Heathkit
Electronic Center...or
send for FREE catalog**

HEATHKIT ELECTRONIC CENTERS — ARIZ.: Phoenix, 2727 W. Indian School Rd.; **CALIF.:** Anaheim, 330 E. Ball Rd.; El Cerrito, 6000 Potrero Ave.; Los Angeles, 2309 S. Flower St.; Pomona, 1555 Orange Grove Ave. N.; Redwood City, 2001 Middlefield Rd.; San Diego (La Mesa), 8363 Center Dr.; Woodland Hills, 22504 Ventura Blvd.; **COLO.:** Denver, 5940 W 38th Ave.; **CONN.:** Hartford (Avon), 395 W. Main St. (Rte. 44); **FLA.:** Miami (Hialeah), 4705 W. 16th Ave.; **GA.:** Atlanta, 5285 Roswell Rd.; **ILL.:** Chicago, 3462-66 W. Devon Ave.; Downers Grove, 224 Ogden Ave.; **IND.:** Indianapolis, 2112 E. 62nd Ave.; **KANSAS:** Kansas City (Mission), 5960 Lamar Ave.; **MD.:** Baltimore, 1713 E. Joppa Rd.; **Rockville,** 5542 Nicholson

the new free Heathkit catalog

Heathkit GR-900 25V TV...the most exciting set we've ever offered!

UHF/VHF detent power tuning heads up an impressive list of GR-900 deluxe features. Push a button and you scan either UHF or VHF channels, in either direction, with detent action locking in on the 12 VHF and any 12 preselected UHF channels. New voltage-controlled varactor UHF tuner and a newly designed VHF tuner with MOSFET contribute to better fringe-area reception and increased sensitivity. A new angular tint control for "normal" or "wide angle" color demodulation minimizes tint and flesh tone change when you switch channels or when programs change. Other features include "instant on" with override; automatic fine tuning; adjustable tone control; stereo-hi-fi audio output; automatic chroma control; adjustable video peaking; adjustable noise limiting; gated AGC; illuminated channel identification. For total armchair control, there's even an optional wireless remote control. The exclusive Heath MTX-5 ultra-rectangular bright tube measures a full 25 inches diagonal, 315 sq. in. viewing area — has a specially etched face plate to cut glare, with each color dot projected against solid black background for extra crisp-

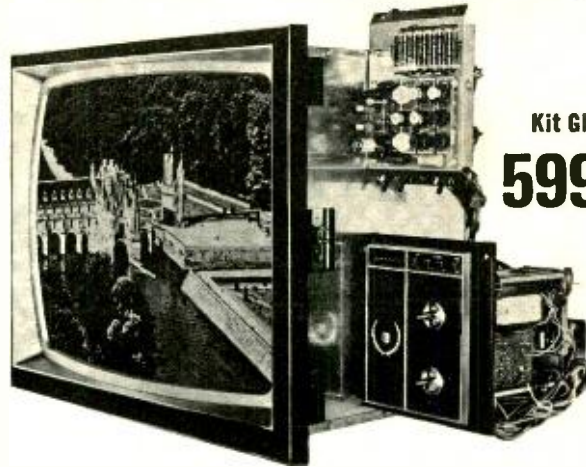

Kit GR-900
599⁹⁵*

ness. The built-in dot generator and tilt-out convergence panel are periodic adjustment aids you'll find only on Heathkit sets. And a built-in volt-ohm meter and simplified troubleshooting section in the manual permit self-servicing should the need ever arise. The new Heathkit catalog lists four beautiful cabinets for the GR-900, plus the exciting new custom wall mount that allows you to build the set into a wall. Brighten your life with the Heathkit GR-900... now! 125 lbs.



Kit IT-121 **49⁹⁵***

New Heathkit IT-121 FET Tester

Tests transistors, diodes, FETs, SCRs, triacs, unijunction transistors in or out of circuit. 5 current ranges measure leakage as low as 1 uA and collector currents as high as 1A. Gain (DC Beta), transconductance (GM) and leakage values read directly on large meter face. Special battery testing circuit gives meter indication of self-contained power supply. 6 lbs.



Kit CI-1040 **29⁹⁵***

New Heathkit CI-1040 Inductive Timing Light

Features extra bright daylight-use flash and all new triggering method. Special low-voltage inductive trigger pickup coil lets you connect light while engine is running, eliminates direct connections to spark plug, prevents interference with other test instruments connected to engine. High-impact, shock-proof plastic case. 4 lbs.



Kit GD-348
89⁹⁵*

New Heathkit Deluxe Metal Locator

Spots metal objects as small as a dime underground, searches under water up to 2 ft. deep. Unit sounds off only when metal is neared, tone gets louder as you approach. Convenient grip-mounted controls. Handle telescopes, head swivels to fold into neat flat package for carrying in optional leather carrying case with shoulder strap (6.95*). Headphones (4.50*) and battery (1.50*) are optional. Order your GD-348 today. 6 lbs.

Lane; MASS.: Boston (Wellesley), 165 Worcester St.; MICH.: Detroit, 18645 W. Eight Mile Rd. & 18149 E. Eight Mile Rd.; MINN.: Minneapolis (Hopkins), 101 Shady Oak Rd.; MO.: St. Louis, 9296 Gravois Ave.; N.J.: Fair Lawn, 35-07 Broadway (Rte. 4); N.Y.: Buffalo (Amherst), 3476 Sheridan Dr.; New York City, 35 W. 45th St.; Jericho, L.I., 15 Jericho Turnpike; Rochester, Long Ridge Plaza; OHIO: Cincinnati (Woodlawn), 10133 Springfield Pike; Cleveland, 5444 Pearl Rd.; PA.: Philadelphia, 6318 Roosevelt Blvd.; Pittsburgh, 3482 Wm. Penn Hwy.; TEXAS: Dallas, 2715 Ross Ave.; Houston, 3705 Westheimer; WASH.: Seattle, 221 Third Ave.; WIS.: Milwaukee, 5215 Fond du Lac.

HEATH COMPANY, Dept. 20-11		HEATHKIT	
Benton Harbor, Michigan, 49022		Schlumberger	
<input type="checkbox"/> Please send FREE Heathkit Catalog.			
<input type="checkbox"/> Enclosed is \$ _____, plus shipping			
Please send model(s) _____			
Name _____			
Address _____			
City _____		State _____	Zip _____
Prices & specifications subject to change without notice.			
*Mail order prices; F.O.B. factory. CL-440			

Circle 100 on reader service card



Telex headphones and headsets give you that comfortable feeling of assurance when you monitor broadcasts or communications. Signals come through loud and clear — intelligibly and reliably.

Telex professional monaural or stereo headphones incorporate audiometric-type transducers that are impervious to temperature or humidity changes and provide you with absolute performance consistency day in, day out. These sensitive dynamic transducers produce high output levels with minimum consumption of transmission power. Available in single or dual muff configuration and with noise cancelling dynamic or carbon boom microphones.

And you'll never miss a cue or program buss with a Telex Anouncers Earset®. Inconspicuous for 'on camera' work, it has practically become standard in the industry.

Or you can select a Teleset®, Twinset® or Earset® for lightweight, comfortable and inexpensive private monitoring. And for special applications in business or home, industry or institution, Telex makes a listening device to fit your requirements. Available at better sound dealers or write for free information. You'll hear more from Telex.®

PRODUCTS OF SOUND RESEARCH
TELEX®
 COMMUNICATIONS DIVISION
 9500 ALDRICH AVENUE SOUTH
 MINNEAPOLIS, MINNESOTA 55420



CANADA: DOUBLE DIAMOND ELECTRONICS, LTD., Ontario
 EUROPE: ROYAL SOUND COMPANY, INC., 409 North Main Street, Freeport, N.Y. 11520 U.S.A.

Circle 19 on reader service card

78 RADIO-ELECTRONICS • NOVEMBER 1972

READER QUESTIONS

(continued from page 72)

out." Then, very slowly, bring it back until you see a good color picture. Going just a little too far will cause this color condition, before you black out the whole picture. Get it set exactly right, and it will hold.

S-BENDING

I have a very bad case of bends in the picture, with sync instability, etc., in a GE AA chassis. I have checked all of the filter capacitors, with no results. What is causing this?—C.L.E., Malacanang, Philippines

This chassis has two main PC boards, mounted to a sheet-metal frame with self-tapping screws. If either of these boards develops a high-resistance ground connection, you'll get symptoms exactly like this.

Suggestion: loosen and retighten all of the grounding screws. If this doesn't help, then run extra grounding wires, or shield-braid, between the ground foils and the chassis. Most likely suspect, the one with the video i.f., agc and so on.

INTERMITTENT FLARE, RASTER COLLAPSE

In a Clairtone C11 color TV chassis, the picture bloomed, brightened, showed retrace lines, then faded and went out, at intervals. I replaced the 3A3, and it cleared up for about 10 minutes, then went out again. Pulled chassis, took to shop. As expected, it played for hours!—S.J., Scarborough, Ont.

(I started to answer this, then got another letter! In this, the reader said "Never overlook the too-simple and obvious things! While waiting for the thing to cut out, I pushed down on one corner of the PC board, and the raster flared and went out. So did the heater of the G-Y amplifier, the R-Y/B-Y amplifier and the X demodulator. Common ground point for these heaters is an eyelet on the corner of the PC board. Now everything is fine.)

That's what I like; self-answering questions! Thanks to Steve Jordan, Scarborough, Ontario, Canada.

HOT POWER TRANSFORMER

One of my customers replaced the EZ81 rectifier tube in his Eico HF-12 amplifier with a 6CA4. He said it played well for about an hour, then the power transformer burned out! I replaced the power transformer with an exact duplicate, but it runs hot!

I have checked the current drain, and it runs only about 60 mA instead of the 90 mA specified. Dc voltage is +360 V, as shown, but the transformer still runs very hot. What do you think?—B.A. Houston, Tex.

Power transformers are heated by

Speaker super market? Super speaker market.



In a super market, you get a big selection, low prices, nationally-advertised merchandise. Make Quam your speaker super market.

Pick the size, power handling capacity, and price you need to match the function: public address, background music, intercom, outdoor, or whatever. We have 60,000 speakers, 135 different models, ready to transfer from our shelf to your wagon.

What makes a super speaker market? Super performance speakers. That's Quam, too. We use only top grade materials, stringent quality control, and advanced manufacturing methods to make sure our speakers work the way your customer expects them to.

Quam Nichols Company
Chicago, Illinois 60637
Phone: (312) 488-5800

Write for a copy of
our super new
Catalog 72



Quam: *The Sound Decision*

Circle 20 on reader service card

NOVEMBER 1972 • RADIO-ELECTRONICS 79

power. Power is "EI" which is voltage multiplied by current. So if your transformer has normal voltage and slightly less than normal current, your load circuits are not taking too much! If the transformer overheats, it may be the wrong transformer for this amplifier or it may even have a shorted turn in one of the windings. Check the transformer by pulling the rectifier tube, and disconnecting the hot wire to the heaters. In other words, take off all loads.

Now plug it into a wattmeter. Normal reading should be almost zero. All you should see is the iron-loss which will be below 5 watts. If the transformer has an internal short, you will read 25-

35 watts or more. If it shows no internal short, but still gets too hot, it may be that it doesn't have the right current-rating.

No wattmeter? Hook a 1-ohm wirewound resistor in the primary; read ac voltage across it. 1.0 volt equals 1.0 ac ampere.

A transformer is "too hot" when it melts the wax, smells, etc. It may run too hot to hold your hand on, but if it doesn't stink or smoke—it may be OK!

INTERMITTENT TRANSISTOR

In one of your articles, you said that transistors will not become intermittent. Not too long ago, I got a call on a Syl-

vania D-14 color chassis. After a lot of trouble, I found that the video output transistor was intermittent! I could move the collector lead and make it cut out, either in the circuit or on my transistor checker. Replaced it, and the set worked. Any comment?—G.W., Ipswich Mass.

Nope! Not too long after I did that article, I, too, found one! Same type as this, but used in an audio amplifier. Collector lead intermittent there, too. So I quit saying that you can't find intermittent transistors! Since then, I've heard of others.

Seems to be mostly this type of transistor; the little flat ones with 3 legs, bolted to the chassis, heat-sink etc. These are in "case-77" type cases. So far, none of the other cases have shown intermittents, but I'm waiting; and not sticking my neck out.

VERTICAL PROBLEMS

I've got all kinds of vertical problems in a Zenith 14N22 chassis. Can't get enough height with the proper linearity, the sync is bad, and you name it I've got it. I've checked all of the coupling capacitors for leakage, and the resistors read within tolerance.—L.C., Ink, Ark.

Y'missed one! Check the little PC integrator unit in the feedback loop, from output plate to "input grid"; PC-2 on the Sams schematic. You'll probably

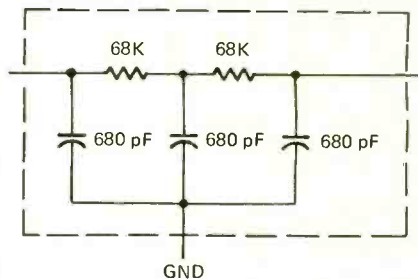

find that this thing is open. You should be able to read about 150,000 ohms from end to end, and about .001- μ F of capacitance from either end lead to the center (ground) lead.

Zenith part number is 87-7, and I think it can be replaced by a Centralab PC-90, etc. The diagram shows the equivalent circuit; if you have to, you can make up one of these from separate parts.

VERTICAL LINEARITY PROBLEMS

I had an Admiral HIA1 chassis, with a "no high voltage problem." Bad horizontal yoke coil. Since I happened to have a universal-type yoke that I picked up somewhere on hand, I tried it. Now I get high voltage, but the vertical linearity is pretty bad. Can't correct it with the controls.

This yoke, by the way had a label "DY-57AT" on it. Do you think this is a mismatch problem?—C.P., Stow, Mass.

I'm afraid I do! If your universal yoke is a Stancor DY-57, as it seems to

TV TUNER SERVICE

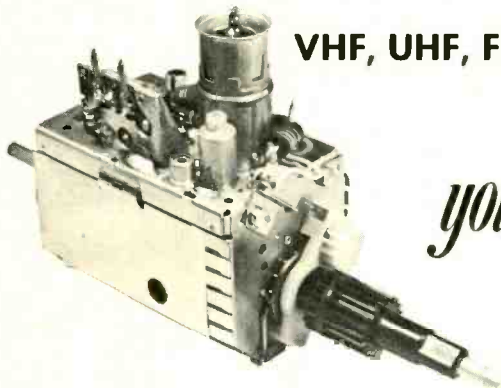

VHF, UHF, FM or IF-Subchassis. . .

. . . All Makes

you get...

Fast 8 hr. Service!

You owe it to yourself

to try P.T.S. We are the fastest growing, oldest and now the largest tuner service company in the world. Here is what you get.

1. Fastest Service—8 hr.—in and out the same day. Overnight transit to one of our six plants, for parts, tuners or IF-modules.
2. All tuners cleaned inside and out, repaired, realigned and air tested.
3. On IF-modules all stages checked, all traps set with high calibre test equipment.
4. Fine Quality! Your customers are satisfied and you are not bothered with returning your units for rework!
5. Lower Cost! Up to \$5.50 less than other tuner companies!
6. Friendly, helpful personalized service!

1 YEAR GUARANTEE



FIRST TO OFFER 365-DAY GUARANTEE!
 COLOR—BLACK & WHITE—TRANSISTOR TUNERS—
 ALL MAKES
 GUARANTEED COLOR ALIGNMENT—
 NO ADDITIONAL CHARGE

LIKE TO DO IT YOURSELF?

PTS makes all tuner parts available to you.

Send one dollar (redeemable) for our TUNER REPLACEMENT GUIDE AND PARTS CATALOG

- 60 pages of top information
- Blow-up of all tuners
- Largest exact tuner replacement guide
- Antenna Coil Replacement Guide
- Multi-fit Replacement Tuner Shaft Guide

We offer you finer, faster...

Precision Tuner Service

VHF-UHF-FM \$ 9.95
 UV-COMBO \$16.95
 IF-MODULE \$12.50

Major Parts charged at Net Price

CUSTOMIZED REPLACEMENTS AVAILABLE FOR \$12.95 UP (NEW OR REBUILT)

For fastest service, send faulty unit with tubes, shields and all broken parts to

PTS ELECTRONICS, INC.

HOME OFFICE—
 SOUTHEAST—
 WEST COAST—
 EAST—
 SOUTHWEST—
 MOUNTAIN—

P.O. Box 272—Bloomington, Ind. 47401
 P.O. Box 6771—Jacksonville, Fla. 32205
 P.O. Box 41354—Sacramento, Calif. 95841
 P.O. Box 3189—Springfield, Mass. 01103
 P.O. Box 7332—Longview, Tex. 75601
 P.O. Box 4145—Denver, Colo. 80204

Tel. 812/824-9331
 Tel. 904/389-9952
 Tel. 916/482-6220
 Tel. 413/734-2737
 Tel. 214/753-4334
 Tel. 303/244-2818

Circle 21 on reader service card

be, it'll have a vertical winding of about 70 mH. The correct replacement yoke for this Admiral chassis should be about 13 mH. You can get by with about a 20% mismatch in a lot of sets, but this is completely out of the ball-park.

Evidently your horizontal winding is close enough, but I'm afraid that you'll have to get a yoke that will be closer on the vertical.

HORIZONTAL OUTPUT TRANSISTORS?

The horizontal output transistors and the flyback have burned out on a Sony 9-304UW TV set. They use two 2SC41 transistors in parallel. Can't find a replacement for these. Any ideas?—W.J. McL., Phoenix, Ariz.

You might be able to replace these two with a single transistor with the proper ratings. For example, a Sylvania ECG-163, which is an npn, silicon, with a 700-volt breakdown voltage, and a rating of a whooping 100 watts peak. There are other similar types available.

For luck, run the ac line voltage up slowly with a Variac, watching the collector current, and output, etc. as you go. Normal current here is given as 520 mA per transistor. If the thing doesn't get too hot, fine.

(Note: we got some "field feedback" from the reader on this. He tried the single transistor, and it worked. Got pretty warm, but worked. Just for luck, he replaced the surviving 2SC41 in parallel with it (one of them turned out to be good!) whereupon both transistors cooled off, drew about 360 mA. apiece, and everything worked very nicely! Thanks to W.J. McLain, of Phoenix, for this one.)

BAND OF RIPPLES

I've got some of the most weird symptoms I've ever seen in this Motorola Quasar II TS-929 chassis. With a picture, there's a vertical "band of ripples" right in the middle of the screen, flickering with all colors! If I take the antenna off, I get very thick black vertical bars, odd shaped, like Barkhausen, but definitely not; they're all over the screen! I scoped the horizontal sync, and the sync-pulse goes all to pieces when the antenna is disconnected.—R.T., Hatfield, Ark.

I've seen this before. Uncommon, but it happens. Look for a very small rf choke, encapsulated, mounted on the plate-cap of the 6LF6 horizontal output tube. Take a piece of wire and short this choke! This will clear it up.

Apparently, this choke causes the horizontal output stage to ring heavily at some high frequency, and generate parasitic oscillations. Shunt it, and they quit! (Usually, the rf choke in the horizontal output plate lead suppresses spurious oscillations. However, in this case, it appears that the choke can cause hf or vhf oscillations.) **R-E**



Perma-Power Color Brite

**When the picture looks good,
you look good.**

When a color TV picture fades, or when the black-and-white is erased by a cathode-to-filament short, you can save the day, and the tube, by installing a Perma-Power Britener.

Boost models bring out lost sharpness and detail by providing increased filament voltage to increase electron emission. Full contrast and color quality return immediately.

Isolation models restore the black-and-white information that gives a color picture its quality, by isolating the short, thus restoring black-and-white video drive.

Short now . . . fade later? Handle

both jobs with a Color-Brite *Combination Isolation and Boost Britener*.

There are Perma-Power Color Brite models for both round tubes and rectangular tubes. In fact, Perma-Power has a Britener for just about every picture tube ever made! You'll look very good to your customer when you prolong the life of the expensive picture tube. Pick up a supply of Color-Brites from your Perma-Power distributor!



PERMA-POWER DIVISION
CHAMBERLAIN MANUFACTURING CORPORATION
5740 North Tripp, Chicago, Illinois 60646

Circle 22 on reader service card



give to the March of Dimes
THIS SPACE CONTRIBUTED AS A PUBLIC SERVICE BY THE PUBLISHER

new products

More information on new products is available from the manufacturers of items identified by a Reader Service number. Use the Reader Service Card inside the back cover.

LAB SCOPE, model KC-6060A combines a 1-kHz sinewave oscillator (with variable output level from zero to 1 V rms, regulated by front panel volume control) and a 3-inch oscilloscope (for waveform displays up to 200 kHz). Has 5-position selector to test 0.1 V peak-to-peak to compare voltage measurement of an input signal against a 1 kHz sine waveform; waveform left for left channel audio signal; waveform right for right channel audio sig-



nal; stereo display with left channel signal applied to vertical section, right channel signal to horizontal section; FM multipath to check performance of a tuner or adjust antenna. Can be used to check an amplifier for linearity, frequency response and phase characteristics; measure phase difference between two signals; test phono cartridges and more. \$224.95.—**Kenwood**, Dept. P, 15777 So. Broadway, Gardena, Calif. 90248.

Circle 31 on reader service card

PULSE GENERATOR KIT, model 701. A professional type instrument with all-integrated design, sockets for all integrated circuits and protected outputs. Pulse repetition rate: 10 Hz to 10 MHz in seven overlapping ranges; output pulse amplitude 0 to 5 volts across 50 ohms—0 to 10



volts unterminated. Pulse width: 50 nsec to 100 msec, in seven overlapping ranges. Duty factor: 90% at all frequencies. Rise and fall time is less than 5 nsec, jitter less than 0.1%, baseline offset 0 volts for both trigger and pulse outputs. Oscilloscope trigger output, 1.2-volt, 50 nsec width, 10

nsec rise and fall time. Output 50 ohms; instrument is short-circuit proof. \$159. (assembled \$220).—**Dytech Corp.**, 391 Mathew St., Santa Clara, Calif. 95050.

Circle 32 on reader service card

INTRUSION DETECTOR, *Sound Discriminator*. A series of intrusion alarms that operate with ordinary paging speakers as microphones. Can also be used with other sensors or switches. Discriminates against and rejects sounds for which a response is not desired. Model SD400AG, illustrated, has manual adjust-

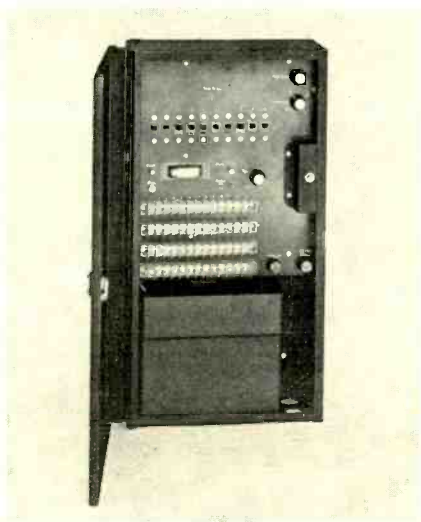

ment of reference ambient level and manual selection of number of events (2 to 5) to be received in an accumulation time period, to reject occasional and non-repetitive loud sounds. Units are available for 10 inputs up to 120 inputs.—**Scientific Security Systems, Inc.**, Jackson, Miss. 39216.

Circle 33 on reader service card

NOISE POLLUTION MONITOR, RCA WE-130. A hand-held, battery-operated unit for measuring sound levels in factories, airports, urban traffic areas and other high-noise areas.

The WE-130 uses solid-state circuitry and is powered by four penlight cells. Weight is a little over 11 ounces. Dimensions are 6 7/8 x 3 x 1 15/16 inches. The meter scale is divided into three parts. The green portion is the safe area; the yellow indicates levels bordering on the unsafe. Readings in the red indicate noise that can be dangerous to hearing if maintained for long periods.



A 32-page booklet—almost a simplified course in sound measurement—accompanies each instrument. \$75.—**RCA/Electronic Components**, 415 South Fifth St., Harrison, NJ 07029

Circle 34 on reader service card

BURGLAR ALARM SYSTEM, RA-IV. Completely self-contained wireless system operates on 117-volt ac or on its own dc supply should power fail. One central receiving station receives from any number of small wireless transmitters within 250-foot range. Transmitters use re-

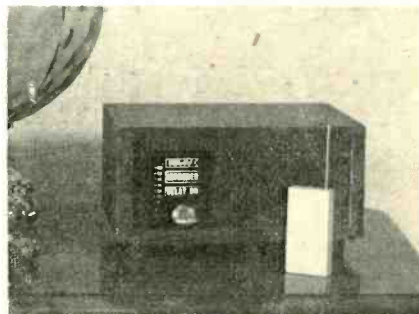

chargeable batteries that are good for six months normal operation, and can be recharged with unit that forms part of receiver. Alarm is a loud pulsating siren. \$159. (for receiver and one transmitter).—**Lumik**, P.O. Box 1312, Douglas, Ariz. 85607.

Circle 35 on reader service card

AIR ACTUATED SWITCH, T4 Air Wave Switch. Performs many alarm, detection or control functions cheaply where relatively expensive floor mats, motion detectors or light beams are often used. Typical application uses 100 feet of 1/8-inch inside diameter plastic tubing, which can be zig-

zagged under a carpet or mat or run through grass near a fence. A footfall on the tubing generates an air wave that actuates the switch. Contacts rated at 1A,

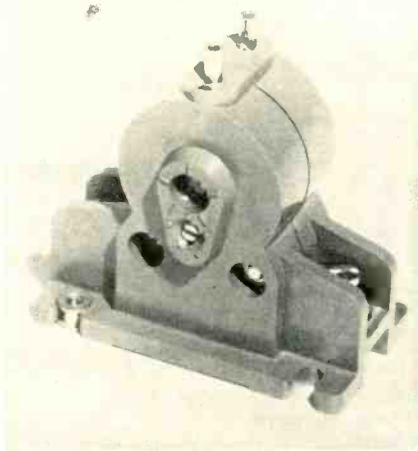

330V (ac). Switches cost less than \$15.—**Mountain West Alarm Supply Co.**, 4215 North 16th St., Phoenix, Ariz. 85016.

Circle 36 on reader service card

SCANNING MONITOR, SCAN 308. A programmable 3-band scanning monitor receiver covering 25-50 MHz, 140-174 MHz and 450-470 MHz simultaneously. Can be programmed easily to monitor any combination of eight channels in the high-band vhf, low-band vhf or uhf ranges. Visual



readout. Rear panel programming switches select the desired combination from the units total capacity of 16 channels. Built for both ac and mobile 12-volt use. \$189.95.—**Pace**, Box 306, Harbor City, Calif. 90710.

Circle 37 on reader service card

MICROWAVE INTRUSION DETECTOR, model A5-001 Space Switch, provides total premise protection by giving an alarm



triggered by forced entry through roof, wall, door or window. Unit is all solid-state

microwave uhf Doppler radar system. Protection is provided over as much as 3500 square feet or a 30-foot radius. Microwave transmissions penetrate most non-metallic structures and are reflected by metal. Movements from an intruder set off the alarm circuits, while a digital filter rejects movements of small animals and other false alarms. Powered by 117 Vac or optional 12 Vdc battery. Measures 3 3/4" x 6" x 7", weighs 4 lbs. \$185.—**Mountain West Alarm**, 4215 N. 16th St., Phoenix, Ariz. 85016.

Circle 38 on reader service card

TV TUNER SUBBER Mark II. Improved version has higher gain and longer battery life. Uses LED indicator. Substitutes the vhf tuner in defective TV receiver to prove if original tuner is good or bad. Simplifies

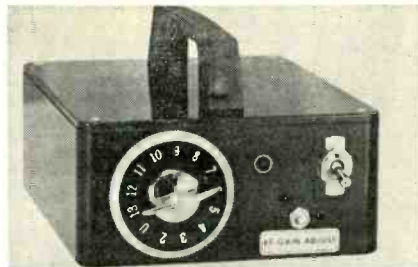

analyzing i.f. and agc system defects and tests the uhf tuner. Only two connections must be made, antenna and i.f. cable. Set of i.f. extension cables is furnished. Solid-state tester is battery powered. The portable unit uses a transistor vhf tuner with

external gain control affording a gain reduction range of more than 40 dB independent of receiver agc. \$31.95.—**Castle TV Tuner Service, Inc.**, 5710 N. Western Ave., Chicago, Ill. 60645.

Circle 39 on reader service card

LOW-COST CITIZENS BAND RADIO Pace 223. An all U.S. made two-way unit that provides all 23 channels of operation through a crystal synthesizing technique that compensates for temperature drift.



Reliable in sub-zero temperatures as well as hot desert climates. Full squelch control with 0.3 μ V threshold. Agc circuit holds volume essentially constant over a signal range of 0.5 μ V to 100,000 μ V (0.1 volt). Input power of 5 watts, with modulation boost circuit for maximum talk level performance within the class-D Citizens Band Radio regulations. U.S. made design includes use of U.S. made transistors and components, facilitating in-field servicing.

Pix-Mate™

the crt tester

you can afford to take along

only ... \$34.95



A quality CRT tester with individual test for each gun.

- Compare guns for emission.
- Test for leakage and shorts.
- Legible 3 color scale.
- Compact, portable, rugged.
- Avoid recalls, check the CRT on every call.

WRITE US!

TeleMatic

take along the time savers

- PIX-MATE • CRY-S-MATE • GEN-MATE
- SOUND-MATE • TRACE-MATE

The Caddy-Mate Line.

2245 PITKIN AVE., BROOKLYN, N. Y. 11207

Circle 61 on reader service card

**Now... the most enjoyable,
do-it-yourself project
of your life—a Schober
Electronic Organ!**



You'll never reap greater reward, more fun and proud accomplishment, more benefit for the whole family, than by assembling your own Schober Electronic Organ.

You need no knowledge of electronics, woodwork or music. Schober's complete kits and crystal-clear instructions show you — whoever you are, whatever your skill (or lack of it) — how to turn the hundreds of quality parts into one of the world's most beautiful, most musical organs, worth up to twice the cost of the kit.

Five superb models with kit prices from \$500 to around \$2,000, each an authentic musical instrument actually superior to most you see in stores, easy for any musically minded adult to learn to play, yet completely satisfying for the accomplished professional. And there are accessories you can add any time after your organ is finished — lifelike big auditorium reverberation, automatic rhythm, presets, chimes, and more.

Join the thousands of Schober Organ builder-owners who live in every state of the Union. Often starting without technical or music skills, they have the time of their lives — first assembling, then learning to play the modern King of Instruments through our superlative instructions and playing courses.

Get the full story FREE by mailing the coupon TODAY for the big Schober color catalog, with all the fascinating details!

The Schober Organ Corp., Dept. RE-108
43 West 61st Street, New York, N. Y. 10023

Please send me Schober Organ Catalog.
 Enclosed please find \$1.00 for 12-inch L.P. record of Schober Organ music.

NAME _____
ADDRESS _____
CITY _____ STATE _____ ZIP _____

Circle 62 on reader service card

\$109.95.—Pace Communications Div., Pathcom, Inc., P.O. Box 306, Harbor City, Calif. 90710

Circle 40 on reader service card

4-CHANNEL SYNTHESIZER, derives two additional channels from existing two-channel stereo material. Makes use of differential phase relationships of the two signals. The unit provides an easy, in-

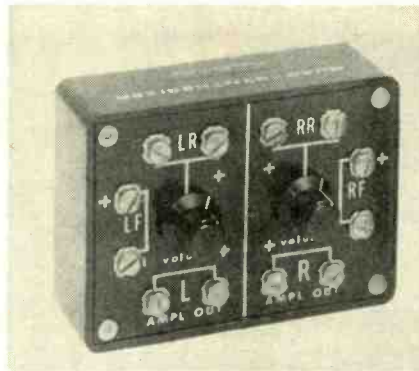

expensive way to sample 4-channel sound using two-channel stereo equipment. Basic model, \$6.95; with volume and balance controls, \$9.95.—Robins Industries Corp., 75 Austin Blvd., Commack, N.Y. 11725.

Circle 41 on reader service card

CONDENSER MICROPHONE KITS, PAC-1 and 2. PAC-1 is a kit for single microphone, with power supply; PAC-2 a two-microphone kit with dual power supply for 117-volt operation. PDC-1 and 2 are the

FREE catalog
over
1000
unique tools,
handy kits,
precision
instruments,
technical
supplies.

Our 20th year of service to the World's finest craftsmen and technicians.

National Camera
2000 West Union Ave. Dept. G58
Englewood, Colorado, 80110

Send a FREE copy of the nc Flasher

name _____
address _____
city _____
state _____ zip _____

National Camera
2000 West Union Ave. Dept. G58
Englewood, Colorado, 80110

Circle 63 on reader service card

equivalents for portable dc power supply. Microphone frequency response 50 Hz to 15 kHz, ± 5 dB; signal/noise ratio 50 dB; sensitivity -66 dB; cross talk less than 50 dB (based on PAC-2); output impedance 250 ohms unbalanced; maximum dynamic

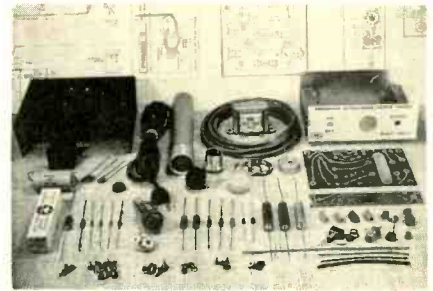

range 130 dB. FET amplifier is built into microphone body. Prices: PAC-1, \$79.50; PAC-2, \$139.50; PDC-1 (less battery), \$49.50; PDC-2 (less battery), \$99.50.—Electronic Enterprises, 3305 Pestana Way, Livermore, Calif. 94550.

Circle 42 on reader service card

MINIATURE RESISTANCE CALCULATOR, model R-1, makes available over 825 different values. The unit is a 10% step decade that covers 100 ohms to 11 meg-

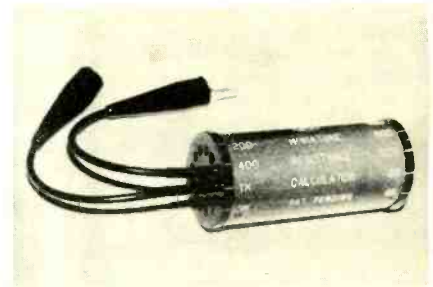

ohms. Can also be used as an automatic voltage divider with up to 25 different divisions. \$17.45.—Lee Electronic Labs, Inc., 88 Evans St., Watertown, Mass. 02172.

Circle 43 on reader service card

ELECTRONIC IGNITION SYSTEM, Capacitive-discharge kit, claimed to develop 50% more spark energy for complete combustion and increase spark magnitude to



3-5 times normal for faster acceleration and quicker starts, even in sub-zero weather. Unit can be used with any 4, 6, or 8-cylinder engine having a 12V negative-

ground electrical system. Measures 3" x 5" x 3 1/2". \$39.95.—**Radio Shack**, 2617 W. 7th St., Ft. Worth, Tex. 76107.

Circle 44 on reader service card

SIREN VEHICLE ALARM, model DU-272. When armed, the dual-purpose lock does not allow the ignition to be started. Should an intruder attempt to open any of the doors, hood or trunk, the siren sounds and



continues to sound until it is turned off by the owner with a special alarm key.—**On Guard Corp. of America**, 350 Gotham Parkway, Carlstadt, NJ 07072.

Circle 45 on reader service card

AC CURRENT-LEAKAGE ADAPTER, model 60-407, measures leakage current of 2-wire and 3-wire appliances, small portable power tools, speed controls, motors and other electrically operated devices. Tester is used with Triplet's Model 601

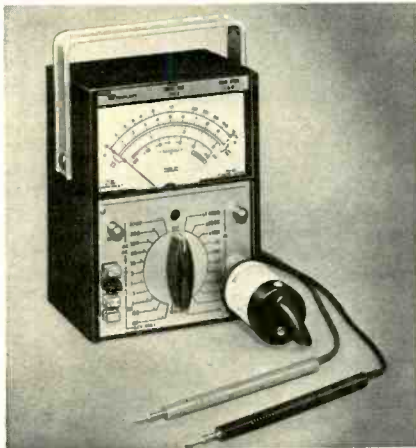

FET vom. Ac leakage currents that can be measured are 0 to .01-.03-.1-.3-10-30-100 mA. Resolution is 0.2 μ A on the 0-.01 mA range. Accuracy is 4% full scale.—**Triplet Corp.**, Bluffton, Ohio 45817.

Circle 46 on reader service card

OMNIDIRECTIONAL MICROPHONE, Model 655AL, is designed to accurately reproduce instruments in a live performance. Has a frequency response of 50 to 15,000 Hz and an output impedance of



150/250 ohms. Flat response provides faithful reproduction of drums, acoustic guitars and other musical instruments requiring exacting sound fidelity. Pickup pattern is also excellent for group vocal work on stage or in the studio. Pop and wind blast filtering precludes the need for a wind screen outdoors. Also available in a high impedance, model 655AH.—**Ling Altec, Inc.**, 1515 So. Manchester Ave., Anaheim, Calif. 92803.

Circle 47 on reader service card

SPEAKER GUARD, consists of a resistor and circuit breaker that can be easily connected in series with the speaker. A wattage overload from the amplifier output activates the circuit breaker and prevents damage to the speaker. Resetting the circuit breaker

resets the unit. *Speaker Guard* is available in 18 different models with varying combinations of wattage and resistance—**Workman**

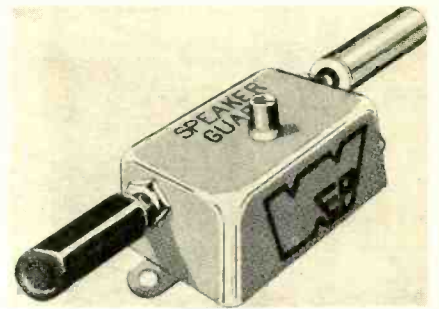

Electronic Products Inc., Box 3828, Sarasota, Fla. 33578. R-E

Circle 48 on reader service card

RCA CONSUMER ELECTRONICS SERVICE DATA SUBSCRIPTIONS



A SUBSCRIPTION INCLUDES A COMPLETE "FILE" YEAR OF:

- COLOR TELEVISION DATA
- B & W TELEVISION DATA
- RADIO DATA
- PHONOGRAPH DATA
- TAPE RECORDER DATA
- "GOLDENROD" BULLETINS
- PARTS TIPS
- SERVICE TIPS
- "PLAIN TALK" PERIODICALS
- COMPLETE INDEX

- "File-1972" Service Data including 2 binders \$19.95
- "File-1972" Service Data subscription \$14.95 (Binders available separately—\$2.95 each)
- Previous years Data (\$12.50 per set) File: 71 , 70 , 69 , 68

Amount enclosed: \$ _____

NAME _____

(Please Print)

STREET ADDRESS _____

CITY _____ STATE _____ ZIP CODE _____

- Your order will be processed promptly upon receipt of your check or money order in the amount indicated above

SEND TO: **RCA CONSUMER ELECTRONICS**
600 N. Sherman Drive, Indianapolis, Ind. 46201

ATTN: Technical Publications, 8-106 (Or Contact Your Distributor)

Note: Prices Subject To Change Without Notice

Postpaid U.S.A. only

Circle 64 on reader service card



**Attention
Electronic
Technicians!**

**SCHOOLING
OF
EXCELLENCE
in ELECTRONICS
ENGINEERING**

If you have adequate schooling and experience at the technician level you may be able to qualify to enter our college-level Home Study Program in Electronics Engineering. The CIEE Program is **OUTSTANDING**, and up-to-date in every respect. CIEE is a forward-looking school, and Engineering is taught on the basis of application and understanding rather than on the basis of memorization. All lesson material and texts are thorough and easy-to-understand. Through this Highly Effective Home Study Program in Electronics Engineering you can raise your status and pay to the Engineering level. No residence classes required for those who qualify. If you are an electronics technician with above-average ambition, and not willing to settle for anything less than the best home study Engineering Schooling available anywhere, then you should write **TODAY** for our free revealing descriptive literature. There is no obligation, and no salesman will call on you.

**COOK'S INSTITUTE
of Electronics Engineering**

Raymond Road
P. O. Box 10634
Jackson, Miss. 39209

Established 1945
Formerly Cook's School of Electronics

Circle 65 on reader service card

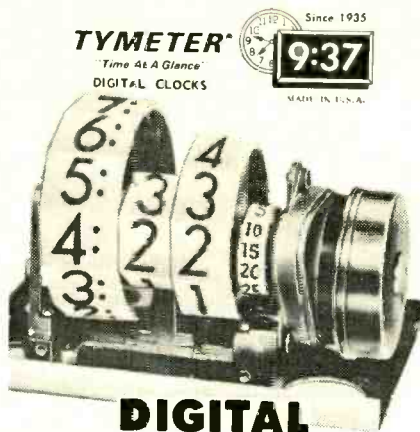

**DIGITAL
CLOCK MOVEMENTS**

#130...12 HOUR #131...24 HOUR

DIGITS RESETTABLE INDIVIDUALLY

Available in 50, 60 c.v., all voltages, AC. UL approved motor, cord. One Year Guarantee.

#75
Tymeter
Elapsed
Time
Digital
Computer



Complete Line of Count-Up and
Count-Down Digital Computers

CATALOG ON REQUEST

PENNWOOD NUMECHRON CO.
TYMETER ELECTRONICS
DIVISION OF LCA CORPORATION
7249 FRANKTOWN AVE., PITTSBURGH, PA. 15208

Circle 66 on reader service card

new lit

All booklets, catalogs, charts, data sheets and other literature listed here with a Reader Service number are free. Use the Reader Service Card inside the back cover.

ELECTRONIC PARTS & EQUIPMENT CATALOG, 48 pages packed with all kinds of useful electronic devices. Included are such things as picture tubes, vacuum tubes, hi-fi components, tools, rectifiers, books and test equipment—**Cornell Electronics Company**, 4217 University Ave., San Diego, CA 92105.

Circle 49 on reader service card

TV/FM ANTENNA INSTALLATION GUIDE, 10 page booklet covers antenna selection, masts, mounts, lead-in wire, lightning protection and multi-set systems. Illustrated with a series of complete pictures and diagrams, the guide gives the reader step-by-step instructions on various types of home antenna installations. The guide also gives a clear explanation on how to protect the installation from wind and weather, how to prevent damage to the roof and the house and how to make the installation as solid as possible.—**Jerrold Electronics Corp.**, 401 Walnut St., Philadelphia, PA 19105.

Circle 50 on reader service card

PHYSICS & ELECTRONICS CATALOG, 10 pages of classroom demonstrators and potential science fair projects. Includes such things as a parametric ac motor, oscillating magnet, motion detector demonstrator, perpetuum Mobile and many other items of interest.—**Sercolab**, P.O. Box 78, Arlington, MA 02174.

Circle 51 on reader service card

Write direct to the manufacturers for information on items listed below:

SILICON RECTIFIER CATALOG, six pages detailing this manufacturer's entire line of standard and fast-recovery silicon rectifiers. The new catalog devotes individual pages to ratings and electrical characteristics as well as dimensional drawings of case styles for EDI bridges, high voltage axial lead rectifier cartridges, high voltage rectifier assemblies and miniature axial lead rectifiers—**EDI**, 21 Gray Oaks Avenue, Yonkers, NY 10710. **R-E**

**THINK OF IT
AS A CHEMICAL
ULTRASONIC BATH**



The moment you do, you'll improve the way you service tuners and other greasy chassis troublespots. You'll save time, as a concentrated power spray dissolves and washes away dirt and gunk. You'll save money—less spray is needed because there's a higher percentage of active ingredients. And you'll do a more thorough job—thanks to a premium formula that's more efficient and won't damage components.

Next time you service, service chemically with the world's best-selling degreaser—**TUN-O-WASH #2400**. One of the fine chemical tools from

CHEMTRONICS INC.
1260 RALPH AVENUE
BROOKLYN, N.Y. 11236



Our business is improving yours.

Circle 67 on reader service card

GIVE...
so more will live
**HEART
FUND**

EQUIPMENT REPORT
(continued from page 26)

the positive (upward) or negative (downward) slope of a waveform. The fourth is the triggering AUTO-NORM switch. In the AUTO position, the ac/dc triggering switch and the trigger level control are disabled. This position is useful for signals which are too weak to trigger the sweep circuits in the normal fashion or for triggering simple waveforms. The NORM position of the switch is used for other signals and, particularly, for low-frequency signals.

Construction of this oscilloscope is not a simple project. The IO-105 packs an awful lot of circuitry into a compact case. Six printed circuit boards are used (the two vertical amplifier boards are identical). Instructions are straightforward and, in the usual Heath fashion, assembly follows a logical sequence.

Because of the complexity of the instrument's circuitry, calibration is necessarily much more time-consuming than with a simple scope. However, the calibration instructions are straightforward and easy to follow. Two procedures are given, one for calibration without a calibrated generator and the other with generator.

One of the great joys of this instrument is the stability of the calibration and balancing adjustments. After using the instrument for several weeks, a spot check was made of many of the adjustments to see if they had drifted away from their original settings. They had not. One of the reasons for this stability is undoubtedly the extensive use of voltage-regulated circuits in the power supply. Many Zener diodes are used. In addition, because of the solid-state circuitry, the high temperatures of tube-type equipment, with all their bad effects on stability of calibration adjustments, are eliminated. All in all, this is a superb instrument. Price of the kit is \$399.95.

A high-impedance, low-capacitance isolating probe is available as an accessory for examining high-frequency waveforms without distorting them or loading the circuit being tested. This probe is sold only as a wired unit at \$19.95.

R-E



Your little joke with the fake cord really startled me, Mr. Conrad—almost as much as this bill for the service call is going to startle you.

Unbeatable values from Supersonic!

8-track car players

superbly engineered—all solid state!

FREE! 8-track tape of latest hits with every order. (Reg. \$6.00)



Model CXC-771 "Mecca" 18 watt car stereo mini 8-track cartridge player. Fits in any glove compartment. \$27.95



Model CXC-772 "Granada" 8-track player. Easy wheel-type volume, tone & balance control. Powerful 20 watt amplifier for great stereo music in your car. \$29.95



Model CXC-773 "Mecca" 8-track car player & FM multiplex radio. Fantastic 20 watt stereo sound. One touch changes FM to tape or multiplex to monaural, lighted dial, stereo light indicator. Sleek chrome & black styling. \$62.95
Model CXC-774 same as above with FM & AM — \$69.95

All units with automatic & manual lighted push button channel changer.

2 hi-quality speakers for all above units \$4.00. Easy installation instructions.

Supersonic Electronics Co.

192 Hooper St. Dept. A, Brooklyn, N.Y. 11211

Circle 68 on reader service card

Send check or money order. Add postage. All items fully guaranteed. Free catalog.

GIVE ... so more will live HEART FUND



Contributed by the Publisher

Under \$180. Sounds great.

You may have thought it was impossible to buy a good complete magnetic stereo system for under \$180. Now it's possible. From BSR. It's the BSR McDonald RTS-30. With an FM-AM receiver that delivers 30 watts of clean music power. Included are a pair of our SS-1 acoustically matched speakers and our best selling 310/X Total Turntable with base, dust cover and Shure M-75 magnetic cartridge. Our RTS-30. A magnetic system at a price you would pay for a ceramic. Even we're a little amazed.



BSR (USA) Limited, Blauvelt, N.Y. 10913

I'm interested. Send free catalog on all your stereo systems and components.

Name _____
Address _____
City _____
State _____ Zip _____

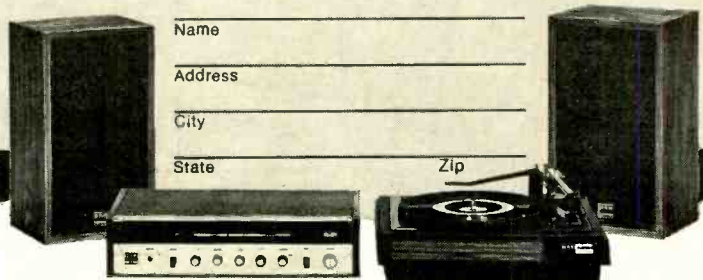

Circle 69 on reader service card

To Troubleshoot
FAST & EASY
use: Serviset

Model EC
PATENTED



\$34.95

Postpaid
COD

FREE
INFORMATION

A precision engineered professional quality electronic test instrument. Ideal for field or bench servicing of all types of Communications gear.

CHECKS: sync, sweep, video, audio circuits, high voltage supplies (DC, RF or Pulse), low voltage supplies, coils, capacitors, resistors, tubes, transistors, diodes, transformers, speakers, etc. Will locate trouble to a particular stage, determine defective component and can actually be clamped in circuit to restore circuit operation temporarily in 80% of component or tube defects. Ideal for locating and confirming intermittents.

SPECIFICATIONS:

RF & AF Signal Tracer, RF & AF Signal Injector, AC & DC Voltage Indicator 0/60/550/20,000 DC Polarity Indicator 60/550/20,000 volts, Lo ohms 0-5. Hi ohms 0-500k-20 meg-ohms. Tests Condensers, .00025-12 mfd., Tests Resistors 2 ohms-20 megohms, 2 Capacitance Sub ranges .01-.1 & 4-40 mfd., 3 Resistance Sub ranges 50-500 ohms, 5k-25k, 100k-1 meg.

NEW CT-1

From 
Will allow you
to Dynamically test all
types of capacitors.



The Model CT-1 features a built-in electronic power supply providing BOTH AC and DC Test Voltages in a special circuit with highly sensitive NEON type leakage indicator. The CT-1 permits quick, accurate testing of condensers for leakage or shorts with actual DC voltage applied and readily indicates intermittent OPEN condensers with AC applied. Self-regulating power supply circuit provides tapered forming current to suit particular requirements of capacitor under test. Special circuit re-forms and polarizes electrolytic and tantalum capacitors under test. High sensitivity permits determination of condenser dielectric breakdown before leakage causes major shut-down.

Only **\$16.95** postpaid

Capacitor Range: .00025 — 1000 mfd.
Sensitivity: Over 200 MEG OHMS

30 DAY MONEY-BACK GUARANTEE

LEE ELECTRONIC LABS., CO.

88 Evans Street
Watertown, Massachusetts 02172
Dealer inquires invited

appliance clinic

INSIDE THE CLOTHES DRYER

by **JACK DARR**
SERVICE EDITOR

CLOTHES-DRYERS, LIKE MOST MAJOR appliances, aren't really too complex. They all have the same parts; a large perforated drum, turned at a low-speed by a motor; a heater and fan, to blow hot air through the drum; a thermostat to control the air temperature; and an electrical driven timer to control the entire process.

In the electrically heated dryers, large heating elements are mounted in the air duct, with a fan to force the hot air through the drum. The majority of these use 240-volt heaters. Elements run from 2,000 to 5,000 watts. The heating elements have three controls; the switch contacts in the timer, which will probably operate a relay to switch the high currents, and a thermostat acting as a limit switch. This breaks the heater circuit when the temperature rises above the desired point.

So if the problem is "The drum turns but the clothes stay cold." you have one of four possibilities. Open switch contacts in one of the three controls just mentioned, or an open heating element. Many of the later model dryers have multiple-section heaters, for different heats. So, the chances of all of these opening at once would be small. A complete loss of heat would be most likely to be in the three switches.

To check for this, pull the machine out from the wall, pull the line plug and take the back off. Usually this will be fastened with self-tapping screws around the edges. In a great many units, you'll find a complete wiring diagram pasted to the back or inside the cabinet. With this, it isn't too hard to find the wires going to the heaters and trace them out. With a continuity meter, the various switch contacts can be checked by turning the timer knob manually to the right position.

In the flat-top types, with controls mounted on a splash-board (vertical surface at the back of the top) many of the controls will be quite accessible. In several models, the whole top can be slid back and lifted up, exposing all heater wiring, controls, etc. A lot of the wiring, including the timer, will use push-on connectors, which makes it very handy to check.

The thermostat can be hard to get to in some, especially if it is mounted inside the air-ducts. However, you can trace the wiring from the timer and controls, and locate the leads to it. Pull these loose and you can check the contacts for continuity. If the dryer is cold, the contacts should be closed, of course. If you get an open-circuit reading across the thermostat leads, its contacts aren't making. Take it off and check the contact surfaces for burning or pitting. If they are badly burnt, it would be best to replace the thermostat. Filing down the points would change the spacing, and probably make the thermostat lose calibration. Be careful while handling them, since calibration can also be upset by bending the blade. Some units use a "snap-action" thermostat, making use of what is called the "oil-can effect"; these are not easily upset.

If the drum won't turn, but you can hear the motor running, you've got a belt problem. This is accessible as soon as you take the back off. If the belt has jumped off, check the alignment of the driving and drum-pulleys, and the motor mounts. Failure or breakage of one of the motor mounts can throw the motor out of line and the belt will jump as soon as it's started the next time.

If the belt is broken, take the old one to an appliance supply house to be sure you get the right length and size replacement belt.

Some units use a spring-loaded idler arm. It moves to tighten the belt and make the drum turn. Check the control linkage, springs, and bearings on this. The whole thing is usually easy to get at, and adjustments are simple, mechanical. If the idler arm doesn't hold the belt against the pulleys tightly enough, it will slip, causing rapid wear and short belt life. With the arm engaged, the belt should have only a small amount of slack.

The timers are driven by a small electric motor, similar to electric clock motors, mounted on the back of the switching unit. In many makes, this motor can be replaced without changing the whole timer. Two screws hold them in place, on a bracket.

If the whole timer must be re-

placed, the push-on connectors make this job a lot easier. Color-coding of wires is used extensively, and the whole thing should be shown on the wiring diagram. If this isn't clear enough, or if it doesn't show color-coding, make up your own drawing of the wires.

The best way, if a timer must be replaced, is to leave the old one in place until you have the replacement. Then, unbolt the old one, and pull it away from the panel, leaving the wires connected. Mount the new unit, and then transfer the wires to it, one at a time. Much less chance of confusion.

Fan/blower problems are usually fairly obvious. If the fan doesn't run, check the belt. Many of these are driven from the drum motor; others have their own small motor. Most of these are mounted on some kind of shock-mount—rubber pads, etc., to prevent excessive noise and vibration. If these mounts have gone bad, from old age or heat, the fan-blades can hit the sides of the duct, making a terrible uproar. It's a good idea to check all rubber mountings like this, whenever you have the back off the dryer.

All in all, you shouldn't find any really complex problems in modern clothes dryers. Simple electrical equipment, such as a vom for checking continuity and ac voltage, will tell you what's going on (or not going on, as the case may be). **R-E**

A MIND IS A TERRIBLE THING TO WASTE.

A lot of the young people we help would never get to college without financial aid.

With your help, we can help more of them. Please send a check. Whatever you can afford. To 55 East 52nd Street, New York, N.Y. 10022.

We just can't afford to waste anybody.

GIVE TO THE UNITED NEGRO COLLEGE FUND.

advertising contributed for the public good



COMMANDER COMMUNICATOR

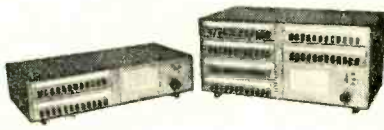

YOUR Pushbutton Valet

Your Pushbutton Valet will run your verbal errands and find that hard-to-locate person. With locking light and ringer, he remembers your calls so that when you return to your desk they may be answered. If you ask, he jealously protects your privacy, or the flip of a switch will give you hands-free reply to incoming calls. Or with an optional handset your Pushbutton Valet will protect the privacy of your incoming calls. With his magic 100 watt booster amplifier he can page over 100 loudspeakers at one time. Your Pushbutton Valet never tires and never wears out. Where most intercoms have maximum capacity at 12 or 24 switches, the Pushbutton Valet can grow to 72 switches or even more on special order. With the Pushbutton Valet at your side you will indeed be called the Commander Communicator. Write, wire or call

Nelson-Herskfield Electronics

1848 WEST CAMPBELL AVE. PHONE:
PHOENIX, ARIZONA 85015 602-264-1348

Circle 70 on reader service card

SPEAKER GUARD

PROTECTS SPEAKER AND AMPLIFIER



An overload in wattage of amplifier output activates circuit breaker and prevents damage. Reset circuit breaker and make sure you use correct values of Speaker Guard.

18 DIFFERENT VALUES

ASK FOR CAT. # 145C
WORKMAN Electronic PRODUCTS, INC.
CORPORATION • 1100 TECHWOOD TOWER
BOX 3828 SARASOTA FLA 33578

Circle 71 on reader service card

Why pay an answering service when you can own your own?



Dictaphone has a machine to make sure you never lose another cent through a missed phone call or a garbled message. In fact, we have a whole line of them.

They're called Ansafones. You can buy one outright or possibly lease it for about what you're paying your answering service now. And it works for you 24 hours a day, 7 days a week.

For a free brochure describing how much an Ansafone can help you, mail this coupon now.

▶ Dictaphone

Box L-11-34, 120 Old Post Road, Rye, New York 10580
Please send me full details of the Ansafone line.

Name _____

Company _____ Phone _____

Address _____

City _____ State _____ Zip Code _____

Ansafone and Dictaphone are registered trademarks of Dictaphone Corp.

Circle 72 on reader service card

ELECTRONIC TECHNICIANS!

Raise your professional standing and prepare for promotion! Win your diploma in

ENGINEERING MATHEMATICS

from the Indiana Home Study Institute

We are proud to announce two great new courses in Engineering Mathematics for the electronic industry.

These unusual courses are the result of many years of study and thought by the President of Indiana Home Study, who has personally lectured in the classroom to thousands of men, from all walks of life, on mathematics, and electrical and electronic engineering.

You will have to see the lessons to appreciate them!

NOW you can master engineering mathematics and actually enjoy doing it!

WE ARE THIS SURE: you sign no contracts—you order your lessons on a money-back guarantee.

In plain language, if you aren't satisfied you don't pay, and there are no strings attached.

Write today for more information and your outline of courses.

You have nothing to lose, and everything to gain!

The INDIANA HOME STUDY INSTITUTE

Dept. RE-11, P.O. Box 1189, Panama City, Fla. 32401

Circle 73 on reader service card



WANT TO KEEP THINGS QUIET? AND CLEAN TOO?

Then use Quietrole... the choice of better servicemen everywhere for cleaning and lubricating all T.V. moving parts.

Spray Pack guarantees silent, smooth operation, with absolutely no harmful aftereffects for both color, and black and white sets.

Also available in bottles if you prefer.



Product of

QUIETROLE

COMPANY

Spartanburg, South Carolina

Circle 74 on reader service card

try this

INTERCHANGEABLE PROBE TIPS

In a very short time, you can make up a set of test probes with interchangeable tips that can save time when servicing printed circuits and wiring in miniature electronic assemblies. The basic test prods are leads with banana jacks.

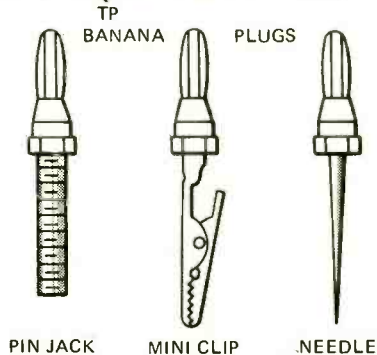
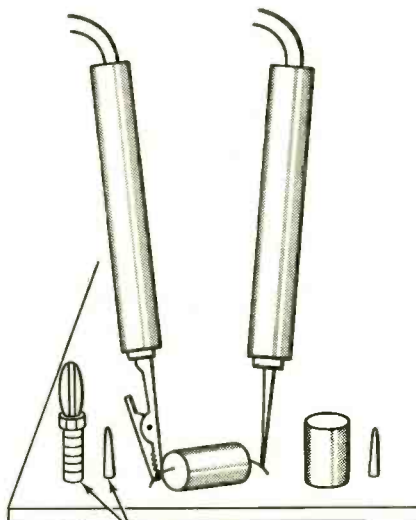
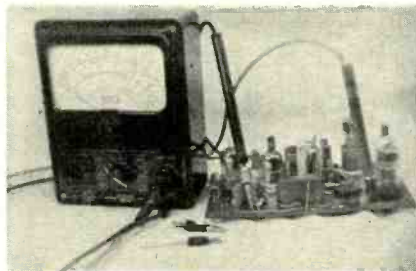

The first test tip consists of a pin jack back-to-back with a banana plug. The jack end of this tip fits snugly over test points and terminals in many receivers. The second and third tips consist of banana plugs backed-up by a miniature alligator clip and a press-fit needle-point. —Peter Legon R-E

MODERN CIRCUIT BOARDS

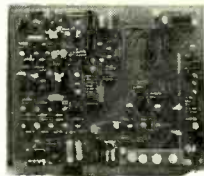

J9404



J9405

J9404, 32 late no. marked xistors, 4 TO-5 ICs, resistors, capacitors DIP sockets etc.

STOCK NO. J9404 3.00 ea. 3/8.00

J9405, 23 marked xistors, 8 TO-5 ICs, resistors, caps, DIP socket, LSI socket.

STOCK NO. J9405 2.50 ea. 3/7.00

ONE EACH J4904 & J4905 \$5.00

TRANSFORMER SPECIAL

Ideal transformer for NIXIE tube circuits. 3 center tapped windings, 30 volts 1 amp., 16 volts 3 amps. and 150 volts 100 ma.

STOCK NO. J9254 \$3.00 ea.

COMPUTER GRADE CAPACITORS (BRAND NEW)

40,000 mfd. 10 volts 1.25 ea. 6/7.00 Stk. No. F2026
70,000 mfd. 10 volts 1.75 ea. 6/9.00 Stk. No. F2118
6,000 mfd. 55 volts 1.50 ea. 7/9.00 Stk. No. F2117
3,750 mfd. 75 volts 1.75 ea. 6/9.00 Stk. No. F2116

Many other items. Send for new 48 page catalog. All merchandise guaranteed. Please include sufficient postage, excess will be refunded.



DELTA ELECTRONICS CO.

BOX 1, LYNN, MASSACHUSETTS 01903

Phone (617) 388-4705

Circle 75 on reader service card

NEW, FREE FIRE/BURGLAR ALARM CATALOG

64 pages presenting 350 intrusion and fire alarm products for today's skilled alarm installers and electronic technicians. Includes the latest systems and detectors, hard-to-find parts, accessories, and technical application notes on uses and circuit designs.



mountain west

alarm supply co.

4215 NORTH 16th STREET
PHOENIX, ARIZONA 85016

Circle 76 on reader service card

new books

ABC'S OF ELECTRONICS, by Earl J. Waters. Howard W. Sams & Co., Inc., 4300 W. 62nd St., Indianapolis, IN. 46268. 8½ x 5½ in. 160 pp. Softcover, \$3.95.

This latest edition is an easy to grasp, but comprehensive introduction to the broad field of electronics. The author avoids complicated technical concepts and mathematical terms as much as possible and relies on simple language and on analogies familiar to everyone. The text presents a detailed analysis of the principles of the principles of electricity, functions of atoms and electrons, magnetism and solid-state physics. Individual chapters are devoted to electrical resistance, capacitance and inductance. The remainder of the book deals with alternating currents, circuit impedances, electro-magnetic radiation, vacuum tubes, transistors, integrated circuits, radio wave production and propagations and the various electro-mechanical devices.

ENCYCLOPEDIA OF INSTRUMENTATION AND CONTROL, by Douglas M. Considine, Editor-in-Chief. McGraw-Hill Book Co., 330 W. 42nd St., New York, NY 10036. 9½ x 7¼ in. 788 pp. Hardcover, \$29.50.

Bringing together the many facets of scientific information which can be termed instrumentation and control technology, this comprehensive Encyclopedia provides a bridge between the underlying principles and the techniques of applying instruments and controls to whatever work there is to be done. Of great importance to the user, the Encyclopedia is a convenient desk reference, designed for rapid and easy use. Fully cross-referenced, with in text cross references as well, it contains an extensive alphabetical index, a classified index and a contents wheel to permit the user to locate desired information rapidly.

1972 POPULAR TUBE/TRANSISTOR SUBSTITUTION GUIDE, by TAB Editorial Staff. TAB Books, Blue Ridge Summit, PA 17214. 8½ x 5½ in. 256 pp. Vinyl Cover, \$4.95. Papercover, \$2.95.

New up-dated and expanded edition of the only substitution guide available that lists best substitutes for all popular tubes and transistors. The new volume contains eight sections, four devoted to tubes and four to transistors. Section I provides a cross-reference of popular American receiving tubes. Section II lists substitutes for popular tube types found in commercial and industrial equipment. Section III provides a cross-reference of popular foreign/American tube types and Section IV shows the base diagrams for all tubes. Section V is a complete listing of popular American transistors. Section VI lists American substitutes for the most often encountered foreign transistors. Section VII lists general-purpose replacements. Section VIII presents base diagrams of transistors.

HOW TO REPAIR ELECTRICAL APPLIANCES, by Gershon J. Wheeler. Reston Publishing Co., Inc., Reston, VA. 9¼ x 6¼ in. 224 pp. Hardcover, \$10.00

Using this book, it is possible to fix anything from a faulty lamp switch to a washing machine by following the easy step-by-step instructions. The basic methods described are clear, safe and useful to any man or woman who owns an appliance. Some of the many items covered in the text include heating pads, waffle irons, electric irons, vaporizers, three-way lamps, solenoids, blenders, can openers, garbage disposals, dish washers.

COMMERCIAL RADIO OPERATOR THEORY COURSE, by Martin Schwartz. Ameco Publishing Corp., 314 Hillside Ave., Williston Park, NY 11596. 9 x 6 in. 448 pp. Softcover edition, \$5.95.

An ideal book for anyone studying for his first or second class commercial radio operator's license. It is complete in its coverage of radio theory and it covers all the information needed to pass the FCC exams. In addition, over six hundred FCC-type multiple choice questions are given. No previous technical experience is required since the course starts with basic electricity.

PULSE & SWITCHING CIRCUITS, by Harvey F. Swearer. TAB Books, Blue Ridge Summit, PA 17214. 5¼ x 8¼ in. 254 pp. Hardcover, \$7.95.

For anyone interested in the science of electronics, particularly those involved in its practical day-to-day aspects, the use of pulse and switching circuits is a vital concern. There is hardly a phase or field of electronics untouched by some form of pulse and switching applications. This book is not an engineering text; it is a practical examination of pulses, the circuits that shape them and the variety of ways they can be put to work. It begins with an examination of pulses, basic definitions and pulse parameters. From there it continues to progress to pulse generators and circuit response characteristics. The remainder of the book is devoted to a variety of practical, everyday applications, including remote control, computers, radar, telemetry and various automation devices.

R-E

Introducing the expensive dual-trace scope that doesn't cost a lot.

The B&K Precision Model 1470.

The compact 5-inch solid-state 1470 is specially designed to meet 80% of all industrial scope applications.

It has DC to 10 MHz bandwidth with 10 mV/cm sensitivity. Sixteen triggered-sweep speeds range from 1 µsec/cm to 0.2 sec/cm. Triggers on input signals as low as 5mV.

\$499⁹⁵

Sound good? Our prices

become even more remarkable once you see our specs.

Call your B&K distributor. Or write Dynascan Corporation.

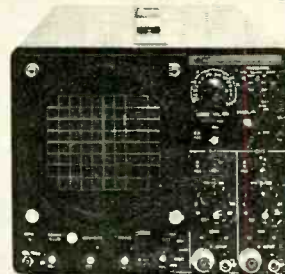

In stock at your parts distributor.



Product of Dynascan Corporation
1801 West Belle Plaine Avenue, Chicago, Illinois 60613

Circle 77 on reader service card

Designed and manufactured in U.S.A.

NEVER A BURNOUT
IN 4 EMC DIODE-PROTECTED VOMS



NOBODY ELSE BUT EMC DESIGNS IN SO MUCH VALUE!

- Professional quality and versatility
- Life-time protection against electrical abuse
- No meter burnout, needle damage, or fuse replacement

VOLOMETER

Model 109A Factory Wired & Tested \$30.95

Model 109AK Easy-to-Assemble Kit \$22.65

20,000 Ω/v DC sens. 10,000 Ω/v AC sens.

4½", 40µa meter. High impact bakelite case.

5 DC voltage ranges: 0-6-60-300-600-3000v.

5 AC voltage ranges: 0-12-120-600-1200-3000v.

3 DC current ranges: 0-6-60-600ma.

3 AC current ranges: 0-30-300ma; 0-3A.

3 resistance ranges: 0-20K, -200K, -20 megs.

5 db ranges: -4 to +67db. With carrying strap.

5¼" W x 6¾" H x 2⅞" D.

POCKET SIZE VOLOMETER

Model 102A

Factory Wired & Tested \$18.95

Model 102AK

Easy-to-Assemble Kits \$15.95

3½", 2% accurate 800µa D'Arsonval type meter.

One zero adj. for both res. ranges. High impact bakelite case.

5 AC voltage ranges: 0-12-120-600-1200-3000v.

5 DC voltage ranges: 0-6-60-300-600-3000v.

3 AC current ranges: 0-30-150-600ma.

4 DC current ranges: 0-6-30-130ma; 0-1.2A.

Resistance: 0-1K, 0-1 meg. 3¼" W x 6¼" H x 2" D.

Send FREE catalog of complete EMC line and name of nearest distributor.

RE-11

Name _____

Address _____

City _____

State _____ Zip _____

EMC

ELECTRONIC MEASUREMENTS CORP.
625 Broadway, New York, N.Y. 10012

TRUE TRIGGERED SWEEP OSCILLOSCOPE/VECTORSCOPE

MODEL TO-50

- DC to 10 mhz frequency response
- .02 volt sensitivity
- Calibrated vertical attenuator
- Calibrated time base
- Supplied with combination Direct/Lo-Cap probe
- 5 X magnifier
- Automatic triggering mode
- 5" flat face tube edge-lit graticule

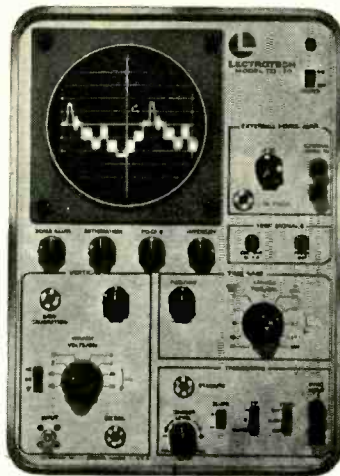

One Year Warranty **339⁵⁰**
Made in U.S.A.



See your distributor or write Dept. RE-11

LECTROTECH, INC.

5810 N. Western Ave., Chicago, Illinois 60659

Circle 78 on reader service card

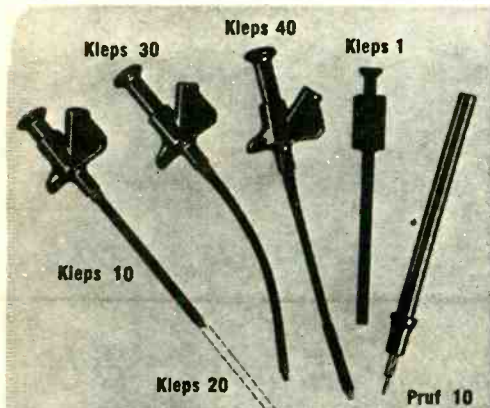

Clever Kleps

Test probes designed by your needs — Push to seize, push to release (all Kleps spring loaded).

- Kleps 10. Boathook clamp grips wires, lugs, terminals. Accepts banana plug or bare wire lead. 4 3/4" long. **\$1.19**
 - Kleps 20. Same, but 7" long. **\$1.39**
 - Kleps 30. Completely flexible. Forked-tongue gripper. Accepts banana plug or bare lead. 6" long. **\$1.47**
 - Kleps 40. Completely flexible. 3-segment automatic collet firmly grips wire ends, PC-board terminals, connector pins. Accepts banana plug or plain wire. 6 1/4" long. **\$2.39**
 - Kleps 1. Economy Kleps for light line work (not lab quality). Meshing claws. 4 1/2" long. **\$.99**
 - Prof 10. Versatile test prod. Solder connection. Molded phenolic. Doubles as scribing tool. "Bunch" pin fits banana jack. Phone tip. 5 1/2" long. **\$.79**
- All in red or black — specify. For additional information, write for complete catalog of — test probes, plugs, sockets, connectors, earphones, headsets, miniature components.

Available through your local distributor, or write to:



RYE INDUSTRIES INC.

128 Spencer Place, Mamaroneck, N.Y. 10543

In Canada: Rye Industries (Canada) Ltd.

Circle 79 on reader service card

next month

DECEMBER 1972

■ Now The Transistor Is 25

December 23 marks the 25th anniversary of the transistor. Here's a look at its short yet long, and very exciting history.

■ Build An IC Breadboard

More than just an easy way to interconnect components, this unit has a built-in power supply and clock generator to speed circuit development.

■ Evolution Of The Calculator

Calculators, it seems, have been around for quite some time. Here's an in-depth look at how man has progressed from counting on his fingers to electronic marvels that solve complex problems in fractions of a second.

■ Keyed Rainbow For Faster Troubleshooting

The lowdown on how to use a color-bar signal generator effectively inside a color TV chassis.

PLUS:

- Solid-State Design
- Step-By-Step TV Troubleshooting
- Service Clinic
- Appliance Clinic
- Equipment Reports

Circle 80 on reader service card →

DAMPER DIODES—RCA CTC22, 41, 42 AND 43

It is advisable to use two diodes in parallel when replacing the solid-state damper diodes in these chassis. (Note: The damper diodes are supplied by two sources. The black plastic barrel portion of one is slightly larger than the other. Always use two of the same configuration.)

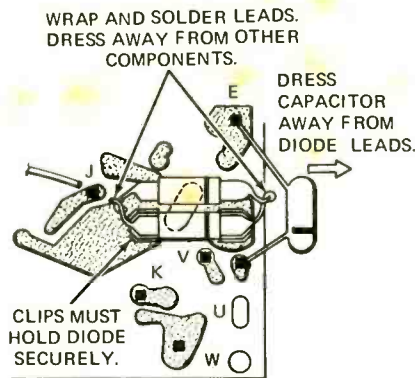

CTC 22

Two diodes, similar to those previously supplied except that they will have leads attached to each end, are available under stock number 135320. The single diodes without leads will not be available.

To install, wrap the diode leads together and solder. Make a good electrical and mechanical bond. Keep leads as short as possible, clip off excess. Space diodes approximately 1/8 inch apart for easier installation. Install the diodes as shown in the appropriate drawing.

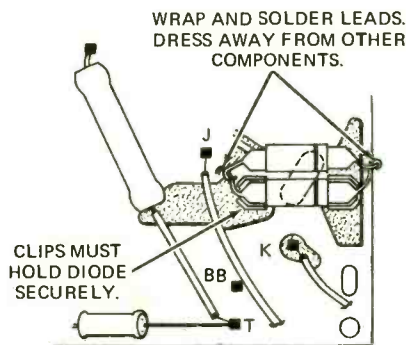

CTC 41, 42, 43

Caution: Relatively high voltages exist between the damper diode terminals and other components in the adjacent area. These components include capacitors, the metal chassis, board terminal stakes and associated leads and the printed circuitry on board PW400. Be sure the diode leads are dressed well away from these components. Make certain the mounting clips hold the diodes securely in position after dressing leads properly.—RCA Television Service Tips

MAGNAVOX T936 AND T956

Reduced vertical sweep may be a complaint on early production runs of these chassis. The +140-volt supply for the screen grid of the vertical output tube (V106) is developed from a voltage divider in the screen-grid circuit of the horizontal output tube (V103). In these chassis, leakage in diode

D102 (in the high-voltage regulator circuit) can cause increased screen current in the horizontal output stage, resulting in lower screen voltage and reduced vertical sweep.—Magnavox Service News Letter

MAGNAVOX T946

A condition of horizontal jitter in this chassis can be caused by leakage in capacitor C66—the .001- μ F, 1000-volt unit connected between terminal 4 on the flyback transformer and low end of the horizontal oscillator coil. The degree of jitter depends on the amount of leakage. Severe leakage through this capacitor can disable the horizontal oscillator and result in no high voltage.—Magnavox Service News Letter

SOUND DISTORTION ON CATV SYSTEMS

This complaint refers to G-E C2/L2 color chassis. The set performs normally on an outside antenna. On CATV, careful fine tuning will usually produce clear sound but use of afc will result in one or more stations with distorted sound.

The problem is caused by the cable sound-carrier levels being more than 17 dB below the video carrier (broadcast ratio is 10 dB). Sound sensitivity can be increased with a EP50X6 sound kit. Receivers beginning with serial numbers 5G40 . . . have the new circuit.—G-E Service Hints R-E

AT LAST! PROFESSIONAL HOME PROTECTION EVERYONE CAN INSTALL AND AFFORD.

Model FC-100
\$59.95
WIRED



- Start your custom Burglar/Hold-up/Fire Alarm System with the FC-100. Add on Sensors, Alarms and Accessories to suit your own needs.
- "Do-it-Yourself" Installers Handbook included. No technical knowledge needed — No soldering.
- 100% Professional in Design, Reliability, Performance.



'Fail Safe'-SYSTEM BY EICO

A New Concept in "Do-it-Yourself" Home Protection

FREE 32 PAGE EICO CATALOG

For latest catalog on EICO Test Instruments, Stereo, EICOCRAFT Projects, Environmental Lighting, Burglar/Fire Alarm Systems, and name of nearest EICO Distributor, check Reader Service Card or send 25¢ for First Class mail service.

EICO, 283 Malta Street, Brooklyn, N.Y. 11207



THE ONE WORD FOR PERFORMANCE AND RELIABILITY IN ELECTRONIC IGNITION

JUDSON

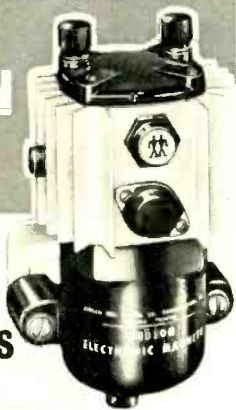

**YOU
CAN HAVE
TOMORROW'S
IGNITION ON
YOUR CAR TODAY**

Proven by over 100,000 in operation for over five years.

Don't accept "as good as" there are none.

Write Today for Literature



Circle 82 on reader service card

USING THE CURVE TRACER (continued from page 68)

the emitter circuit is proportional to the current flowing through it. This voltage is applied between the vertical input of the scope and ground. Hence the vertical deflection is proportional to the collector (and emitter) current.

On the 443, different circuits are used to accommodate pnp and npn transistors. The circuit in Fig. 7-a is used for a pnp device. Q1 and Q2, along with the associated circuitry, establish the steps for the base circuit in an interesting manner. Assuming the negative cosine wave of Fig. 7-b appears across the secondary of power transformer T1, the base of Q1 is negative with respect to the emitter for the first quarter cycle up to 90°. The transistor conducts and is in saturation. The collector of Q1 approaches the emitter voltage of the transistor. Meanwhile, the base of Q2 is negative with respect to its emitter, so that it does not conduct and its collector remains at the supply voltage potential. Resistors R48+R37 and R34+R33, connected to the collectors of Q1 and Q2 respectively are the components of a voltage divider. The voltage resulting from the divider action and from the relative voltages at the collectors of the

FIG. 8—CIRCUIT USED TO TEST POWER TRANSISTORS. The base current steps of Fig. 7 are amplified by transistors Q3 and Q4.

transistors, forms one step at the SIGNAL beta control. R47.

In passing, it should be noted that some JFET and IGFET characteristics can be tested on the 443. Once you know the current in milliamperes per step fed to the base, you can change the input steps into volts per step by merely adding a 1000-ohm resistor from the base to emitter terminal. The steps fed to the transistor are normal for the enhancement mode of operation and is quite satisfactory for most IGFET's. For JFET's, the bias should be in the reverse direction. However, it may be used in the direction supplied on the 443 for gate to source values up to 0.5 volts, if there is to be no conduction between the gate and source. The I_{DSS} will, of course, be the lowest step established when $V_{GS} = 0$. V_P can be determined from this curve. The ratio of the difference in drain current between the I_{DSS} step and the next step, to the difference in gate voltages establishing these steps, is the g_{m0} .

Extended use and imaginative applications are not limited to the engineers. Technicians can use any ac transistor tester to check transistors in (continued on page 98)

BUYING DAYS ARE HERE AGAIN

FREE \$1 BUY WITH EVERY 10 YOU ORDER

Only applies to "\$1" Buys

FREE GIFT WITH EVERY ORDER

- KNOB SPECIAL**
- 100 — ASSORTED RADIO KNOBS All standard types ... \$1
 - \$20 value
 - 50 — TV KNOBS — POPULAR TYPES Mostly Selector & Fine Tuning ... \$1
 - 25 — VERTICAL LINEARITY KNOBS Long shank ... Front mount ... miniature assortment ... \$1
 - 20 — VERTICAL LINEARITY KNOBS Side mount ... Standard sizes ... \$1
 - 25—KNURLED RADIO KNOBS Hard to get ... Best selection
 - 40 — DELUXE RADIO KNOBS Choice assortment ... Popular types ... \$1

ANY 6 KITS FOR \$5

- TRANSISTOR RADIO *asst type* \$1.50 good, bad, broken, as-is, potluck
- TAPE RECORDER—assorted types good, bad, broken, as-is, potluck ... \$4
- 300 — ASST. 1/2 W RESISTORS Top Brand, Short Leads, Excellent Selection ... \$1
- 100—ASST 1/4 WATT RESISTORS stand, choice ohmages, some in 5% ... \$1
- 100—ASST 1/2 WATT RESISTORS stand, choice ohmages, some in 5% ... \$1
- 70 — ASST 1 WATT RESISTORS stand, choice ohmages, some in 5% ... \$1
- 35 — ASST 2 WATT RESISTORS stand, choice ohmages, some in 5% ... \$1
- 50 — PRECISION RESISTORS *asst. list-price \$50 less 98%* ... \$1
- 20 — ASSORTED WIREWOUND RESISTORS, 5, 10, 20 watt ... \$1
- 10—ASSORTED SLIDE SWITCHES SPST, SPDT, DPDT, etc. ... \$1

- COLOR POWER TRANSFORMER — Good for most sets 26R150 \$6.95 List Price—\$36.75
- 4—50' HANKS HOOK-UP WIRE \$1 assorted colors
- 100'—SPOOL SPEAKER WIRE \$1.50 2 cond, mini zip, clear, 101 uses
- 10 — ASST. RADIO & TV TUBES \$1 Every Tube a good number
- 5 — I.F. COIL TRANSFORMERS \$1 456-kc for Transistor Radios
- 6" UNIVERSAL SPEAKER Top quality Special buy \$1.29 Ea. 5 for \$5
- 12" UNIVERSAL SPEAKER \$4.89 Top Quality ... Large Magnet
- 10" PHILCO SPEAKER \$2.99 Top Quality ... Large Magnet
- 8" UNIVERSAL SPEAKER — \$2.99 Large Magnet—Special Buy
- 5" UNIVERSAL TWEETER \$1.29 1 Oz. Magnet
- UNIVERSAL 4" PM SPEAKER \$1 Top Quality
- 2 1/2" x 4" SPEAKER \$69¢ Ea. Special Buy 10 For \$5—
- 3 1/2" — ROUND SPEAKER \$59¢ Special Buy
- 4" X 6" "QUAM" 16 OHM SPEAKER Large magnet ... \$1.79 Special BUY (10 for \$15.00)
- RONETTE STEREO CARTRIDGE \$2 latest dual sapphire slipover type
- STEREO HEADPHONES HI-FI Quality ... Complete with Stereo plug ... \$5.95
- UHF OR VHF MATCHING TRANSFORMER Simple Fool-proof installation ... \$1
- ALL AMERICAN TUBE KIT (12AV6-12BE6-12BA6-35W4-50C5) ... \$2.99

- 2 — COLORBURST QUARTZ-CRYSTAL For Most Color TV sets 3579.545 KC ... \$1.89
- 2 — ELECTROLYTIC CAPACITORS CD — 40/40 MFD — 450 Volts ... \$1
- SPECIAL TUBE BUY 4 — 18Y6 American made ... \$1
- 1—6" x 9" HEAVY DUTY 10 OZ. SPEAKER Ceramic Type ... \$3.69 8 Ohm
- 5 ASST. GLOBAR VARISISTOR Popular replacements for most COLOR TV ... \$1
- 10 — SETS PHONO PLUGS & PIN JACKS RCA type ... \$1
- 5—PRINTED CIRCUIT IF TRANSFORMERS 4-Lug, 456 KC ... \$1
- 25 — 3900-OHM-7w RESISTOR 10% Corning glass ... \$1
- 20 — 47-600V CONDENSERS White Ceramic C.D.—American ... \$1
- 13 Pc. SCREWDRIVER & \$5.95 NUTDRIVER SET reg \$8.95
- CO-AX CABLE RG59U grey or black 250'—\$9 100'—\$3.69 50'—\$2
- 4 — TV ALIGNMENT TOOLS \$1 most useful assortment #1
- 4 — TV ALIGNMENT TOOLS \$1.49 For Color TV #2
- 6 — TV COLOR ALIGNMENT \$2.79 TOOLS Most popular type
- 4 — 9 VOLT MOTORS Excellent for hobbyist ... \$1
- 200'—#24 SOLID PUSH BACK WIRE Yellow or Black excellent buy ... \$1
- UNIVERSAL TV ANTENNA Back of set mounting ... \$1.98 5 section rods

SARKES TARZIAN TUNER
41mc

Latest Compact Model good for all 41 mc TV's.
BRAND NEW—

Best TUNER "SARKES TARZIAN" ever made—last word for stability, definition & smoothness of operation. An opportunity—to improve and bring your TV Receiver up-to-date.
\$7.95
COMPLETE with Tubes

- UHF TUNER — TRANSISTOR TYPE Used in all TV sets ... \$3.95
- STANDARD TUNER — TRANSISTOR (GUIDED GRID) 4 Channel closed circuit ... \$1
- PHILCO TV TUNERS Model — 76-13379-8 (5GJ7—3HQ5) ... \$4.95
- GE — TV TUNERS Model-ET 86X314 — (5LJ8-3GK5) ... \$5.95
- GE — STANDARD COIL TV TUNER Model EU-S6XI (6HQ5—6GJ7) Model-ET 86X304 — (6LJ8—6HA5) ... \$7.95
- TV TUNERS VHF/UHF all new standard makes, including Tubes ... \$7.95
- ALL NEW TV TUNER Standard makes — less tubes ... \$1

IMMEDIATE DELIVERY ... Scientific light packing for safe delivery at minimum cost. **HANDY WAY TO ORDER:** Pencil mark or write amounts wanted in each box, place letter F in box for Free \$1 BUY. Enclose with check or money order, add extra for shipping. Tear sheets will be returned as packing slips in your order, plus lists of new offers. **Minimum Order \$3.00**

Please specify refund on shipping overpayment desired: CHECK POSTAGE STAMPS MERCHANDISE (our choice) with advantage to customer

BROOKS RADIO & TV CORP., 487 Columbus Ave., New York, N. Y. 10024 212-874 5600 TELEPHONE

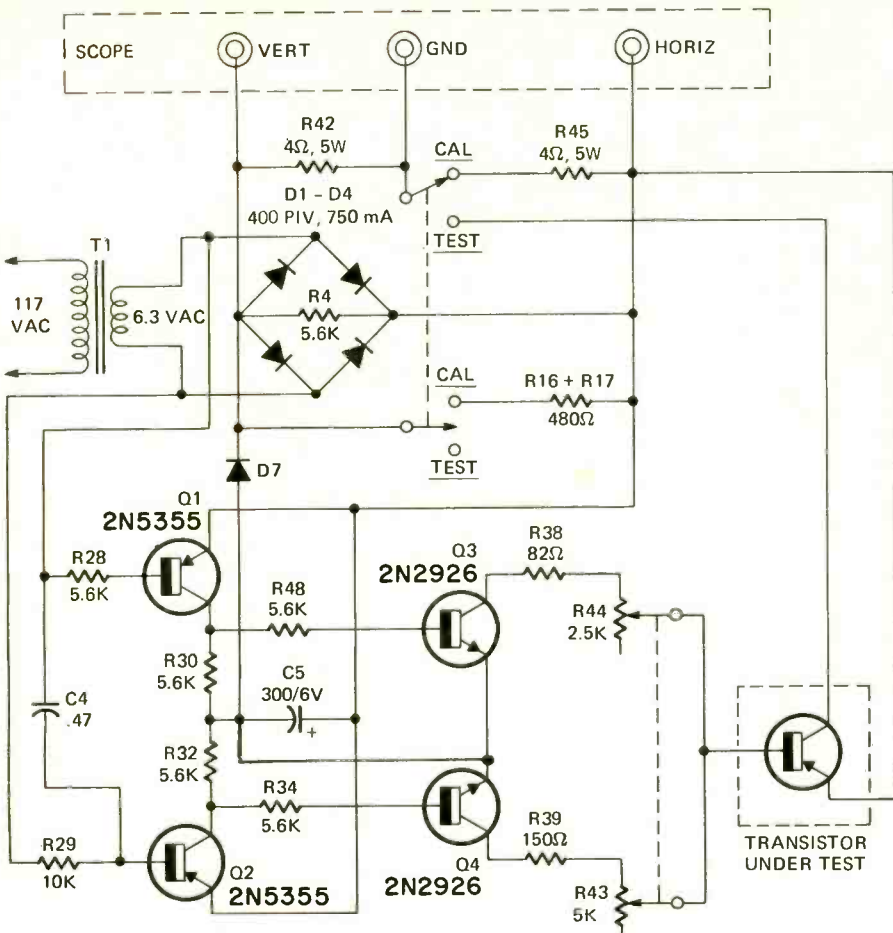

NEW LOW PRICED DIGITAL CLOCK KITS

(12 OR 24 HOUR)

Easy reading 7 segment display tubes. Solid state components. Printed circuit. Accurate 60 cycle line, time reference. Simple, push button settings. Displays hours, minutes and seconds. Easy step by step instructions.

USE YOUR MASTER CHARGE OR BANKAMERICARD

Kit price: \$64.50 Choice of cases extra: Metal - \$10 / Walnut - \$15 Calif. residents add 5% tax.

Order or write Money back guarantee.
for details:

Dept. R 11
ESTERPRISES
506 Main St. • El Segundo,
Calif. 90245 • (213) 772-6176

Circle 83 on reader service card

CANADIANS: Ordering is easy — we do the paperwork — try a small order

IBM COMPUTER SECTIONS
8 assorted Units we sell for \$1 are loaded with over 150 valuable parts.
Incl. — Transistors, Condensers, Resistors, Heat Sinks, Diodes, Etc.

8 for \$1
100 for \$10

WESTINGHOUSE ALL TRANSISTOR HOME/OFFICE MESSAGE CENTER

Leaves messages for other for replay . . . Built in speaker/microphone for talk-into convenience . . . Records up to 3 minutes of messages . . . Illuminated signal shows when a message is waiting. Control adjusts playback volume without affecting recording volume . . . Capstan Drive;
BRAND NEW SOLD AS IS \$7.95

SHANNON MYLAR RECORDING TAPE

2 1/2" — 225' .. \$.17	7" — 2400'	\$1.79
3" — 225' .. .19	7" — 3600'	2.95
3" — 300' .. .27	CASSETTE C-6059
3 1/4" — 600' .. .58	CASSETTE C-90	1.00
5" — 600' .. .62	CASSETTE C-120 (TDK) ..	1.97
5" — 900' .. .80	2 1/2" TAPE REEL05
5" — 1200' .. .97	3" TAPE REEL06
5" — 1800' .. 1.49	3 1/4" TAPE REEL07
7" — 1200' .. .77	5" TAPE REEL14
7" — 1800' .. 1.12	7" TAPE REEL15

- WESTINGHOUSE FM TUNER (12DT8 Tube)
- WESTINGHOUSE FM TUNER #476-V-015D01 . . . Transistor
- 300 — ASSORTED HEX NUTS 2/56, 4/40, 5/40, 6/32, 8/32 ..
- 250 — ASST. SOLDERING LUGS best types and sizes
- 250 — ASST. WOOD SCREWS finest popular selection
- 250 — ASST. SELF TAPPING SCREWS #6, #8, etc.
- 150 — ASST. 6/32 SCREWS and 150 6/32 HEX NUTS
- 150 — ASST. 8/32 SCREWS and 150—8/32 HEX NUTS
- 150 — ASST. 2/56 SCREWS and 150—2/56 HEX NUTS
- 150 — ASST. 4/40 SCREWS and 150—4/40 HEX NUTS
- 150 — ASST. 5/40 SCREWS and 150—5/40 HEX NUTS
- 500 — ASSORTED RIVETS most useful selected sizes
- 500 — ASSORTED WASHERS most useful selected sizes
- 100 — ASST. RUBBER BUMPERS for cabinet bottoms & other uses ..
- 100—ASSORTED RUBBER GROMMETS best sizes

RCA 110° FLYBACK TRANSFORMER

We scooped the Market Latest type — standard for all 110° TV's
RCA's design of large Coil produces 18KV—assuring adequate width Incl Schematic Diagram application for any TV
List price \$13.90
Your price **\$3**
10% off in lots of 3

- 110° TV DEFLECTION YOKE for all types TV's Incl schematic
- "COMBINATION SPECIAL" RCA 110° FLYBACK plus 110° DEFLECTION YOKE
- 90° FLYBACK TRANSFORMER for all type TV's Incl schematic
- 90° TV DEFLECTION YOKE for all type TV's Incl schematic
- 70° FLYBACK TRANSFORMER for all type TV's Incl schematic ..
- 70° TV DEFLECTION YOKE for all type TV's Incl schematic ..
- 2 — TV CIRCUIT BREAKERS Rated 4.2 TO 5.0 AMPS, etc.
- 90° COLOR YOKE For all Rectangular 19 to 23" Color CRT's ..
- RCA COLOR FLYBACK Part #113382 (Stancor #E0-601C) ..

- COLOR-TV RECTIFIER — Used in most color sets— 6500 kv
- 10 — STANDARD TRANSISTORS NPN & PNP 2N404, 2N414, etc. ...
- 10—ASSORTED DIODE CRYSTALS 1N34, 1N48, 1N60, 1N64, etc. ...
- 6 — TOP BRAND SILICON RECTIFIERS 1 amp, 1000 PIV
- 5 — PNP TRANSISTOR general purpose, TO-5 case
- 5 — NPN TRANSISTORS general purpose, TO-5 case
- 50 — ASSORTED TRANSISTORS big factory scoop—sold as-is
- TV TWIN LEAD-IN 300 ohm 500' — \$7 100'—\$1.50 50'—
- 12—MINIATURE ELECTROLYTIC CONDENSERS For Transistor & miniature work
- 6 — MINIATURE ELECTROLYTIC CAPACITORS 5 MFD—150 V. ...
- 3—ELECTROLYTIC CONDENSERS 100 mfd.—100 V, 50 mfd.—75 V. ...
- 2—ELECTROLYTIC CONDENSERS C.D. 500 mfd.—200 volts
- 2—ELECTROLYTIC CONDENSERS UNECAP ..2000/1000 Mfd 30 Volt
- 2 — ELECTROLYTIC CONDENSERS 80/50mfd.450V, 20mfd-250V, 150mfd-25V
- 2 — ELECTROLYTIC CONDENSERS 200/30/4 mfd — 350V
- COLOR CONVERGENCE ASSEMBLY Universal type— good for most sets

MARKET SCOOP COLUMN

- ASTATIC PICKUP MODEL 700-89T Contains 89T ceramic cartridge LIST PRICE \$17.00 ..
- BLANK 8 TK CART. TAPE 64 Minutes \$1 80 Minutes \$1.39
- 70° COLOR TUBE BRIGHTNER \$3.95
- 90° COLOR TUBE BRIGHTNER \$4.95
- HEAVY DUTY COLOR FOCUS RECTIFIER 14,000 PIV @ 1 ma ..
- STEREO TONE ARMS Most popular type—turn over cartridge ..
- PENCIL TYPE SOLDERING IRON Lightweight 30 watt Iron —UL Approved
- 20 — DIPPED MYLAR CAPACITORS .01—600V
- 20 — DIPPED MYLAR CAPACITORS .033—600V
- 20 — DIPPED MYLAR CAPACITORS .0033—1000 V
- 20 — DIPPED MYLAR CAPACITORS .047—400 V.
- 15 — MOLDED TUBULAR CAPACITORS .088—400 v.
- 20 — DIPPED MYLAR CONDENSERS .0039—400 V.
- 10 — SPRAGUE "ORANGE DROP" CAPACITORS .0056—2000 Volt
- 1 — 20 FT. COILED GUITAR CABLE With plugs
- 1—CASSETTE TYPE DYNAMIC MICROPHONE with universal plugs—200 Ohms

Circle 84 on reader service card

DISCOUNT PRICES TEST EQUIPMENT



SENCORE

Test Equipment of Other
Manufacturers also Available

Shure and Electro-Voice
Microphones

I.E.C./Mullard
Tube Specials

Catalog & Prices on Request

FORDHAM Radio Supply
Company, Inc.



265 E. 149 Street, Bronx, N.Y.
Tel: (212) 585-0330



DISTRIBUTORS OF ELECTRONIC SUPPLIES

Circle 85 on reader service card

HARD-TO-FIND TOOLS

FOR ELECTRONICS AND FINE MECHANICS



Free Catalog →

Includes 72 pages of hard-to-find tools
used by electronic technicians, instru-
ment mechanics, engineers, scientists.
Over 1700 items listed. Write today.



JENSEN TOOLS and ALLOYS
4117 N. 44TH STREET, PHOENIX, ARIZONA 85018

Circle 86 on reader service card

USING THE CURVE TRACER

(continued from page 97)

circuit. The curve tracer is an ac transis-
tor tester. To be sure, the curves will not
be as logical nor as valuable as when
the transistor is tested out of circuit, but,
in some distorted manner, these tests
will show four steps and indicate that
there is gain if the transistor is not defec-
tive. A shorted transistor will appear
as a single vertical line on the 'scope
while an open transistor will appear as a
single horizontal line.

The circuit in Fig. 7-a does not sup-
ply enough base drive to accommodate
a power transistor. A position on the
FUNCTION switch is provided for this
type of device. In the 443, two transis-
tors are added to the collector circuits or
Q1 and Q2. They increase the current at
the collectors enough to drive the base
of a power transistor. The circuit is
shown in Fig. 8. The performance is ex-
actly as discussed above for the signal
device, except that now, the POWER dial
must be used for beta measurements. It
is accurately calibrated in beta when the
maximum collector current step is at 1
ampere. All suggestions listed for di-
verse tests in the signal transistor dis-
cussion can be applied here as well. I
am certain you will find a few more!

Only a curve tracer will provide re-
verse characteristic information about a
diode economically. The 443 will test
the breakdown of rectifiers up to 2000
volts and show leakage current down to
1 mA per division. A protection switch
and flashing warning light are provided
on the front panel to alert the user that
high voltages are present.

The forward and reverse break-
down voltages of SCR's can likewise be
tested. Connect a 1000-ohm resistor
from the gate to the cathode and con-
nect the cathode and anode to the tester
as you would an ordinary diode. Ad-
vance the VOLTAGE ADJUST control and
note the reverse breakdown voltage of
the SCR. The forward breakdown vol-
tage can be measured by simply revers-
ing the connections of the SCR to the
tester. The holding current can likewise
be observed in this test.

The 443 must be connected to a
scope to observe the various displays.
Inexpensive scopes using ac amplifiers
are perfectly satisfactory. However, due
to capacitive coupling, you will find it
necessary to reset the vertical and hori-
zontal controls for many of the mea-
surements. In addition there will not be
a true dc level so that you will be unable
to note leakage current on the set of col-
lector curves. You will, however, be
able to measure it quite accurately using
the reverse diode test position.

The best solution is obvious. Use a
scope with horizontal and vertical dc
amplifiers.

R-E

SPECIAL OFFER

NOW YOU CAN GET THESE TWO TV TECH AID BOOKS AT REDUCED
PRICES:

1971 B&W BOOK — NOW \$4.95

1970-BOOK FORM — NOW \$4.95

TV TECH AID BOOKS ARE FILLED WITH THE LATEST QUICK-SERVICING
INFO ON COLOR TV, B&W TV, AND STEREO . . .

TV Tech Aid Takes you right to the source of the trouble without guess
work and wasted time. In each monthly issue you receive over 40 actual
causes and cures of color and B&W TV trouble symptoms. You also
receive timely and complete information about circuit modifications and
other valuable service data.

USE THE COUPON BELOW TO PLACE YOUR 1972
SUBSCRIPTION (12 ISSUES \$7.95) OR VALUABLE BACK ISSUES

SEND YOUR CHECK
OR MONEY ORDER
TO:

TV TECH AID

P. O. Box 603
Kings Park
N.Y. 11754

- 1969 12 Issues \$4.95 1970-Book Form \$4.95
 1971 B&W Book \$4.95 1971 12 Issues \$7.95
 1972 All New 12 Issues \$7.95

Name.....

Address.....

City.....

State..... Zip.....

Circle 87 on reader service card

SPECTACULAR!! PRICE WAR ON SURPLUS SEMICONDUCTORS

LINEAR DEVICES, OP AMPS, REGULATORS

- 709 High performance Op-Amp \$5.00
- 711 Dual Comparator \$5.00
- 723 Regulator \$1.25
- 741 Compensated Op-Amp \$5.00
- 558 Dual 741 \$1.00
- LM309 5 Volt 1 amp Regulator, TO-3 \$2.25

FAIRCHILD VOLTAGE REGULATOR



Fairchild UGH7805 5 Volt 1 amp voltage regulator. Perfect for logic supplies, very compact \$1.95

SPECIAL I.C.'S, PHASE LOCKED LOOPS

- NE560 Phase Locked Loop \$4.65
- NE561 Phase Locked Loop \$4.65
- NE562 Phase Locked Loop \$4.65
- NE565 Phase Locked Loop \$4.65
- NE566 Function Generator/Tone Encoder \$4.65
- NE567 PLL/Tone Decoder \$4.65
- NE595 Four Quadrant Multiplier \$3.75
- NE555 Timer, 2u Sec to 1 hour, Special \$1.25
- NE540 Power Driver, for 100w AB amp \$2.25

MEMORIES, SHIFT REGISTERS, ROM'S

- 1101 256 Bit RAM, MOS \$4.00
- 1103 1024 Bit RAM, MOS \$8.75
- 7489 64 Bit RAM, TTL \$3.75
- 2513 Character Generator ROM \$14.75
- 1402 Shift Register \$4.00
- 1403 Shift Register \$4.00
- 1404 Shift Register \$4.00
- 8224 Programmable ROM \$14.75

Dear Customers,

We want to take this opportunity to thank you for your patronage. Your response, has in a few short years allowed us to grow to become one of the largest surplus dealers in the U.S., and because of our buying power, we are able to offer you "state of the art" components at prices the hobbyist can afford. Offering the latest technology though, has its pitfalls. Sometimes manufacturers, promising us the latest in LED's, MSI, or other advanced technology, have had problems getting their production lines going and have delayed shipment to us which resulted in a delay to you. We hope you will understand this at these times and accept our apologies.

In order to offer you still better service in the future, we have made some significant changes here at B & F. We have formed a joint venture with Arles Inc. to develop, manufacture and market kits only. (You will find their ad elsewhere in this magazine). The engineering staff represents some of the finest engineering talent in the United States, even if we say it ourselves. The division leaves us free to pursue the surplus business and to devote our full time to servicing your orders and finding new "buys".

We also have increased our staff and can now offer more service on information requests. Please keep them simple, however, as we can not do the engineering for you, but will do all within our power to provide you with complete data on everything we sell.

Thank you again, and we look forward to many more years of offering you the latest in electronics and electro-optical technology.

Very truly yours,

Franklin G. Fink
Peter E. Boniface

Franklin G. Fink
Peter E. Boniface
Partners - B & F Enterprises

HIGH POWER SCR'S



SCR's - invaluable for high power applications, motor speed controls, lighting circuits, welding controls, etc. Never before at this low price. Brand new packaged devices, complete with data sheet and 24 page consumer applications manual.

- 2N5062 Plastic 100V 1 amp \$3.35
- 2N5064 Plastic 200V 1 amp40
- 2N4169 100V/8 amp stud 1.45
- 2N4170 200V/8 amp stud 1.65
- 2N4172 400V/8 amp stud 1.95
- 2N3525 400V/3 amp press fit95
- 2N1772/C15A 100V/8 amp stud 1.75
- 2N1774/C15B 200V/8 amp stud 1.95
- 2N1777/C15D 400V/8 amp stud 2.50
- 2N1844/C20A 100V/12 amp stud 1.75
- 2N1846/C20B 200V/12 amp stud 1.95
- 2N5169 200V/20 amp stud 3.75
- 2N5170 500V/20 amp stud 4.75
- 2N5171 700V/20 amp stud 6.75
- 2N3896/C30A 100V/25 amp stud 2.95
- 2N3897/C30B 200V/25 amp stud 3.95
- 2N3899/C30E 500V/25 amp stud 4.95



CALCULATOR CHIP SPECIAL

B and F has purchased a quantity of MOS large scale integration chips for calculators. We are not allowed to mention the manufacturers name, however, the specs should make them self-evident.

- Set "X" - Four 24 pin I.C.'s, BCD output, 16 digit, fixed automatic decimal point, possible memory expansion, constant \$29.00
- Set "Y" - Single 40 pin, 7 segment output, 12 digit, fixed automatic decimal, no constant \$15.00
- Set "Z" - Single 40 pin I.C., 7 segment output, 8 digit, floating point, constant \$19.50

7400 SERIES TTL SUMMER CLEARANCE MOST POPULAR I.C. SERIES MADE !!!!!

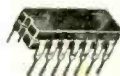

B and F maintains an inventory of over one million brand new, factory packaged integrated circuits, and is continually buying more from sources throughout the country. We intend to offer these at the lowest prices of any supplier, and to prove this point we have just cut our own normally fantastic low prices even lower. We will meet or better any 7400 series price. Data sheets are included with all items. On orders over \$20.00 we will include free, a TTL data book or Linear data book, totaling over 200 pages. Orders over \$100.00 will receive a 1000 page data file. An additional discount of 5% will be allowed for orders over \$250.00 and 10% for orders over \$1000.00.

- | | | |
|---------------|---------------|----------------|
| □ 7400 - .22 | □ 7451 - .22 | □ 74150 - 1.55 |
| □ 7401 - .22 | □ 7453 - .22 | □ 74151 - 1.13 |
| □ 7402 - .22 | □ 7454 - .22 | □ 74153 - 1.55 |
| □ 7403 - .22 | □ 7460 - .22 | □ 74154 - 2.30 |
| □ 7404 - .27 | □ 7470 - .40 | □ 74155 - 1.39 |
| □ 7405 - .27 | □ 7472 - .36 | □ 74156 - 1.39 |
| □ 7406 - .50 | □ 7473 - .48 | □ 74157 - 1.48 |
| □ 7407 - .50 | □ 7474 - .48 | □ 74158 - 1.48 |
| □ 7408 - .30 | □ 7475 - .76 | □ 74160 - 1.79 |
| □ 7409 - .30 | □ 7476 - .53 | □ 74161 - 1.79 |
| □ 7410 - .22 | □ 7480 - .72 | □ 74162 - 1.79 |
| □ 7411 - .27 | □ 7481 - 2.45 | □ 74163 - 1.79 |
| □ 7413 - .55 | □ 7482 - 2.45 | □ 74164 - 3.75 |
| □ 7416 - .50 | □ 7483 - 1.55 | □ 74165 - 3.75 |
| □ 7417 - .50 | □ 7485 - 2.45 | □ 74166 - 3.75 |
| □ 7420 - .22 | □ 7486 - .55 | □ 74167 - 4.75 |
| □ 7421 - .22 | □ 7489 - 4.00 | □ 74170 - 5.75 |
| □ 7426 - .32 | □ 7490 - .76 | □ 74180 - 1.13 |
| □ 7430 - .22 | □ 7491 - 1.35 | □ 74181 - 4.90 |
| □ 7437 - .53 | □ 7492 - .76 | □ 74182 - 1.13 |
| □ 7438 - .53 | □ 7493 - .76 | □ 74184 - 2.95 |
| □ 7440 - .22 | □ 7494 - 1.12 | □ 74185 - 2.95 |
| □ 7441 - 1.64 | □ 7495 - 1.12 | □ 74190 - 2.95 |
| □ 7442 - 1.21 | □ 7496 - 1.12 | □ 74191 - 2.45 |
| □ 7443 - 1.21 | 74100 - 1.44 | □ 74192 - 1.87 |
| □ 7444 - 1.21 | 74107 - .49 | □ 74193 - 1.87 |
| □ 7445 - 1.62 | 74121 - .53 | □ 74194 - 2.95 |
| □ 7446 - 1.17 | 74122 - .67 | □ 74195 - 1.95 |
| □ 7447 - 1.10 | 74123 - 1.06 | □ 74198 - 2.65 |
| □ 7448 - 1.37 | 74141 - 1.55 | □ 74199 - 2.65 |
| □ 7450 - .22 | 74145 - 1.33 | |

FLAT NYLON LACING TAPE

One pound tube of black lacing, about 1,000 yards, should last the average hobbyist several years. Usual price is \$10.50. At this price you can use it for all kinds of applications besides lacing. Test over 50 lbs.
□ Lacing Cord 1 lb. \$2.00

SANKEN HIGH POWER, HIGH PERFORMANCE HYBRID VOLTAGE REGULATORS

These hybrid regulators are easy to use, requiring no external components. Excellent for operational amplifier supplies, logic supplies and other high performance applications. All regulators have less than 50 millivolts ripple and better than 1% line and load regulation, some models far exceeding this specification.

- SI3120E 12 Volts, 1 Ampere \$2.25
- SI3150E 15 Volts, 1 Ampere \$2.25
- SI3240E 24 Volts, 1 Ampere \$2.25
- SI3050E 5 Volts, 1 Ampere \$2.25
- SI3554M 5 Volts, 3 Amperes \$7.00

SANKEN HYBRID AUDIO AMPLIFIER MODULES



We have made a fortunate purchase of Sanken Audio Amplifier Hybrid Modules. With these you can build your own audio amplifiers at less than the price of discrete components. Just add a power supply, and a chassis to act as a heat sink. Brand new units, in original boxes, guaranteed by B and F, Sanken and the Sanken U.S. distributor. Available in three sizes: 10 watts RMS (20 watts music power), 25 watts RMS (50 watts M.P.) and 50 watts RMS (100 watts M.P.) per channel. 20 page manufacturers instruction book included. Sanken amplifiers have proved so simple and reliable, that they are being used for industrial applications, such as servo amplifiers and wide band laboratory amplifiers.

- SI1010Y 10 watt RMS amplifier, industrial grade \$4.75
- SI1025A 25 watt RMS amplifier, industrial grade \$14.75
- SI1050A 50 watt RMS amplifier, industrial grade \$22.50
- SI1025E 25 watt RMS amplifier, entertainment grade \$14.00
- SI1050E 50 watt RMS amplifier, entertainment grade \$21.00
- Transformer for stereo 10 watt amplifiers (2 lbs.) \$3.95
- Transformer for stereo 25 or 50 watt amplifiers (5 lbs.) \$5.95
- Set of (3) 2000 mfd 50V capacitors for 10 watt stereo \$4.00
- Set of (3) 2200 mfd 75V capacitors for 25 or 50 watt amplifiers \$5.00
- 4 Amp Bridge Rectifier, suitable for all amplifiers \$2.00
- Complete kit for 100 watt RMS stereo amplifier (200 watt music) including two 50 watt Sanken hybrids, all parts, instructions, and nice 1/16" thick black anodized and punched chassis \$88.00
- Same for 50 watt RMS stereo amplifier, includes two 25 watt Sankens, etc. \$58.00
- Same for 20 watt RMS stereo, includes two 10 watt Sankens, etc. \$30.00

SGS TAA 621 AUDIO AMPLIFIER

□ I.C. audio amplifier in 14 pin DIP package, provides up to 4 watts power with proper heat sink, and 28 Volt supply. Can be used at 12 Volts with reduced output power. - \$1.95 6 for \$10.00



COMPLETE WITH CARRYING CASE AC/DC TYPE

UNBELIEVABLE? A COMPLETE POCKET CALCULATOR FOR ONLY \$99.00

We are closing out some demonstrator Sanyo pocket calculators for only \$99.00. This is a complete unit with nickel cadmium battery. Has eight digit LED display, with sixteen digit capability. Fixed automatic decimal at 0, 2, or 4 places. Units are demonstrators, but are in original factory cartons with guarantee cards, instructions, etc. Carries full one year factory guarantee by Sanyo. Only 35 available so order now.
□ Sanyo Pocket Calculator \$99.00
□ AC Power Pack/Recharger \$19.00

ALL ITEMS WHERE WEIGHT NOT SPECIFIED POSTAGE PAID IN THE U. S. A.

Phone in charges to (617) 531-5774 or (617) 532-2323. BankAmericard - Mastercharge. \$10.00 minimum. No C.O.D.'s please.



\$10.00 Minimum Charge



B. & F. ENTERPRISES

Phone (617) 532-2323
P.O. Box 44, Hathorne, Massachusetts 01937



SAVE MONEY!

A Delta Mark Ten Capacitive Discharge Ignition (CDI) System On Your Car Slashes Maintenance Costs And Increases Performance.

Put a Mark Ten on your car and save by eliminating 3 out of 4 tune-ups. Save as gasoline mileage increases (up to 20%). The Mark Ten CDI System also extends spark plug life, promotes more complete combustion and assures instant starts in all weather. It operates on any 6 or 12 volt negative or positive ground system.

The Mark Ten B affords additional money saving advantages by drastically reducing combustion contaminants and restoring power lost by the use of smog control devices. Equipped with handy switch for instant return to standard ignition, the Mark Ten B works with ANY 12 volt negative ground engine. Both systems install in ten minutes without rewiring.

Order your Mark Ten or Mark Ten B today. Save money while you enjoy low maintenance and increased performance.

Mark Ten (Assembled) \$44.95 ppd.

Mark Ten (Deltakit) \$29.95 ppd.

(Kits available in 12 volt only, positive or negative ground)

Mark Ten B \$59.95 ppd.

(12 volt negative ground only)

Superior Products at Sensible Prices
Mfg. in U.S.A.



Dept. RE
DELTA PRODUCTS, INC.

P.O. BOX 1147 • GRAND JUNCTION, COLORADO 81501
PHONE: (303) 242-9000

Please send me literature immediately:

Enclosed is \$ _____

Ship ppd. Ship C.O.D.

Please send: _____ Mark Ten B @ \$59.95 ppd.

_____ Standard Mark Ten (Assembled) @ \$44.95 ppd.

_____ 6 Volt: Neg. Ground Only _____ Positive Ground

_____ 12 Volt: Specify _____ Negative Ground

_____ Standard Mark Ten (Deltakit®) @ \$29.95 ppd.

(12 Volt Positive Or Negative Ground Only)

Car Year _____ Make _____

Name _____

Address _____

City/State _____ Zip _____

Circle 89 on reader service card

100 RADIO-ELECTRONICS • NOVEMBER 1972

circuits

A SIMPLE ALARM

Need a simple alarm? A 3pst relay with normal open contacts will solve the problem. From the schematic, once triggered the alarm sensor and on/off switch are bypassed. The on/off switch is a toggle switch, thus saving the extra cost of a key operated switch. For optimum protection, it is suggested that the power source be wired direct to line, thereby eliminating an obvious line cord. For the same reason, the alarm

OPERATING
VOLTAGE
INPUT

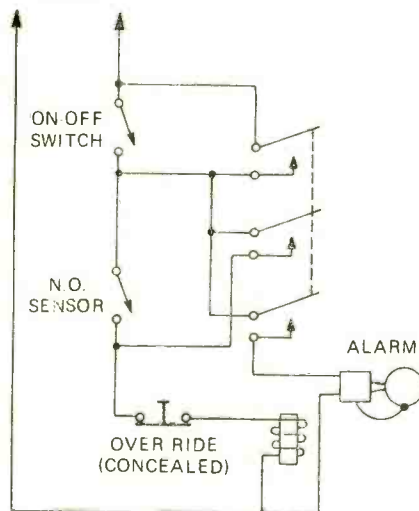

should be attached to the same box as the relay. With this scheme, the only visible wire would be the alarm sensor and by the time an intruder noticed this wire, the alarm would be on and an attempt to cut this wire would end in negative results. The concealed over-ride switch is a major feature of this system. The ingenuity of the constructor will dictate type and access to this switch.

A form of self test can be performed by operating the alarm sensor, a test for power as well as component failure. In addition, relay life should be optimum. —Herbert C. Olney R-E

GUARD THOSE YOU LOVE



**GIVE TO THE
AMERICAN
CANCER
SOCIETY**

FREE OFFER FROM VERO

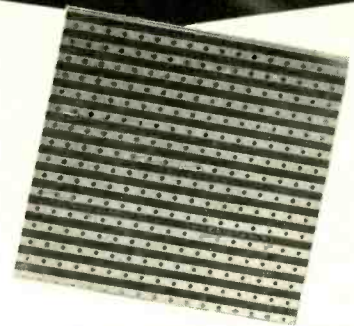

In order to acquaint you with our unique, universal wiring board, we'd like to send you a sample . . . free of charge. You'll find it a great time-saver in circuit construction and it eliminates the need for etching, drilling and tools. Send for your free sample today . . . You'll be glad you did.



VERO ELECTRONICS Inc.

171 Bridge Road

Hauppauge, N.Y. 11787

Circle 90 on reader service card

Draw the line on contact failure...



with an **Electrolube pen.**

A newly developed contact treatment that:

- Prevents tarnishing
- Inhibits arcing
- Reduces contact resistance
- Improves reliability

Special introductory coupon offer. Regular \$2.50

**Electrolube pen
only \$1.95.**

Electrolube Corporation
155 Michael Drive
Syosset, N.Y. 11791

Please send me one Electrolube pen.
I enclose \$1.95.

Name _____
Address _____
City _____ State _____ Zip _____

Circle 91 on reader service card

ARIES

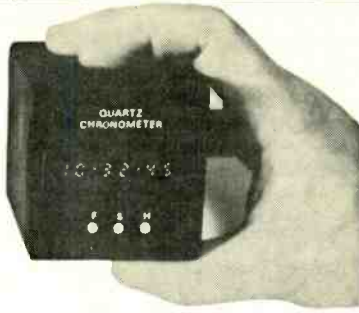

AIRCRAFT/AUTO/BOAT QUARTZ CRYSTAL CHRONOMETER

Revolutionary! was the reaction of our customers when they saw our latest kit. Measuring only 2-1/2" x 2-1/2" x 4", and accurate to 10 seconds a month, this chronometer promises to entirely replace mechanical clocks in cars, boats and airplanes.

Fits into a standard 2-1/4" instrument panel cutout. The displays are bright L.E.D. displays that should last a lifetime. Setting controls are recessed and operate from a pointed object such as a pencil point or paper clip, in order to keep non-authorized hands off. The clock should only have to be reset at very great intervals, or in the event of power loss (i.e. replacing battery in car). The clock is wired so that the timing circuits are always running, but the displays are only lit when the ignition is on, resulting in negligible power drain. The low price is only possible because of a new one chip MOS clock circuit, developed for quartz crystal wristwatches.

Operates from 10-14 Volts D.C. An accessory unit which mounts on the back adapts the unit to 20-28 volts for twin engine aircraft and larger boats using 24 Volts ignition. Know how disgusted you are with the usual car clock? Order this fine unit now for rallying, sports events, navigation, or just to have a fine chronometer that will give you a lifetime of superbly accurate time.

- Quartz Chronometer, Kit Form \$59.50
- Quartz Chronometer, Wired \$99.50
- 24 Volt Adapter \$10.00



DIGITAL CLOCK KIT WITH NIXIE DISPLAY

Because we have made an extremely good purchase of over 20,000 nixies, we can sell a complete digital clock kit for less than the usual cost of the display tubes alone. We provide a complete etched and thru-plated circuit board, all integrated circuits, complete power supply, display tubes, I.C. sockets and a nice front panel with polaroid visor. We have never seen anyone offer this kit for less than \$100.00 before. Includes BCD outputs for use as with timer option. May be wired for 12 or 24 hour display. Indicates hours, minutes and seconds.

- Clock Kit, complete less outside cover . . . \$57.50
- Aluminum blue or black anodized cover . . . \$4.50

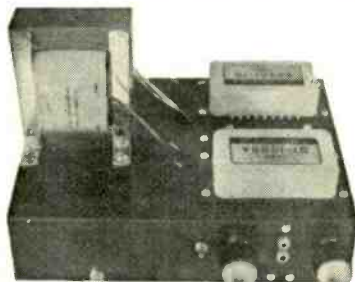

AUDIO AMPLIFIER KIT

This is not our prettiest kit, but it sure does perform. Hybrid Sanken audio modules make wiring easy. Output ratings are maximum continuous at 1000 Hz with a distortion less than 0.5% into a load of 8 ohms. Response is ± 0.5 db 20-20K Hz @ 1 watt. Chassis supplied is heavy gauge anodized aluminum. Capacitors are all computer grade. Level controls on both inputs.

- 100 Watt (RMS) Stereo Kit \$88.00
- 50 Watt (RMS) Stereo Kit \$58.00
- 20 Watt (RMS) Stereo Kit \$30.00



50 MHz DIGITAL COUNTER LABORATORY SPECIFICATIONS AT A BUDGET PRICE!

We feel the most important thing about building a kit is saving money. There are a lot of other advantages of course . . . maintainability, use of standard parts, complete documentation, and the experience and fun of building it, but the overriding consideration is economy. This kit costs less than half that of the lowest priced competitive unit on the market.

The Aries 50 MHz counter is designed for years of maintenance free service. MSI integrated circuitry, cold cathode display tubes and conservatively rated transformers mean low temperature rise. All displays and I.C.'s are in sockets for easy maintainability. The master oscillator is a 1.0 MHz crystal in a custom designed cosmos oscillator circuit, having a stability of ± 3 PPM. Accuracy is 0.005% worst case, 0.0002% or better when adjusted to WWV with a communications receiver. A front panel selects a timing interval of 1.0 seconds, 0.1 seconds or 10 milliseconds. A variable monostable multivibrator holds the count on the front panel for a period of a fraction of a second to infinity. For use in the period mode, the 1.0 MHz oscillator is connected to the main counting chain and gated by the input signal.

Assembly time for the kit is approx. 10 hours. The semiconductor complement is (1) 7400, (1) 7408, (1) 7442, (10) 7490, (2) 74122, (6) 74141, (1) 74193, (1) 74196, (1) 74S11, (1) CD 4007AE, (1) LM309, (6) Diodes, and (1) Transistor. If you always wanted a laboratory quality counter, but could never justify the price, here is your chance.

- 50 MHz Counter Kit, Complete with Crystal Time Base and Case - Postpaid in USA \$125.50



POCKET CALCULATOR

We expected a favorable reaction to our calculator, however, we were overwhelmed when we received orders for hundreds at a time. The reaction of our customers was that they felt this was the most advanced pocket calculator on the market, and priced so low, they could assemble and market it at a profit. The features that make this so exciting are:

- So compact it fits in a shirt pocket (3-13/16 x 4-5/8 x 1-1/4).
- Performs every function you would expect in a desk calculator, and them some, multiplies, divides, adds, subtracts and gives true credit balance. Includes constant and chain operation, full floating decimal, suppressed trailing zeroes, and automatic single entry squaring.
- Powered by self contained AA batteries with up to six hours operation (Nicaid batteries with charger option, up to five hours per charge).
- Calculations performed by a single 40 pin LSI (large scale integration) chip. Displays are 8 digit LED's (light emitting diodes) and overflow and minus signs are also LED's.

As a student, engineer, salesman, accountant or anyone who would like fast accurate answers, this calculator fills the bill, and at a price that unquestionably makes this the lowest price high quality calculator available.

- Pocket Calculator Kit \$75.00
- Pocket Calculator Completed \$99.00
- NiCad Batteries & Charger \$17.50
- Batteries & Charger Completed \$25.00



16 DIGIT ELECTRONIC DESK TOP CALCULATOR KIT

Just one evening puts it together. Even if you have never assembled a kit before, our comprehensive step-by-step manual makes it easy. This calculator adds, subtracts, multiplies, divides & divides by a constant. Has full 16 digit capacity with 8 decades of display and zero suppression. Entries and answers with greater than 8 digits can be displayed in their entirety in two alternate sections: the last eight digits and those digits exceeding eight. Negative results are correctly displayed, and an error symbol indicates an overflow beyond the 16 digit capability. Sequential operations can be performed using the answer to the previous operation as one of the entries for the next. The decimal point can be positioned following any of the eight least significant digits and will be carried automatically during subsequent operations. An additional good feature, concerning the beginner, is that all major components are in sockets, making troubleshooting easy. And if all else fails, (an unlikely occurrence) you can send it back to Aries and we will fix it for a maximum of \$10.00, no matter what is wrong, barring gross negligence.

- Kit - with Power Supply & Case \$99.00

Dear Customers:

Due to the tremendous demand for B & F Electronic kits a new company, ARIES/BF, has been formed. This move provides a complete, well staffed organization to deal with kits and only kits, thus offering faster delivery, better service, and most important of all, a continuing flow of new kits that will advance the "state of the art" in their fields.

The activities of the entire staff of ARIES/BF will be devoted full time to satisfying your needs and providing you with a large selection of interesting and up-to-the-minute kit devices for the home, the car, and the electronic shop.

Although ARIES is still at the mercy of vendors for their delivery in some cases, every effort is being made to develop sufficient inventory to be able to assure off-the-shelf delivery of all our kits.

Sincerely,

Arthur Pennell

Arthur Pennell
President, ARIES/BF

ARIES INC.
119 Foster Street, Peabody, Mass. 01960
(617) 532-0450

Please send:

Qty.	Description	Amount

Name _____

Address _____

City/State _____ Zip _____

Check Enclosed Master Charge BankAmericard

M.C. No. _____

B.A. No. _____

Expiration Date _____ Bank No. _____

Please call factory for quantity prices

Circle 92 on reader service card

EDI

THOUSANDS OF BARGAINS—TOP VALUES IN Electronic Parts

Transistors, Modules, Speakers, Stereo, Hi-Fi, Photo Cells and thousands of other Electronic Parts. Send for **FREE** Catalog





ELECTRONIC DISTRIBUTORS INC.
Dept. TA-2, 4900 Elston
Chicago, Ill. 60630

RUSH CATALOG

Name _____
Address _____
City _____ State _____ Zip Code _____

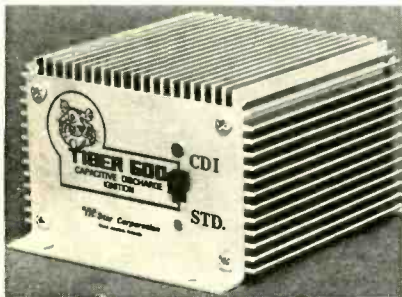
Circle 95 on reader service card



12 REASONS YOUR CAR NEEDS A TIGER 500

Instant starting in any weather - Eliminates tune-ups - Increases gas mileage - Increases horsepower 15% - Improves acceleration & performance - Spark plugs and points last up to 70,000 miles - Reduces engine maintenance expense - Amplifies spark plug voltage to 45,000 volts - Maintains spark plug voltage to 10,000 RPM - Reduces exhaust emissions - Dual Ignition switch - Unconditional guarantee for original owner - Installs in 10 minutes on any car with 12 volt negative ground - No rewiring - Most powerful, efficient and reliable Solid State Ignition made.

SATISFACTION GUARANTEED
or money back.

Assembled \$49.95
Post Paid in U.S.A.

Send check or money order with order to:

Tri-Star Corporation

Dept. R, P. O. Box 1946
Grand Junction, Colorado 81501
DEALER INQUIRIES INVITED

Circle 94 on reader service card

EQUIPMENT REPORT

(continued from page 54)

dition of each battery can be read by turning the meter selector switch to BATT TEST. To save battery power, the on-off switch is a spring-return type. Power is drawn only when readings are actually being taken.

For receiver alignment, a double PIN-diode attenuator is used. This provides accurate control of the rf output over the entire range from 25 to 1000 MHz. This is a special voltage-controlled device. The control voltage applied can be monitored by placing the selector switch in the A position.

Receiver i.f. stages can be accurately aligned by installing the proper crystals. Any frequency between 5 and 20 MHz can be generated on fundamentals, and up to 40 MHz using harmonics. A lot of dual-conversion receivers use a 5.0 MHz "High i.f.," so this one could be very useful.

Internal construction of the instrument is rugged. A heavy PC board holds two IC's, used in the counter circuits, 5 transistors, plus the other parts. The whole thing is housed in a rugged steel case, with storage space in the lid for calibration charts, cables, the pickup antenna, earphones, etc.

For the operating tests, we took it out to the local airport. We checked several of our friend's aircraft (and some found wanting!) and tuned up. Even in the crowded quarters of the "offices" of some of these Bamboo Bombers, we had no trouble using this convenient little instrument. All in all, a very compact, accurate and useful instrument, and one that will make some difficult jobs a lot easier. **R-E**

advertising contributed for the public good

FOR PEOPLE WHO NEED PEOPLE.

The American Red Cross.

PAIA HAS THE MOST UNUSUAL KITS AVAILABLE



Wind Chimes
The original background music system. Centuries old idea reproduced electronically. Trimmer adjustments select the ring of brass chimes or the percussive resonance of bamboo rods. Use with any amplifier.

No. 3721 \$16.95

Other Kits: SURF SYNTHESIZER NO. 3711 \$11.95
SOLID STATE BIRO NO. 1710 \$ 6.95

Plus electronic music accessories and many more.
Please add 50¢ postage & handling to orders.

Write for FREE Catalog
PAIA Electronics, Inc.
Box R14359, Oklahoma City, Oklahoma 73114

the EL SOCKET

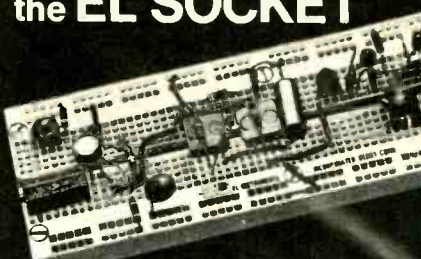

**Test new circuit ideas...
I.C. circuits...
discreet components...
at no risk!
Money back guarantee!**

\$17²⁵

All you need are #4 mounting screws . . . just plug-in components . . . like 1/4 watt resistors, ceramic capacitors, diodes, I.C.s, transistors and more . . . and your circuit's built! No special patch cords needed! Components interconnected with any solid No. 22-26 gauge wire. And you can try it with absolutely no risk for 5 days. If not satisfied, just return your EL Socket and receive a full refund. Trying is believing. How can you go wrong? Order your EL Socket now!

- Nickel/silver plated terminals — very low contact resistance
- Low insertion force
- Mounts with #4 screws
- Initial contact characteristics beyond 10,000 insertions
- Vertical, horizontal interconnecting matrices
- Accommodates wide range of wire and component leads from .015"-.032"

Send check or M.O. today!

- Add 50¢ for postage and handling
- 25% deposit on C.O.D.s

EL INSTRUMENTS, INC.
61 First St., Derby, Conn. 06418
Telephone: 203/735-8774

EL Instruments, Inc.
61 First St., Derby, CT. 06418

Please rush _____ EL SOCKET(S) @ \$17.25 each, for which I enclose _____ plus 50¢ for postage and handling. I understand that I may try it FREE for 5 days and if not satisfied I may return it for a full refund.

NAME _____
STREET _____
CITY _____
STATE _____ ZIP _____

Circle 93 on reader service card

market center

BUSINESS OPPORTUNITIES

START SMALL HIGHLY PROFITABLE ELECTRONIC PRODUCTION AT HOME. INVESTMENT, KNOWLEDGE UNNECESSARY. Postcard brings facts. **BARTA-RAH**, Box 248, Walnut Creek, CA 94597

EMPLOYMENT Information—Electronic Technicians—How to earn 15,000-20,000 yearly. Not field service. Not over seas. Work in U.S.A. Details 3:00. **W.L.D. CONTRACT ENGINEERING**, 8450 Anthony Wayne Ave., Cincinnati, OH 45216

PLANS AND KITS

ANTIGRAVITY DEVICE. Brochure rushed free. **AGD**, Box 3062, Bartlesville, OK 74003

ELECTRONIC ORGAN KITS, KEYBOARDS for music synthesizers and organs. Every component for organ circuitry. 25¢ for catalog. **DEVTRONIX ORGAN PRODUCTS**, Dept. B, 5872 Amapola Drive, San Jose, CA 95129

CONSTRUCT Quality but very inexpensive inverter transformer for CD ignition or other uses. Dollar brings instructions. **HOFFMAN** Box 838, Enterprise, AL 36330

PROFITABLE ELECTRONICS DEVICES. Plans, instructions, sources and **COMPLETE BUSINESS SETUP. LET YOUR SKILL PAY!** Free literature. **BARTA-REH**, Walnut Creek, CA 94597

CONVERT any television to sensitive big-screen oscilloscope. Only minor changes required. No electronic experience necessary. Illustrated plans \$2.00. **RELCO**—A25, Box 10563, Houston, TX

BUILD your own **TELEPHONE ANSWERING SERVICE.** Put your **TAPE RECORDER** to work. Detailed plans \$3.90. **TONASCOPE-E**, 400 Third Ave., Satellite Beach, FL 32937

INVENTIONS & PATENTS

INVENTIONS Wanted Patented; Unpatented. **GLOBAL MARKETING**, 2420-AE 77th Ave., Oakland, CA 94605

EVERYTHING IN SEMICONDUCTORS
YOUR CHOICE FROM OVER 300 POPULAR DEVICES. IF YOU DON'T SEE IT HERE, ASK FOR IT.

PART #	MOTOROLA PART REFL	DESCRIPTION	CASE STYLE	PRICE P-99
D8	103	Zener Diode 6.2V 1W 5%	DO-7	\$.70
D4	104	Zener Diode 9.1V 1W 5%	DO-7	.70
D5	105	Zener Diode 12V 1W 5%	DO-7	.70
D8	135	GE Diode 1N40 Subal.	DO-7	.16
D8	165	Sei Dual Diode Com. Cathode	DO-8	.33
R2	153	Si Pwr Rect 200V 15A	DO-4	1.32
R7	159	Si Rect Ax lead 800V 2.5A	DO-41	.40
R9	161	Si Rect Ax lead 50V 3A	20	.66
R11	170	Si Rect Ax lead 1000V 2.5A	DO-15	.55
R47	100	B- Boost Rectifier 800V	—	.60
R49	—	6500 volt Focus Rectifier	30	1.20
GT3	3	GE RF Tr PNP 250 MHZ	TO-18	1.77
GT6	231	GE Pwr Tr PNP 15A	TO-36	1.36
GT7	232	GE Pwr Tr PNP 7A	TO-3	1.65
GT8	233	GE Pwr Tr PNP 15A	TO-36	2.97
GT29	632	GE Audio Ampl. PNP	TO-5	1.10
GT36	639	GE Drift-Field PNP	TO-18	.99
GT38	841	GE RF Ampl. PNP	TO-5	.88
GT40	643	GE Audio Pwr Ampl. PNP	TO-66	1.15
ST2	51	Si RF Tr PNP 30 MHZ	TO-3	1.77
ST5	54	Si RF Tr NPN 30 MHZ	TO-5	.66
ST6	55	Si RF Tr NPN 200 MHZ	TO-92	.70
ST7	56	Si VHF Osc. NPN 750 MHZ	TO-92	.88
ST11	240	Si Pwr Tr NPN 300V 10W	TO-66	1.20
ST14	243	Si Med Pwr Tr NPN 60V 3A	TO-5	1.10
ST17	246	Si Med Pwr Tr PNP 60V 3A	TO-22	1.32
ST18	247	Si Pwr Tr NPN 70V 10A	TO-46	.99
ST20	310	Si Unijunction Tr 300mW	TO-92	.99
ST25	703	Si Audio Pwr Ampl. NPN	TO-66	1.76
ST26	704	Si Audio Pwr Ampl NPN	TO-3	1.43
ST42	721	Si Audio Ampl. NPN 260 MHZ	TO-92	1.50
ST69	3001	Si RF Pwr Tr NPN 65V 5W	TO-5	2.30
FET1	801	Fet Audio N Channel	TO-46	.99
FET2	802	Fet RF N Channel	TO-46	.99
FET3	803	Fet Audio RP P Channel	TO-46	2.10
TH5	320	Thyristor (SCR) 30V 800ma	TO-18	.60
HRI	175	Pull Wave Bridge 50V 3A .750/.800Rd	—	.60

Terms: Add 25¢ for postage
Minimum Order 2 Dollars.
Send 10¢ for Complete catalog.

GF Electronics
P.O. Box 14
Greenwood, Mass. 01880

Circle 101 on reader service card

CLASSIFIED COMMERCIAL RATE (for firms or individuals offering commercial products or services). 90¢ per word . . . minimum 10 words.
NONCOMMERCIAL RATE (for individuals who want to buy or sell personal items) 60¢ per word . . . no minimum.
FIRST WORD and NAME set in bold caps at no extra charge. Additional bold face at 10¢ per word. Payment must accompany all ads except those placed by accredited advertising agencies. 10% discount on 12 consecutive insertions, if paid in advance. Misleading or objectionable ads not accepted. Copy for January issue must reach us before Nov. 1.

CLASSIFIED ADVERTISING ORDER FORM

1	2	3	4	5
6	7	8	9	10
11	12	13	14	15
16	17	18	19	20
21	22	23	24	25
26	27	28	29	30
31	32	33	34	35

No. of Words { @ .60 Non-Commercial Rates } = \$ _____
 { @ .90 Commercial Rate } = \$ _____
 No. of Words in bold caps @ .10 = \$ _____

Total Enclosed \$ \$ _____

Insert _____ time(s)

Starting with _____ issue

NAME _____

ADDRESS _____

CITY _____ STATE _____ ZIP _____

SIGNATURE _____

MAIL TO: RADIO-ELECTRONICS, CLASSIFIED AD DEPT., 200 PARK AVE. SOUTH, NEW YORK, N.Y. 10003

Payment must accompany order unless placed through accredited advertising agency 28

"WINTER SALE" NEW GUARANTEED DIP IC'S

7400	7401	7402	7403	7404
7405	7410	7420	7430	7408
7440	7450	7453	7454	7460

EACH \$2.3

LOW POWER UNITS—WHY USE BIG EXPENSIVE POWER SUPPLIES? THESE IC'S USE ONLY ONE TENTH THE CURRENT

74L00	74L04	74L08
74L10	74L20	74L30
74L51	EACH \$4.0	

74L73	74L74	EACH \$9.0
-------	-------	------------

HOT PRICES!!

7441	7442	EA. \$1.10	7475	EA. \$.75	
7446	7447	EA. 1.10	7486	EA. .55	
7448	7483	EA. 1.40	7490	7493	EA. .75
7472	7474	EA. .45	7495	7496	EA. 1.00
7473	7476	EA. .50	74192	74193	EA. 1.80

SOPHISTICATED IC'S

DM 8200	4 Bit Magnitude Comparator	\$1.90
(Indicates Less-Than, More-Than, or Equal)		
DM 8281	Presetable 4 Bit Counter	1.30
DM 8520	Modulo N Divider-25 MC	1.90
DM 8570	8 Bit Serial-To-Par. Shift Reg.	1.90
DM 8590	8 Bit Par-To-Serial Shift Reg.	1.90
DM 86L70	Lo-Power Version of DM 8570	2.50
DM 8601	Retrig. Mono. Multivibrator	1.20
DM 8880	7 Segment Neon Decoder-Driver	2.50
SE 566	Function Generator—TO-5 Or Dip	3.25
SE 567	Tone Decoder—TO-5	3.25
SE 565	Phase Locked Loop	3.25

THE MONSANTO MAN-1 DISPLAY \$4.00
L.E.D.—7-SEGMENT—D.I.P.
NOT SOME "SIMILAR TO" OR "LIKE" COPY

LM-309K	5 Volt-1 amp Regulator—To-3 Package—Short-Circuit Protected	\$2.25
	Visible Light Emitting Diode	.60
LM 351	Dual Driver—Each Driver Has TTL 2-Input Nand Gate Control Of Output Transistor Rated Up To 30V. 3A	1.90
LM 380	2 Watt Audio Amplifier	2.25

8223 FIELD PROGRAMABLE ROM
256 BIT WITH 32 8-BIT WORDS
ONLY \$8.00 ALSO—WE WILL PROGRAM FOR \$5.00 MORE—IF WANTED
All Shipments First Class Mail—Free To You
Missourians—Add 4% Sales Tax

JTM ASSOCIATES
P.O. Box 843 Manchester, Mo. 63011

Circle 102 on reader service card

WORLD FAMOUS SEMI-KON Dollar Stretchers

- 1-2N3055 npn, 100w 15A, TO-3, transistor \$1.1
- 2-2N3572 UHF, 1000mc, npn, TO-92, plastic transistor \$1.1
- 3-ER900 TRIGGER DIODES for SCRS \$1.1
- 4-2.5 AMP 25V PIV, silicon epoxy rectifiers \$1.1
- 5-VARACTOR DIODES, 100p, 20p, 30p, 40p, 50p \$1.1
- 2-FET'S 2N5457 N channel 6000 umhos, TO-92 plastic \$1.1
- 1-90 WATT PNP, 15A, 2N2612, TO-3, silicon \$1.1
- 2-2N389 npn, silicon, 85 watts, Vce 80, square case \$1.1
- 3-2N122 npn, silicon, 85 watts, Vce 60, stud case \$1.1
- 10-1N914 fast switch diodes, silicon 4 nanoseconds \$1.1
- 10-2N404 germanium npn, TO-6 chrome case \$1.1
- 2-6 AMP TRIAC 200 PRV, TO-5 \$1.1
- 40-G-E MICRO MINI RECTIFIERS, silicon, porcelain to 1KV \$1.1
- 40-RECTIFIERS & ZENERS, 1W & 1A, bullets, assorted volts \$1.1
- 30-WORLD'S SMALLEST RECT. & zeners, 1W, assorted volts \$1.1
- 1-FAIRCHILD 2N3919 80mc, 15w, npn, 10A, TO-66 \$1.1
- 5-2N3638 PNP, silicon, TO-6 plastic transistors \$1.1
- 5-2N3641 NPN, silicon, TO-6 plastic transistors \$1.1
- 4-2N4269 Nixie tube driver transistors 100V, npn \$1.1
- 2-FET'S 2N3085 N channel, 10,000 umho TO-18 transistors \$1.1
- 2-PUTS, pnp, uni-transistors, similar to GE-D13T \$1.1
- 2-2N2608 P channel, 2500 umho, TO-18 \$1.1
- 2-2N3819, Texas, N channel, 6500 umho, TO-18 \$1.1
- 6-TRIGGER DIODES, for SCRS only, axial leads \$1.1

ALPHA-NUMERIC 7-SEG. READOUTS

2.50 3 for \$6.

- MINI-7 1.75 x 1.7" .360 x .570" 1.5V AC/DC 42 mls
- SLIM-7 1.6 x 0.375" .40 x .20" 1.5V AC/DC 42 mls

*Compatible with segment decoder IC's.

All 3 have O-97 numerals, decimals and letters. SLIM-7

MINI-7

- Flourescent Blue-Green Socket - 20c
- SLIM-7 Socket - 50c
- Flourescent Blue-Green Socket - 50c

- 3-2N2646 UNIUNCTIONS, plastic transistors, Texas \$1.1
- 5-2N107, most commonly used, germanium \$1.1
- 3-3-AMP 1000V epoxy bullet, silicon rectifiers \$1.1
- 50-SILICON, glass rectifiers, computer, axial leads \$1.1
- 50-GERMANIUM, glass rectifiers, signal, axial leads \$1.1
- 5-2N170, GE, RF, germanium, npn, transistors, TO-22 \$1.1
- 10-1-AMP 1000V, epoxy, submini, silicon rectifiers \$1.1
- 3-500 MW ZENERS, axial, 5, 3, 0, 12V rectifiers \$1.1
- 2-2N3055, HOBBY, 40W npn silicon transistors, TO-3 \$1.1
- 5-2N155, HOBBY, 10W pnp germanium transistors, TO-3 \$1.1
- 3-50 AMP SILICON RECTIFIERS, silicon, 6, 12, 24 volts \$1.1
- 5-2N1038, TEXAS, germanium npn, 20 watts, TO-5 w/sink \$1.1
- 10-2N3054 hobby, npn, TO, silicon, 30W, 30mc \$1.1
- 10-SCRS, assorted, TO-5, TO-18, TO-46 \$1.1
- 3-3-AMP RECTIFIERS, silicon, epoxy, assorted V, axial \$1.1
- 1-SN7441N, hobby, BCD-to-Nixie driver IC, DIP \$1.1
- 10-LINEAR AMPS, 709, 710, 711, 741, TO-5 \$1.1
- 10-709 LINEAR AMPS, 741's top, DIP \$1.1
- 5-HOBBY MEMORY CELLS, SN7481, up to 16-cell, DIP \$1.1
- 10-709, 710, 711 LINEAR AMPS, brand new, flat pak \$1.1
- 2-2N5296 35-WATT NPN PLASTIC TRANSISTORS for any 540 \$1.1
- 2-2N6109 40-WATT PNP PLASTIC TRANSISTORS for any 540 \$1.1
- 10-RCA CA-3000 OP AMPS, TO-5 case \$1.1
- 3-723 VOLTAGE REGULATORS, TO-5, 100, 500, 1000 \$1.1
- 4-1000V DARLINGTON transistors, TO-18 case \$1.1
- 1-2N5036 HI PWR plastic trans 100 vceo, 7 amp 85 watts \$1.1
- 2-2N5296 HOBBY 35 watts, plastic powers NPN \$1.1
- 2-2N6109 HOBBY 40 watts, plastic powers PNP \$1.1

LED-PHOTO-SOLAR DOLLAR STRETCHERS

- 3-"LEDS", visible, micro-miniature, axial leads \$1.1
- 2-"LEDS", infrared, jumbo, TO-18 \$1.1
- 2-"LEDS", visible, jumbo, TO-18 \$1.1
- 1-"LED", invisible, parabolic reflector, RCA \$1.1
- 1-PHOTO TRANSISTOR, with darlington amp filter, lens \$1.1
- 2-PHOTO TRANSISTORS, with darlington amp, SN777, GE \$1.1
- 2-PHOTO CELLS, Cuires, axial, 7.0 ohms \$1.1
- 2-SOLAR CELLS, round, sq. rect., on power circuits \$1.1
- 2-SILICON SENSORS, TEXAS, H-38 Matchstick, visible \$1.1

SUPER ECONOMY \$1 PARTS "DOLLAR STRETCHERS"

- 30-POWER RESISTORS, 3-to-25w, square, vitreous, asst vals \$1.1
- 6-REED SWITCHES, 2" long, fastest mech. switch \$1.1
- 10-MICRO REED SWITCHES, 1" long, transistor work \$1.1
- 10-TRANSISTOR SOCKETS, for pnp-npn trans. powers too \$1.1
- 1-\$25 SURPRISE PAK, resistors, caps, transistors, etc. \$1.1
- 80-TERMINAL STRIPS, 1-to-8, axial, 10 & 16 lugs \$1.1
- 40-RADIO VAC KNOBS, ass't shapes, colors, styles \$1.1
- 30-SQUARE DISCS, 85mm to .01mf, space-savers \$1.1
- 75-PRE-FORMED DISCS, condensers, printed circuit \$1.1
- 10-PHONO PLUG-AND-JACK SETS, tuners, amps, doubles too \$1.1
- 10-KODAK LENSES, piano convex, silicone, mirror \$1.1
- 50-TUBULAR COND'S, finest caps made, asst. values \$1.1
- 100-PRE-FORMED RESISTORS, 1/2 watt, printed ckt \$1.1
- 30-DIPPED SILVER MICAS, pop values, silvers, too \$1.1
- 50-COILS & CHOKES, if, rf, ant, peaks, osc, parasitic \$1.1
- 10-IC SOCKET-ADAPTERS, TO-5, 1.0 & 2.0, handy \$1.1
- 60-PRE-FORMED RESISTORS, 1/2, 1 & 2W, 1% asst vals \$1.1
- 10-TUBULAR CONDENSERS, to .5mf, to 1kv, molded too \$1.1
- 10-SUBMINIATURE IFS, 455 kcs, 3/4" square, transistor \$1.1
- 10-TUBULAR ELECTROLYTICS, to 100mf, for ac/dc sets, etc. \$1.1
- 18-NE-2 NEON BULBS, for 110vac, 1.0 & 2.0 ft projects \$1.1
- 30-POLYSTYRENE COND'S, finest caps made, asst. values \$1.1
- 30-PANEL SWITCHES, 110vac, micro, rotary, thermal, slide, \$1.1
- 10-VOLUME CONTROLS, to 1meg, duals, too, some w/switch \$1.1
- 40-MICRO MINI RESISTORS, 1/4w, 100 ohm to 1meg, 5% \$1.1
- 30-MOLDED CONDENSERS, upright, axial, to 1mf to 1KV \$1.1
- 50-ONE WATT RESISTORS, 1% & 5%, AB's too, 100 to 1 meg \$1.1
- 10-TRANSISTOR ELECTRO'S, 5mf to 300mf, upright too \$1.1
- 10-UPRIGHT TRANSISTOR ELECTRO'S 5mf to 300mf \$1.1
- 60-CERAMIC CONDENSERS, 10mf to .04, npo's, discs \$1.1
- 40-MICRO-MINI-MINI CONDENSERS, to .05mf, ceram \$1.1
- 5-IBM COMPUTER BOARDS, trans, caps, res, coils, etc. \$1.1
- 10-ELECTROLYTIC COND'S, 2F's, & tubular, 2 & 3 sect. too \$1.1
- 6-TRIMMER POTS, 100, 500, 2K, 5K, 10K, 25K, 1/4w, snap-in \$1.1
- 60-HI-Q RESISTORS, carbon, 1/4, 1/2, 1, 2W 5% \$1.1
- 50-DISC CAPACITORS, to .01, to 1KV, silvers too, asst \$1.1
- 30-MICA CAPACITORS, to .01, to 1KV, silvers too, asst \$1.1
- 35-TWO WATTERS, resistors, carbon, metal-film, 5% asst \$1.1
- 4-MICRO POTS w/knob, snap-in, 1/6W, 25k, 50k 100k, 1meg \$1.1
- 400-PRINTED CIRCUIT PARTS, electro's, trans, etc. \$1.1
- 30-YELLOW PACKET MYLARS, assorted values & sizes \$1.1
- 10-POWER TRANSISTOR SOCKETS, for TO-3, asst types \$1.1
- 3-"MINIATURE" MOTORS, shaft, 3-12vdc, high speed \$1.1
- 64-PLASTIC TRANSISTORS, TO-18, printed circuit \$1.1

- SN74500 Quad 2-input NAND gate \$.99
- SN74501 SN74500 w/open collector \$.99
- SN74503 SN74500 w/open collector \$.99
- SN74504 Hex inverter \$.99
- SN74505 Hex inverter (open coil) \$.99
- SN74508 Dual 2 input NAND gate \$.99
- SN74509 SN74508 w/open collector \$.99
- SN74510 Triple 3 input NAND gate \$.99
- SN74511 Triple 3 input AND gate \$.99
- SN74515, SN74511 w/open collector \$.99
- SN74520 Dual 4 input NAND gate \$.99
- SN74521 Dual 4 input AND gate \$.99
- SN74522 SN74521 w/open collector \$.99
- SN74540 Dual 4 input buffer \$.99
- SN74564 4 wide, 4-2-3-2 in AND-OR inv. \$.99
- SN74573 Dual J-K master slave flip flop \$ 1.98
- SN74574 Dual D edge trig. flip flop \$ 1.98
- SN745113, SN74574 with preset \$ 1.98

First Time Ever Offered At These Prices!

SCHOTTKY TTL IC'S

- Flip flop toggle freq 75mhz to 125mhz
- Switches 4 times faster than standard TTL's

Lowest Prices Largest Selection TTL IC'S

"DIP" Packages Order by type number! Spec sheets on request "ONLY"

Type	Sale	SN7430	.21	SN7474	.39	SN74141	1.45
SN7400	\$.21	SN7437	.50	SN7475	.71	SN74142	1.45
SN7401	\$.21	SN7438	.51	SN7476	.44	SN74150	1.25
SN7402	\$.21	SN7441	1.00	SN7477	.65	SN74151	1.13
SN7403	\$.21	SN7442	1.12	SN7481	1.10	SN74153	1.25
SN7404	\$.27	SN7443	1.21	SN7482	.88	SN74154	1.95
SN7405	\$.27	SN7444	1.21	SN7483	1.25	SN74155	1.39
SN7406	\$.45	SN7445	1.50	SN7486	3.50	SN74156	.99
SN7407	\$.45	SN7446	1.40	SN7489	3.49	SN74157	1.25
SN7408	\$.29	SN7447	1.10	SN7490	6.10	SN74158	1.48
SN7409	\$.29	SN7448	1.25	SN7491	.69	SN74160	1.79
SN7410	\$.21	SN7450	.21	SN7492	.71	SN74161	1.79
SN7411	\$.25	SN7451	.21	SN7493	.71	SN74162	1.79
SN7413	\$.50	SN7452	.21	SN7494	1.10	SN74163	1.79
SN7416	\$.48	SN7454	.21	SN7495	.95	SN74180	1.10
SN7417	\$.48	SN7460	.21	SN7496	1.10	SN74181	4.50
SN7420	.21	SN7470	.39	SN7497	.49	SN74182	1.10
SN7421	.21	SN7472	.32	SN74121	.49	SN74192	1.75
SN7426	.21	SN7473	.44	SN74122	.67	SN74193	1.75
				SN74123	.99	SN74195	1.19

The lowest price digital clock kit (with cabinet) as far as we can see in U.S.A. Scientific Devices' engineering dept. took extra patience in designing to give you the finest digital clock kit using the latest techniques in an easy-to-understand booklet. The cabinet-making section gives it the "interior decorating touch" so that it may fit into any room at home or shop or office. Walnut laminated tapered front cabinet, with gold-line front. Tapered legs for easy viewing. Large G.E. 7-segment fluorescent "blue-green" polaroid glow for the latest easy-viewing. FEATURES: 6 display tubes, completely etched and thru plated circuit board, all IC's. Includes BCD outputs for use with timer, options, may be wired for 12 or 24 hour display. Indicates HOURS, MINUTES, SECONDS. 115 VAC 60 cy. Gift packed. Wt. 3 lbs. Buy 3 - Take 10% off

DIGITAL CLOCK KIT

By Scientific Devices

\$57.

WITH CASE

* Smaller & more compact
* 8" x 5 1/2" x 3" case

Completely wired, ready to use! Not a kit - many kit hours saved!

Most economical and advanced battery operated pocket calculator under \$100. Makes use of the smallest single chip LSI (Large Scale Integration), LED display technology and a unique snap-action keyboard. The 9V battery can be thrown away after use or recharged with the AC power charger (included). Performs Addition, Subtraction, Multiplication, Division functions, including Chain or Mixed Multiplication and Division, as well as true "credit" balance up to 10 digits. For added convenience and simplicity the decimal point is fixed to two places in the eight digit display. Additional display indicators denote overflow beyond the eight digits and negative result (minus sign). Includes simplified instruction booklet. Factory guarantee. Gift packed. Size: 3 1/2" x 5 1/2"

8-DIGIT ELECTRONIC POCKET CALCULATOR

Battery and Electric Includes Battery Charger

\$99.95

Uses LSI Chip & LED Display

NEW FOR 1973!

Never before offered at this price! You've seen them at \$175, \$149 - but now at a price calculator users can afford. EIGHT-DIGIT fluorescent display has 16-digit capacity. Adds Subtraction Multiplies and Divides in chain or mixed calculations. Includes MINUS sign showing negative credit balance, OVERFLOW INDICATOR to the eight power, CONSTANT (K) MEMORY switch. Floating decimal or 2, 3, 4, 5 decimal points as required. (CE) key clears calculator of last entry error. Automatic loading and trailing zero suppression. LSI (Large Scale Integration) equivalent to more than 8,000 transistors. Calculation speed adds and subtracts 10,000th of a second. Keyboard is REED SWITCH assembly for extensive trouble-free operation. Separate power switch. Removable 115 operation. Power 110-120 VAC 60 cycles. Wet VAC line cord. Power black molded cabinet with silver trim, size: 9 1/2" x 5 1/2" x 3 1/4". Complete with easy-to-understand booklet. THE ONLY FACTORY GUARANTEED CALCULATOR BY A MAIL ORDER ADVERTISER. Gift Packed!

ELECTRONIC CALCULATOR

COMPLETELY WIRED

Only **\$99.95**

NOT A KIT

Buy 3 - Take 10% Discount

Uses single Texas Instrument "Chip" Features found in more expensive units

Unique Scientific Device, "hand claps", sensitizes crystal mike amplifier, triggers SCR. Needs only 3 to 6V. Use as burglar alarm intruder detector. Use with photo cell, trigger SCRS, relays, LED's. Even fiber optic light pipe may be used. With hand booklet.

MAGIC "SOUND TRIGGER"

\$1.98

NIXIE TUBE SALE \$2.50

Burroughs B79/1, 0-10-9, A-10-2, 2 1/2" high characters, 170V.

EPOXY FULL WAVE SILICON BRIDGE RECTIFIERS

50 2 Amp 6 Amp \$1.22 \$1.69 \$1.88
100 200 95 1.25 1.50
400 1.19 1.50
600 1.35 1.75
800 1.59 1.95
1000 1.79 2.25

Code: 2 amp TO-5 case
6 Amp 1/2 x 1/2 x 3/16 sq

LINEAR Op Amps

Type	Description	Sale
531	Hi slew rate op-amp	\$2.50
532	Micro power 741 TO-5	2.50
533	Micro power 709	2.50
536	FET input op amp	2.50
537	Precision 741 TO-5	2.50
540	70W pwr driver amp	2.04
550	Precision 723 voltage reg.	1.19
555	Timer 2 uSeconds to 1-hour	1.17
558	Dual 741 (mini DIP)	.88
565	Phase lock loops (A)	3.25
566	Function generator (Mini DIP)	3.25
567	Tone decoder (Mini DIP)	3.10
595	Four quadrant multiplier	1.00
702C	Hi-gain, DC amp, TO-5	2 for 1.00
703C	RFIF, amp, 14 ckts, TO-5	1.00
709C	Operational amp (A)	.39
710C	Differential amp (A)	.39
711C	Dual diff. comp (A)	.39
723C	Voltage regulator (A)	.95
741C	frequency compensator 709(A)	.41
747C	Dual 741C, (A)	1.25
748C	Freq. adj. 741C (A)	.44
709-709	Dual 709C (DIP)	1.00
739-739	Dual stereo preamp	1.00
741-741	Dual 741C (A)	1.00
749-749	Dual channel amp	1.98

(A) TO-6 or DIP dual in line pak

LOW PRICES ON 'TRIACS'

* Two SCRs in one case! * Most complete listing!

50	3 amp	8 amp	10 amp	15 amp	25 amp
100	.35	.52	.64	.85	1.05
200	.65	.72	.88	1.25	1.45
300	.79	.89	1.10	1.45	1.68
400	.92	1.19	1.35	1.85	1.95
600	1.50	1.69		2.55	2.25

3 & 6 amp TO-5, 10 amp TO 66, 15 & 25 amp stud.

STEREO PREAMP IC

Dual 739-739 8-transistors per channel. 50K in. imp.; for phono-tape 20-20,000 mc. DIP. Fairchild.

Choose Any **1.95**

1-WATT AUDIO AMP

8-transistors in TO-5 case. 400K in. imp. Westinghouse WC334. TO-5.

INTEGRATED CIRCUIT SOCKETS

Buy Any 3 - Take 10% Discount!

- 14-Pin, dual in line \$.45
- 16-Pin, dual in line \$.50
- TO-5, 8 or 10 pins \$.29

Terms: add postage, cod's 25%. Rated: net 80
Phone Orders: Wakefield, Mass. (617) 245-3829
Retail: 211 Albion St., Wakefield, Mass.
C.O.D.'S MAY BE PHONED IN

15¢ CATALOG on Fiber Optics, 'IC's, Semi's, Parts

POLY PAKS

P.O. BOX 942R, LYNNFIELD, MASS. 01940

EXCLUSIVE ECONOMY-PACKED DOUBLE BONUS Sale

BONUS #1
Free \$25
Add 25¢ for handling
NORTH
SOUTH
EAST
WEST
ICs, DIODES
TRANSISTORS
RECTIFIERS
ZENERS
CONDENSERS
INDUCTORS, ETC.
PLUS CHOOSE
ANY ITEM
\$1 OR LESS
FREE

BOTH FREE WITH ANY \$10. ORDER

BRAND NEW LOWEST PRICES
GENERAL ELECTRIC \$2.95
3 FOR \$6.00
PA-263

3-WATT AUDIO AMP
Delivers 3.5 watts continuous, 10 watts peak. With heat sinks: micro-mini size: 3/4" x 2 1/2". 9 to 30V supply. High sensitivity, 8 to 16 ohms. For mono and stereo phonos, tape, FM, AM, TV, servo.

PHILCO 11 TRANSISTOR AM RADIO CHASSIS

Use as:
● Mike amplifier
● Phono amplifier
● Tape amplifier
● Covers 555 Kcs to 1500 Kcs Broadcast band
● AC or DC
Only \$5.95

One of the most versatile AM Radio and multi-purpose amplifiers we have seen at Poly Paks famous "Economy" price. Measures only 4 1/2" x 3" x 2" high. With tuning capacitor, IF circuitry, loopstick, ant. volume control with switch, AC and phono-mike jacks. Separate switch for changing from AM radio to amplifier. Uses either 110V plug-in adapter (not with unit) and a 9-volt battery power. Exceptional sensitivity and power. Feeds into 16 ohm speaker. Complete with spec sheets, diagrams, and hookup ideas.

8 TRANSISTOR AMPLIFIER CHASSIS
Only **\$3.95**

Same section of the chassis. 4 1/2" x 4" x 2" high.

IT'S NEW! 12-DIGIT 3 for \$35
"CALCULATOR ON A CHIP" \$12.95

Sorry, can't name U.S. maker! Type SD5001. Similar to Mostek 5012. Outperforms Texas 8-digit TMS-1802. Features: 40-pin DIP; not 5, not 3, but only single "calculator chip". 12-digit capacity: adds, subtracts, multiplies, divides, fixed point (0, 2, 3 or 4 decimal places), chain operations, leading zero blanking, 7-segment decoded display output, overflow lockout, and negative sign output. Drives incandescent, fluorescent, Nixies, and LED readouts, complete with instruction booklet.

3.88 SOLID STATE AM-FM TUNER
FM 88-108MHz & AM 550-1600Kcs. Sensitive 2 3/4" x 2 1/4" x 1 1/2" module. Can be used with 10.7mc & 455Kcs IF strips & any hi-fi amp. P.C. wired. 4-gang, variable supply voltage 9V 6 mils. Varactor diode for AFC. Schematics.
WESTINGHOUSE 3 for \$10

0-9 plus letters, for SNT446 or SNT447. Snaps in 14-pin DIP socket. 3/4" x 3/8" x 3/8" characters. 1/4" x 9/16" 5V, 20-mils per seg. characters: 1/4" x 3/16" Famous MAN-1 type.
● Sockets .80 ea.
LED READOUTS \$4.50
3 for \$12.

LED READOUT COUNTING SYSTEM \$8.88
3 for \$24

'PIK-A-PAK' FACTORY IC KITS
● Factory To You! With Diagram!
● No Test!
● 24-709, 710, 711, 723, 741 asst. cases \$2.98
● 24-7400 Series, Dual in line, asst. cases 1.98
● 24-Linear & 7400 Series, asst. cases 1.98
● 10-709, 710, 711, 723, 741, 70-5 1.00

Type G, 1/2" dia. x 1/2" high, Mounts 1/4" hole, with shaft, linear, immersion-proof high freq.
ALLEN BRADLEY 'MICRO-POTS'
● 75 2.0K 7.5K 25.5K 2 for \$1
● 100 2.5K 10.0K 75.5K
● 500 5.0K 20.0K 100.0K 5 Meg
We stock Locknut Bushing & Screwdriver types at same low prices.

Type F, Screwdriver adjust.
ALLEN BRADLEY'S 'TRANSISTOR' POTS
Ohms
● 75 250 1.0K 7.5K 25.5K 250K Any
● 100 50 1.0K 10.0K 75.5K 2 Meg 2 for \$1
● 200 750 5.0K 20.0K 75.5K 5 Meg \$1

Terms: add postage, cust's 25%. Rated: net 30
Phone Orders: Wakefield, Mass. (617) 245-3429
Retail: 211 Albion St., Wakefield, Mass.
C.O.D.'S MAY BE PHONED IN
POLY PAKS P.O. BOX 942R
Lynnfield Mass. 01940

FOR SALE

DIGITAL ELECTRONICS! Complete schematics, parts lists, theories—Discrete Component Digital Clock, \$3.00—Sound Sensitive Switch, \$1.50. Increase technical competence, hobby skills—Complete Course in Digital Electronics is highly effective, \$10.00. Limited—Clock plans INCLUDED with Course! Free literature. **DY-NASIGN**, Box 60R1, Wayland, MA 01778

ELECTRONIC Ignition—Various Types. Information 10¢. **ANDERSON ENGINEERING**, Epsom, NH 03239

MANUALS for Govt. surplus radios, test sets, scopes, teletypes. List 25¢. **BOOKS**, 4905 Roanne Drive, Washington, DC 20021

WRITE for our free 32 page catalog. It lists resistors (14 different types, in kits and singly), 1542 tube types, 3024 different transistor types, many transistor kits, rectifiers in kits and singly, condensers of various types, tools, wire, antennae, phonograph cartridges and needles, speakers, CRT boosters, controls, switches, t.v. tuners, yokes, flybacks, etc. **HYTRON HUDSON**, Dept. RE, 2201 Bergenline Ave., Union City, NJ 07087

CANADIAN Surplus Catalog \$1.00. ETCO ELECTRONICS, 464B McGill, Montreal, Canada

INTERCOM, Bogen SA10-40, 30 Station, Speakers, offers to **KOSMAN** Box 6251, Lincoln, NE 68506

RECORD TELEPHONE CONVERSATIONS PRIVATELY—AUTOMATICALLY. LEAVE RECORDER UNATTENDED. ROBERT'S, BOX 49RE, PARKRIDGE, IL 60068

LOGIC Probe with LED display \$20.00 postpaid U.S. Order from **UTI** POB 252 Waldwick, NJ 07463



COMPUTER KEYBOARD W/ENCODER \$35
Another shipment just received. Alpha-numeric keyboard excellent condition. Once again we expect an early sellout. Price of \$35 includes prepaid shipment in the US and shipment made within 24 hours of receipt of order.

COMPUTER KEYSWITCHES
Another fantastic bargain for the builder. We have brand new bounce-less micro switch keys, spares from the above units, less key-tops. Make up your own keyboards. Made for PC mount. Package of 48 brand new key-switches only \$12.00 postpaid.



TS 323 FREQ. METER
Similar to the familiar BC 221 except this one covers range of 20—450 mc. Accuracy .005% Used, guaranteed OK, less batteries, with schematic. TS-323 ship wgt 35 lbs. \$50.00

Please add postage for above items
Send 25¢ for Surplus Catalog . . .
JOHN MESHNA JR. ELECTRONICS
P.O. Box 62 E. Lynn, Mass. 01904

Circle 104 on reader service card

LM309K—5 volt regulator
This TO-3 device is a complete regulator on a chip. The 309 is virtually blowout proof, it is designed to shut itself off with overload of current drain or over temperature operation.
Input voltage (DC) can range from 10 to 30 volts and the output will be five volts (tolerance is worst case TTL requirement) at current of up to one ampere . . .
Each **\$2.50** FIVE for **\$10.00**

FOLLOWING ITEMS IN LIMITED QUANTITY	DIGITAL SPECIAL	LINEAR SPECIAL
75451 dual peripheral driver 2 pin DIP \$.75	Ten brand new (on carriers) dual-line JK flip-flops—LU321 with data sheet and two pages of application notes describing hookups for—divide by three, through ten, and twelve. Also self correcting ring counter hookups, etc. 10 LU321 W/data \$4.00	Ten (10) Telodyne TO-5 741 operational amplifiers with a two-page sheet of application notes covering the basic circuits using op-amps. \$.65 each Op-amp package 10-741's, data sheet and application notes only \$5.00
NE565 phase lock loop TO-5 3.50		
NE566 function generator 8 pin DIP 3.50		
NE567 tone decoder 8 pin DIP 3.50		

COUNTER IC SPECIAL	LINEAR IC's (dual-in-line)
Fairchild Dual In Line 958 decade counter and Fairchild 960 nixie* driver combination. These are new and fully guaranteed but are not marked. *Trade Mark	709 operational amplifier 40 710 voltage comparator 75 LM309K 5V-1A power supply module 2.50 LM100 positive voltage reg. 80 747 dual 741 op amp DIP 1.10
combination (2 IC's) \$1.75	
ten sets (20 IC's) \$15.00	

LED Red Emitting Lamp	40 PIN DIP Package
7480 gated full adder80	Add, subtract, multiply and divide.
7483 4 bit full adder 1.60	12 digit display and calculate Chain Calculations.
7486 quad exclusive or gate65	True credit balance sign output. Automatic overflow indication. Fixed decimal point at 0, 2, 3, or 4.
7489 64 bit RAM 4.00	Leading zero suppression. Complete data supplied with chip.
7490 decade counter 1.15	Complete only \$12.95. Data only \$1.00 refundable with purchase
7491 8 bit shift register 1.15	
7492 divide by 12 counter 1.15	
7493 4 bit binary counter 1.15	
74154 one of 16 decoder 3.00	
74181 Arithmetic Logic Unit 4.50	
24 pin DIP	
8261 fast carry for above 2.00	
74192 up/down decade counter 2.25	
74193 up/down binary counter 2.00	
74195 univ. 4 bit SR 1.15	
8280 preset decade counter 1.15	
8281 preset binary counter 1.15	
8520 25 MC divide by "N" 2 to 15 2.00	
7495 4 bit SHIFT REGISTER 1.15	
8590 8 bit shift register 2.00	
8270 4 bit shift register 2.00	
8570 8 bit SI, PO, shift register 2.50	

BABYLON ELECTRONICS SEND FOR FREE FLYER
P.O. Box J
CARMICHAEL, CA. 95608
(916) 966-2111

U.S. GOV'T ELECTRONIC SURPLUS

• Nationally Known-World Famous SURPLUS CENTER offers finest, most expensive, Government Surplus electronic units and components at a fraction of their original acquisition cost.

IBM COMPUTER POWER SUPPLY

• (ITEM #22-954) -- Expensive, regulated unit. Fine for college labs, research co's, service shops, etc. Pure IC over a wide range of voltages. DC output voltages 5, 12, 48, etc. Wide range of AC voltages available.

• Finest transformers, filters, transistor load regulation system. Independent of line voltage fluctuations. Contains five separate rectifier systems. Unit is furnished without small "regulating card" which can be easily made or can be by-passed. Data and circuit diagrams furnished. 30" x 12" x 10" (125 lbs.)

Cost Gov't Over \$500.00 **\$24.95**
ONCE-IN-A-LIFETIME SPECIAL



PTD. CCT. RELAY BOARDS

• (ITEM #22-855) -- Four expensive, tested (\$12.95 each) relay board. 800-ohm, 28-Volt. One printed circuit board plus twelve diodes and other components. 3 1/2" x 3 1/2" x 1 1/2" (12 oz.)

Cost Gov't Over \$70.00 **\$1.49**

STANDARD DIAL TELEPHONE

• (ITEM #718) -- Standard, commercial telephone same as used throughout U.S.A. Attractive polished black, like new condition. Use as extension phone to private system or connect several phones together for local intercom system. Full instructions are furnished. Wt. 9 lbs.



Original Cost \$24.50 **\$7.49**

STEP-BY-STEP TELEPHONE SWITCH

• (ITEM #7-908) -- Amazing telephone selector switch. Great experimental item. When used with two-wire telephone dial will select any number from 0 to 100. Make intercom or private system. Use to turn on remote lights, start motors, etc. Complete with contact bank. 13" x 6" x 5" (16 lbs.) Cost Over \$99.00



Cost Over \$99.00 **\$6.29**

• Telephone dial for use with above switch. Order as (Item #700)..... **\$1.97**

MAGNETIC DIGITAL COUNTER (12 to 18-VDC)

• (ITEM #21-889) -- Use to count electrically. Use to count number of times door is opened after business is closed to show changing prices, laboratory uses, etc. Will count 1 for each pulse and will transfer 10th count to next unit. 4 1/2" x 1 1/2" x 1 1/2"

Orig. Cost Over \$18.00 Each **\$1.99** Three For **\$4.99**

200 AMP., 50 VOLT, SILICON DIODE

• (ITEM #22-863) -- A Four Star Plus New, leading make. Heavy duty units excellent for use in 12 or 24-volt fast chargers, high current power supply systems, etc. 2 1/2" x 1 1/2" x 1 1/2", 34"-16 B&E mounting threads. (1 lb.)

List Over \$15.00 **\$4.99**

AC PROGRAM TIMING CLOCK

• (ITEM #158) -- Zenith 115-VAC unit. Use for periodic signaling, work breaks, classes, turn on radio, etc. All clips permit ON-OFF switching any time in 24 hour period. Also has "skip-a-day" feature. Can be multiple programmed. 8 1/2" x 6 1/2" x 4" (8 lbs.)



Cost Gov't Over \$30.00 **\$15.75**

SNAP AROUND VOLT-OHM-AMMETER

• (ITEM #21-848) -- Measures AC current without opening the line. Simply press handle and snap the probe around the conductor. Reads currents from .25 to 125-amps. Reads voltages to 300, reads ohms up to 500. Test motors, appliances, etc. Three current ranges, two voltage ranges. With case, test leads. 7 1/2" x 3" x 1 1/2"

\$36.90 Reg. Price \$39.95 (2 lbs.)

SPECIAL SALE

Correspondence Course In ELECTRICAL ENGINEERING

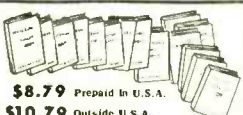

\$8.79 Prepaid in U.S.A.
\$10.79 Outside U.S.A.

• (ITEM #4-180) -- Obtain technical training at low cost! Lincoln Engineering School has suspended its Correspondence Courses because of rising costs. A limited number of Electrical Engineering Courses are available, but without the examination grading service. The course consists of 15 lesson books, each with associated exams and standard answers. Book describing prize winning Home Experimental Laboratory Bench furnished at no extra cost.

RUNNING TIME METER

• (ITEM #2188) -- Record number of operating hours of electric lights and electrical devices such as refrigerators, furnaces, etc. Records total hours, tenths and hundredths up to 9,999.99 hours. For 115-volt, 60-cycles. Size 4 1/2" x 3" x 2 1/2". Shipping weight 2 lbs.



\$4.39 Cost Over \$20.00

COMPUTER TRANSISTORS ON HEAT SINKS

IBM Computer Quality Units

• (#22-928) -- Unit consists of one 150-watt power transistor on heavy ribbed, aluminum heat sink. Many experimental uses. (1 lb.)

Cost Gov't Over \$18.00 **\$1.99**



• (#22-915) -- Unit consists of two 150-watt power transistors, 2 PNP's, several diodes, capacitors, resistors, etc. on heavy, ribbed aluminum heat sink. Ideal for use as motor speed control. (4 lbs.)

Cost Gov't Over \$35.00 **\$4.91**



All items shipped f.o.b. Lincoln, Nebr.
WRITE FOR FREE CATALOGS
Order Direct From Ad. Money Back Guarantee.

SURPLUS CENTER

Dept. RE-112 Lincoln, Nebr. 68501

ADVERTISING INDEX

RADIO-ELECTRONICS does not assume responsibility for any errors which may appear in the Index below.

READER SERVICE CARD NO. PAGE

Amperex.....	2
Artes, Inc.....	101
92 Bell & Howell Schools.....	24-25
88 B.F. Enterprises.....	99
77 B & K, Division of Dynascan Corp.....	91
84 Brooks Radio & TV Corp.....	96-97
69 BSR USA Ltd.....	87
1 Castle TV Tuner Service, Inc.....	Cover II
15 Channellock, Inc.....	70
77 Chemtronics, Inc.....	86
14 Cleveland Institute of Electronics.....	28-31
65 Cook's Institute of Electronics Engineering.....	86
CREF, Division of the McGraw-Hill Continuing Education Co.....	18-21
12 Crown International.....	26
75 Delta Electronics.....	90
89 Delta Products, Inc.....	100
72 Dictaphone Corp.....	89
Dynascan Corp.....	71
96 Edmund Scientific Co.....	110
93 EL Instruments.....	102
95 Electronic Distributors, Inc.....	102
81 EICO, Electronic Instrument Co.....	95
EMC, Electronic Measurements Corp.....	91
91 Electrolube Corp.....	100
5 Electro-Voice, Inc.....	12
83 E.S. Enterprises.....	97
85 Fordham Radio Supply Co.....	98
2 Grantham School of Engineering.....	1
GTE Sylvania Electronic Components.....	32
100 Heath Co.....	74-77
73 Indiana Home Study Institute.....	90
17 International Crystal Mfg. Co.....	72
86 Jensen Tools & Alloys.....	98
18 Jerrold Electronics.....	73
82 Judson Research & Mfg. Co.....	96
80 Lafayette Electronics.....	93-94
97 Leader Instruments.....	Cover III
78 Lectrotech, Inc.....	92
99 Lee Electronic Labs.....	88
6 Micro-Instrumentation Telemetry Systems, Inc.....	13
76 Mountain West Alarm Systems.....	90
63 National Camera Supply Co.....	84
National Radio Institute.....	8-11
National Technical Schools.....	46-49
70 Nelson-Hershfield Electronics.....	89
13 Olson Electronics.....	27
66 PAlA Electronics, Inc.....	102
22 Pennwood Numechron.....	86
21 Perma-Power.....	81
PTS Electronics, Inc.....	80
20 Quam-Nichols.....	79
74 Quetrol.....	90
9 Radio Shack.....	17
RCA Institutes.....	64-67
10 RCA Parts & Accessories.....	22
64 RCA Technical Publications.....	85
Robins Industries, Inc.....	16
Rye Industries, Inc.....	92
11 Sams & Co., Howard W.....	23
62 Schober Organ.....	84
4 Shure Bros.....	7
8 Sony Corp. of America.....	15
68 Supersonic Electronics Co.....	87
61 Telematic.....	83
19 Telex.....	78
94 Tri-Star Corp.....	102
3 Tuner Service Corp.....	5
87 TV Tech Aids.....	98
90 Vero Electronics.....	100
98 Winegard.....	Cover IV
71 Workman Electronic Products, Inc.....	89
7 Xcelite.....	14
MARKET CENTER.....	103-109
105 ATV Research Corp.....	108
Babylon Electronics.....	105
Command Productions.....	108
106 Digi-Key.....	106
Fair Radio Sales.....	107
101 G.F. Electronics.....	103
107 H & R Electronics.....	107
102 JTM Associates.....	103
Lakeside Industries.....	108
Leeds Radio.....	107
104 Meshna Electronics, John Jr.....	105
103 Meshpaks.....	104
108 Solid State Sales.....	105
Southwest Technical Products.....	108
109 Southwest Technical Products.....	107
Surplus Center.....	106
Surplus Center.....	107
Sydmar Electronics.....	108
United Sales.....	107
Yeats Appliance Dolly Sales Co.....	108
SCHOOL DIRECTORY.....	108
Valparaiso Technical Institute.....	108

15W RMS HYBRID AUDIO AMPLIFIER—Panasonic—Freq. response 20Hz-100KHz. 1/2% dist. Price \$6.50 PPD. PACE ELECTRONIC PRODUCTS, Box 161, Ontario Center, NY 14520

HEATH IO-102 Oscilloscope \$110.00. HOWARD GRUBAUGH 1634 Kimbrough, Springfield, MO 65804

TRIPLETT # 603 FET VOM USED EXCELLENT CONDITION \$65.00. HEWLETT-PACKARD # 204C AUDIO OSCILLATOR EXC \$50.00 POSTPAID. ROLAND SINCLAIR, 879 Lenox Road, Brooklyn, NY 11203

BACKISSUE electronic magazines, books. List 25¢ BELL, 3890 Bayridge, West Vancouver, Canada

IC MANUAL listing more than 500 common digital IC's with pin connection diagrams, \$2.75. ELECTRONETICS-RE-1, P.O. Box 278, Cranbury, NJ 08512

IC PRICES SLASHED FACTORY FIRSTS

NATIONALLY KNOWN BRANDS	SATISFACTION GUARANTEED	DIGITAL TTL	
7400N	22¢	7453N	22¢
7401N	22¢	7454N	22¢
7402N	22¢	7472N	35¢
7403N	22¢	7473N	45¢
7404N	24¢	7474N	42¢
7410N	22¢	7475N	72¢
7420N	22¢	7476N	50¢
7430N	22¢	7486N	52¢
7440N	22¢	7490N	72¢
7441N	\$1.20	7492N	72¢
7442N	\$1.15	7493N	72¢
7447N	\$1.02	7495N	\$1.05
7451N	22¢	74107N	47¢
		74121N	51¢

5% OFF TTL IC PRICES AT 100 PCS TTL IC'S MIXED.

LINEAR INTEGRATED CIRCUITS

DIP or TO-5 709...38¢, 10/\$3.50, 710...38¢, 10/\$3.50, 741...40¢, 10/\$3.70, 748...43¢, 10/\$3.95 TO-5 only 723...90¢, 10/\$8.25, Dual 741 (558) TO-5 90¢, 10/\$8.25, Dual 741 (558) Mini-DIP 75¢, 10/\$6.75 LM 309K TO-3 \$2.25 5/\$10.00

GENERAL PURPOSE TRANSISTORS

2N5134 Si NPN or 2N5138 Si PNP, 15¢ 8/\$1.00 2N3055 Si NPN Power\$1.00 10/\$9.50

1 AMP SILICON SUBMINIATURE RECTIFIERS

1N4001 50 PIV, 1N4002 100 PIV, 1N4004 400 PIV 1N4005 600 PIV.....10/\$1.00, 100/\$7.50

SILICON SIGNAL DIODES

1N4148 (1N914 equiv.)20/\$1.00, 100/\$4.00

RTL INTEGRATED CIRCUITS

uL900, uL914 & uL923 Mix 5/\$1.00, 100/\$15.00

READOUT TUBES

5 Volt 7 Segment Readout Tube \$2.95. Counting and Display Kit (Readout Tube #7490+ 7475+7447) \$5.25, 3 Kits for \$15.00

1/2 WATT 10% RESISTORS

Pick Values 4¢ 25/75¢ 100/\$2.50 500/\$11.25 Complete Digital Data Book50¢ Linear Data Book50¢

Free Catalog—Large Quantity Discounts—Orders Less Than \$70.00 Add 25¢—Others Postpaid

DIGI-KEY PRICE PACESETTER FOR QUALITY IC'S

BOX 126H THIEF RIVER FALLS, MN56701

Circle 106 on reader service card

MEMORIES Semiconductors Free Flyer, UTI
POB 252, Waldwick, NJ 07463

THE GREATEST R&R ALBUM two years in compilation. Available only thru mail. All songs released in original master form. 19 songs inc Bopalena, House of Blue Lights, Strange Love etc. All songs are collectors items and stylistic landmarks in Rock and Roll. Send \$5.00 to **ALBUM** POB 1301, Studio City, CA 91604

JAPANESE new products monthly! \$1.00. Refundable. **DEERE**, 10639 Riverside, North Hollywood, CA

CB-SBE'S 23 channel mobile transceiver. All Crystals Supplied. Fully warranted. \$99.95 check or M.O. (Information on request) **CB RADIO EQUIPMENT**, P.O. Box 611, Fairfield, CT 06430

IGNITION, 250: 1 Coil, Ballast \$7.95. Free lists. **TRANSPARK**, Carlisle, MA 01741

B & K, sencor test equipment, discount prices. Free catalog and price sheet. **FORDHAM RADIO**, 265 East 149th Street, Bronx, NY 10451

CAPACITORS: 75mfd,6V, Tantalum, 5/\$1.00, 5,000/\$550.; 1000mfd, 50V, 2/\$1.00, 2,000/\$600.; 2000mfd, 25V, 2/\$1.00, 2,000/\$600.; More; Free Flyer. **OSBORN**, Box 1191, Flagstaff, AZ 86001

TUBE TESTERS MERCURY MODEL 204 Write: **BOB GREBER**, 10144 Dunbarton Dr., El Paso, TX 79925

FREE catalog New Electronic Devices! World's Smallest Transmitter \$19.95! Telephone Answerer \$49.50! Telephone Recording Device \$19.95! "Bug" Detector \$59.50! Many more! **SONIC DEVICES**, 69-29R Queens Blvd., NY 11377.

TAPE & RECORDERS

RENT 4-track open reel tapes—all major labels—3,000 different—free brochure. **STEREO-PARTI**, 55 St. James Drive, Santa Rosa, CA 95401

RENT Stereo tapes \$1.50 week postpaid. Catalog 25 cents, **TAPE LIBRARY**, Box 8126, Washington, DC 20024

ELECTRONICS ENGINEERING & INSTRUCTION

HIGH SCHOOL DIPLOMA for adults. Earn State Diploma. Accepted by Civil Service, business, colleges. Low cost. No tedious study. Money-back guarantee. **DETAILS: H-S PROGRAM**, Suite 2507, 1221 Avenue of Americas, New York, NY 10020

FM/AM DIGITAL CLOCK RADIO

7 seg. fluorescent display tubes, LSI package for clock logic, completely silent electronic operation. Internal power supply operates clock up to 20 minutes during power failures. Front set P.B. clock controls. Wake up to music or tone. Compact size, beautifully styled 115 V 60 cy. Prepaid U.S.A. New \$99.00 **EQUIPT** cab. alum. blk. wrnkl. shock mtd for TS-164/AR freq. mtr. 10"W x 7"H x 1 1/4"D overall. Hinged front door. Ideal for solid state devices. Prepaid U.S.A. New \$79.95

LEEDS RADIO CO
57RE WARREN ST. N.Y.C. N.Y. 10007

TRANSISTOR TESTER

"IN CIRCUIT"—Model 85
\$19.95 Prepaid

Places transistor into actual operation. Operates upon contact. Clear speaker tone—no visual observations to make. Tests transistors in or out of the circuit. Money back guarantee.

Extender
Cable
Included
with
Tester

UNITED SALES, DEPT. 8690
BRIGHTWOOD, WASHINGTON, D.C. 20011

DIODES

1N4001-3¢ ea
1N4003-6¢ ea
1N4004-8¢ ea
1N4005-10¢ ea
1N4006-12¢ ea
1N4007-15¢ ea

LINEAR IC'S

709 35¢ ea
741 70¢ ea

RESISTOR KITS

composition
1/4 watt 5%
mixed values
10 for \$1.00
specify low med or
high range of values

HIGH VOLTAGE DIODE

18KV 100 milliamp
(1N3055) \$6.50 ea
Bonus gift for orders
of \$5.00 or more

MAIL TO:

H & R Industries
PO BOX 413
TEWKSBURY MASS 01876

Circle 107 on reader service card

GOVERNMENT SURPLUS ELECTRONICS

R-388/URR RADIO RECEIVER — 550 KC
to 30.5 MHZ: 30 Bands—Used. Serviceable: \$375.00;
Checked: \$400.00
AN/URM 32 FREQUENCY METER — 125 KC
to 1000 MC in 3 Ranges—Used. Serviceable: \$150.00;
Checked: \$175.00
FR-4/U FREQUENCY METER — 100 KHZ to
20 KHZ. Used Serviceable: \$ 85.00;
Checked: \$110.00
FR-5/U FREQUENCY METER — 10 MHZ to
100 MHZ. Used Serviceable: \$ 80.00;
Checked: \$105.00
FR-6/U FREQUENCY METER — 100 MHZ to
500 MHZ. Used Serviceable: \$ 80.00;
Checked: \$105.00
FR-38/U FREQUENCY METER & COUNTER
— 10 HZ to 10 MHZ—Used. Serviceable: \$175.00;
Checked: \$200.00
With 325B Plug-In for 100—220 MHZ Extra: \$ 50.00
Prices F.O.B. Lima, O.—Dept. RE
SEND FOR BIG NEW CATALOG

FAIR RADIO SALES
1016 E. EUREKA, Box 1105, LIMA, OHIO 45802

Now Get **MUSIC ONLY** FM Programs

Convert ANY FM TUNER to receive uninterrupted commercial free music being broadcast by many stations.



New three transistor plus "Phase locked loop" IC circuit gives you perfect reception. No tuned circuits, or critical adjustments. The 1 1/2" x 4" circuit board is powered from the tuner supply. +9 to 12 Volts DC @ 10 Ma. required.

Kit Only
\$14.50
With Squeelch
\$19.50
Wired & Tested
\$25.00
With Squeelch
\$29.95
Plus postage
and insurance.
**THOUSANDS
SOLD**

Free list of FM stations with SCA authorizations included. (List alone \$.25)

Southwest Technical Products Corp.
BOX 32040 • SAN ANTONIO, TEXAS 78284

SPECIAL SALE CB-RADIO EQUIP'T

* **SURPLUS CENTER** is offering for a limited time only, Citizen's Brand radio equipment at a Very Special, Very Low price. Hurry, while supply is good! Famous Brand Name

Powerful, 5-Watt, 23-Channel, CB Walkie-Talkie

List Price \$149.95 Reg. Catalog \$109.90

Limited Sale*
\$99.95

(7 lbs.)



* (ITEM #M13-795-RE) - Hand held 23-channel transceiver has full legal (5-watts power) to give it plenty of punch for reliable, long range communications. Has all the features and power of the larger base/mobile units. You can use these where you can't get vehicles to go.

* All 23 crystals are furnished. Isolated chassis permits use in cars or trucks with 12-volt system. Operates on 10 "AA" cells (not furnished). Built-in 2 1/2" speaker/mike, 70" telescoping antenna, full controls. Jacks provided for external speaker, earphone, external mike, antenna, power source, battery charger. Carrying case with strap furnished. 10" x 3 1/2" x 2 1/4"

23-Channel, 5-Watt, CB Mobile Transceiver

(5 lbs.)

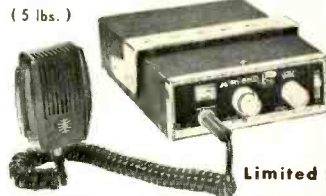

Limited Sale*

List Price \$139.95 Reg. Catalog \$109.95 **\$89.95**

* (ITEM #M13-870C-RE) - Professional 23-channel mobile CB transceiver with all crystals furnished. Full legal (5-watts) power gives long range, dependable radio communications with base station and other mobile units. Very compact, easy to install in trucks, autos, ATV's, etc. Mounting bracket furnished.

* Latest design, solid state circuitry. Crystal controlled transmit/receive frequencies and ceramic filter provide sharp, clear reception over long range. Built-in speaker. Microphone with coil cord and magnetic hanger furnished. Jacks provided for microphone, external speaker and external antenna. 8 1/2" x 6" x 2 1/4"

23-Channel, 5-Watt, CB Base Station Transceiver

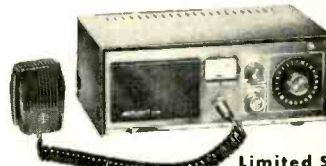

Limited Sale*

List Price \$149.95 Reg. Catalog \$109.90 **\$99.90**

* (ITEM #M13-891-RE) - Special savings on CB Base Station Transceiver ideal for Contractors, Construction Co's., Road Builders, etc. Full legal power (5-watts) gives you dependable radio contact with all your CB equipped vehicles in the field. Equipped with crystals for all 23 CB channels, none extra to buy! Latest design, solid state circuitry for trouble-free performance, long range, exceptional clarity.

* Operates on 110-VAC, equipped with complete controls, on-off-volume, illuminated channel selector, full variable squeelch, transmit/modulate indicator light. Built-in 4" x 2 1/2" dynamic speaker. Dynamic microphone with coil cord furnished. Jacks provided for microphone, external speaker, external antenna. 11" x 7 1/4" x 4 1/2". (10 lbs.)



All Items F.O.B. Lincoln, Nebr.
Order Direct From Ad. Money Back Guarantee.
SURPLUS CENTER
DEPT. RE-112, LINCOLN, NEBR. 68501

AVIATION ELECTRONICS TECHNICIAN—Prepare for exciting career in new field of "Avionics". Train at nation's largest aeronautical school. Indicate if eligible G. I. Benefits. **SPARTAN AIRSCHOOL**, International Airport, MN, Tulsa, OK 74151

SHORTCUTS To Success! Highly Effective, Profitable Short Courses. (75 Choices). Study At Home. Diploma Awarded. Our 27th Year. Free Literature. **CIEE-E**, Box 10634, Jackson, MS 39209.

TV TUNER REPAIRS—Complete Course Details. 12 Repair Tricks. Many Plans. Two Lessons, all for \$1. Refundable. **FRANK BOCEK**, Box 3236 (Enterprise), Redding, CA 96001

WANTED

WANTED: Old radios, tubes—24, 47, 80's; pre 40's. **M.E. SCOTT**, M.D., Box 3608, Radford, VA 24141

QUICK CASH . . . for Electronic EQUIPMENT, COMPONENTS, unused TUBES. Send list now! **BARRY**, 512 Broadway, New York, NY 10012, 212 Walker 5-7000

TUBES

RECEIVING & INDUSTRIAL TUBES, TRANSISTORS, All Brands—Biggest Discounts. Technicians, Hobbyists, Experimenters—Request **FREE** Giant Catalog and **SAVE!** **ZALYTRON**, 469 Jericho Turnpike, Mineola, NY 11501

TUBES Receiving Factory Boxed. Low Prices, Free Price List. **TRANSELETRONIC INC.** 1306 40th Street, Brooklyn, N.Y. 11218. Telephone 212-633-2800.

SAVE money on parts and transmitting-receiving tubes, foreign-domestic. Send 25¢ for Giant Catalog. Refunded first order. **UNITED RADIO COMPANY**, 56-R Ferry Street, Newark, NJ 07105

TUBES-IEC 70% DISC. 5 FREE WITH EA. 50. SENCORE, EICO, MALLORY, HEP, SHURE. ALSO CARTRIDGES, NEEDLES LOWEST PRICES. FULL GUARANTEE. M & K ELEC. DIST., 135-33 Northern BLVD., NYC 11354

RADIO and TV Tubes 36¢ each. One year guaranteed. Plus many unusual electronic bargains. Free Catalog. **CORNELL** 4217-E University, San Diego, CA 92105

XENON STROBELIGHT FLASHTUBES FT106 50W \$2.50, 2/\$4.00, 10/\$16.00, 100/\$125.00. Plans 50¢. MINDLIGHT, P.O. Box 2846RE, Van Nuys, CA 91404

Technical Excellence in Electronics.

On our small, friendly campus the emphasis is on Living as well as Learning. Extra-curricular social activities, student clubs, a student operated radio station, student government, norm dormitory and a full sports program help provide a world of your own in which to prepare for tomorrow. Associate Degree in Engineering Electronics. B.S. obtainable. G.I. approved.



VALPARAISO TECHNICAL INSTITUTE
Dept. C, Yellowstone Trail, Valparaiso, Indiana 46383

BUILD A "SPACE-AGE" TV CAMERA!!

ONLY KNOWN SOLID-STATE CAMERA IN KIT FORM!
Also available factory assembled. Ideal for experiments, industry, education, etc. High quality performance based by over seven years of lab and field testing. Fully Guaranteed. Completely self-contained. Connects to any TV set without modification. Easy-to-follow assembly manual. Model XT-1A, Series D complete with vidicon \$149.00 PP anywhere in USA & Canada (less vidicon tube \$16.95 pp). Many other kits, parts and plans also available.

PHONE or WRITE for CATALOG...DIAL 402-987-3771
BOX 453-RE **ATV Research** DAKOTA CITY, NEBR. 58731

REBUILD YOUR OWN PICTURE TUBES?

With Lakeside Industries precision equipment, you can rebuild any picture tube!

For complete details, send name, address, zip code to:

LAKESIDE INDUSTRIES
3520 W. Fullerton Ave.
Chicago, Ill. 60647
Phone: 312-342-3399



YEATS appliance dollies

MOVE 'EM EASY with a **YEATS dolly**



DeLuxe Model No. 14 \$89.50

ORDER YOURS TODAY! FREE illustrated brochure

Yeats Appliance Dolly Sales Co.
1301 W. FOND DU LAC AVE.
MILWAUKEE, WIS. 53205



F.C.C. EXAM MANUAL

The Original Test-Answers exam manual that prepares you at home for FCC First and Second class licenses. Includes Updated multiple choice tests and key Schematic diagrams. PLUS - "Self-Study Ability Test." -- ONLY: \$9.95 Postpaid

COMMAND PRODUCTIONS P.O. BOX 26348 -- E
RADIO ENGINEERING DIVISION SAN FRANCISCO, CALIF. 94126



NOW build your own Capacitor Discharge Ignition System for as little as \$11.45! Circuit diagram included with special ignition transformer.

TR-200 transformer
6 or 12 volts 11.45

Complete COMPAC KIT
6 or 12 volts 25.95
(as described in

POPULAR ELECTRONICS—Nov. 1966)
FREE LITERATURE on all SYDMUR "CD" Systems.

SYDMUR—1268 E. 12 St.,
Brooklyn, N.Y. 11230

TEST EQUIPMENT SPECIALS

- (used in good condition)
- Tektronix 545A scopes with CA plug-ins \$800
- STABILISE 15 KVA 95-135V line regulator \$250
- Power Design 3240, 1-32V at 4A power supplies \$95
- Power Design 1210, 1-12V at 10A power supplies \$95
- Dumont 304A scopes \$95
- Tektronix 531 scopes with B or K plug-ins \$475
- HP 521C counters \$125
- HP 400D voltmeters \$95
- Ballantine 314 voltmeters \$95

TRANSISTOR SPECIALS

2N965 PNP 6E TO-18 .15W 7V .1A 300MHZ 40Hte 5/\$1.00	2N1605 NPN 6E TO-5 .15W 24V .1A 14MHZ 125 5/\$1.00
2N2360 PNP 6E TO-33 .06W 20V .05A 980 32 \$5.50	2N5324 PNP 6E TO-3 60W 250V 10A 20 35 \$1.50
2N1015D NPN SI TO-82 150W 200V 7.5A .025 10 \$1.45	2N2015 NPN SI TO-36 150W 50V 10A .012 26 \$1.45
2N3584 NPN SI TO-66 35W 250V 2A 10 100 \$1.50	2N3724 NPN SI TO-5 .8W 30V 1A 250 60 3/\$1.00
2N3772 NPN SI TO-3 150W 60V 30A .2 30 \$1.25	2N5296* NPN SI TO-220 36W 40V 4A .8 60 \$5.50
2N6109* PNP SI TO-220 36W 40V 4A .8 60 \$5.50	

*Match pair push pull amplifier

Analog Devices regulated power supplies have been designed to provide complementary power for Operational Amplifiers, Function Modules, A-D and D. A. Converters and Digital Logic. The supplies are completely self contained. Epoxy encapsulation provides properties close to a true hermetic seal.

Model	SE904	SE902	SE 12-60	Full Wave Bridges
Output Voltage (VDC)	±15	±15	±12	PRV 2A 6A
Output Current (MA)	50	100	60	200 .90 1.20
Price	\$18.95	\$26.95	\$18.95	400 1.10 1.40
				600 1.25 1.60

NE 565 Phase lock loops \$3.50

SEVEN SEGMENT COUNTER KIT

Consisting of 7 segment read-out driven by 5 volts, having 1/2" display, and a 7447 decoder and 7490 decade counter \$7.50

- 2N3819 FET \$4.5
- TIS43 UJT \$5.0
- PROGRAMMABLE UJT's similar to D13T with data sheet \$7.5
- VARIABLE CAPACITANCE DIODES, (similar to 1N5463A) used to tune VHF, Color TV & FM broadcast sets \$9.5
- ER900 TRIGGER DIODES. These bidirectional trigger diodes are one of the best and cheapest methods to trigger SCR's and triacs .4/\$1.00
- FLV 100 Visible LED \$65
- GaAs IR LED \$65
- MRD 14B photo darlington \$65
- 2N3055 7 amp NPN silicon power transistor 115 Vce \$1.00
- 1/4" reed relay 6/\$1.00
- 1N4886 25-40W Power varactor \$4.95

TRIACS

PRV	1A	10A	15A	20A*
100	.40	.70	1.00	1.20
200	.70	1.10	1.50	1.60
300	.90	1.35	1.90	2.00
400	1.00	1.60	2.70	2.40
500	1.50	2.00	3.20	2.80

*Press fit

TANTULUM CAPACITORS

- 4.7 MFD at 20V \$5/\$1.00
- 10 MFD at 20V \$4/\$1.00
- 4.7 MFD at 100V \$50
- 10 MFD at 100V \$75
- 200 PRV 15A full wave rectifier \$9.5

TTL IC SERIES

7400—.25	7474—.60
7401—.25	7475—.80
7402—.25	7476—1.00
7404—.27	7480—.75
7410—.25	7481—1.25
7413—.75	7483—1.20
7420—.25	7486—.57
7430—.25	7490—.79
7440—.25	7492—.80
7441—1.30	7493—.75
7447—1.15	7495—.75
7450—.25	74107—.85
7460—.25	74121—.55
7472—.50	74192—1.92
	8570—1.50
7473—.50	8590—1.50

- 14 Pin DIP sockets \$3/\$1.00
- 16 Pin DIP sockets \$60

MINIATURE TRIM POTS

- 500ohm, 10K, 20K, 25K \$75
- 50K \$3/\$2.00

Silicon Power Rectifiers

PRV	1A	3A	12A	50A
100	.06	.09	.24	.90
200	.07	.12	.20	1.25
400	.09	.16	.35	1.50
600	.11	.20	.50	1.80
800	.15	.28	.70	2.30
1000	.20	.35	.90	2.75

NIXIE TUBES

Similar to Raytheon 8650 long life tubes, with socket & data sheet \$2.25

DECADE COUNTER KIT

CONSISTING OF:
1—NIXIE TUBE and SOCKET
1—7490 1—7475 1—7441
Special priced at \$4.75

Miniature 7 segment cold cathode neon readouts
MG19F \$2.85

LINEAR CIRCUITS

- 709C operational Amp \$5.50
- 741 operational Amp \$5.50
- SE 501 Video Amp \$1.00
- 748 Adjust 741 \$95
- Dual 709 \$1.39
- 723 Regulator \$75
- TVR 2002 high power 723 \$1.00

Silicon Control Rectifiers

PRV	6A	10A	20A	70A
50	.25	.32		
100	.30	.45	1.00	3.50
200	.50	.75	1.25	6.50
300	.60	.90	1.50	
400	.70	1.10	1.75	9.50
500	.80	1.25	2.00	
600	.90	1.40	2.25	11.00

Terms: FOB Cambridge, Mass. Send check or Money Order. Include Postage. Average Wt. per package 1/2 lb. No. C.O.D.'s. Minimum Order \$3.00

Send for our fall catalog featuring Transistors and Rectifiers; 325 Elm St., Cambridge, Mass.

OLID

Post Office Box 74D

TATE

Somerville, Mass. 02143

ALES

Tel. (617) 547-4005

Circle 108 on reader service card

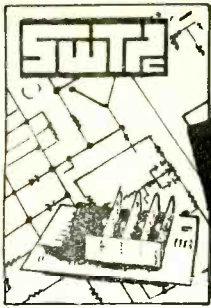

FREE

Southwest Technical Products Catalog of Unique Kits

Tired of the same old projects? Ready for something new and different? Your free Southwest Technical Products catalog describes almost 50 of our unique reasonable priced kits. Save up to 50% over the cost of comparable kits. Amplifiers, preamps, color organs, digital readout systems and more. Send for your free copy now.

Function Generator

**Sine-Square
Pulse-Triangle
and Ramp Waveforms
1.0 Hz to 1.0 MHz**



Ask anyone who has been able to afford one. A function generator is one of the handiest signal generators you can own. You get five different waveforms that may be used to test TV, radio, hi-fi, servo, digital logic and many other systems. Output level is 2.5 Volts P-P maximum at 70 Ohms source impedance. Choice of AC, or DC coupled output, with adjustable offset when DC coupled.

Plug together construction and three printed circuit boards make construction easy. 5¼ x 6¼ x 2½ impact plastic case. Get yours now at our special low introductory price.

Kit # FG-1. 3 lbs. \$39.95

NEW— Digital Tachometer

**400 to 9,990 RPM
4 Digit-LED Readout
Work with all 4, 6
or 8 cylinder engines**

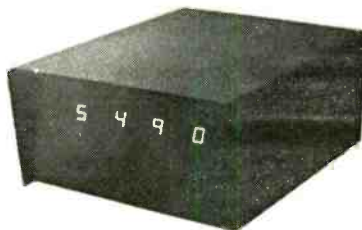

Something really different to add to your car. This beautiful little instrument reads out your engine RPM directly on a bright red light emitting diode display. Phase locked loop circuit makes possible a four digit readout that is accurate to ±2%.

Plug together construction simplifies construction. Only +12 Volts and distributor point connections required on the engine. 4½ x 2½ x 7 black vinyl covered metal case.

Kit # TACH-1. 3.0 lbs. \$79.50

Short Proof Power Supply

**0-32 Volts • 0-2 Amps
Dual Meters**



Continuous adjustment of voltage and current. Regulated low ripple output. Compare the voltage and current output with others at twice our low price.

Brushed gold front panel, black vinyl covered metal case. 9 x 7 x 3

Kit #143. 8 lbs. \$39.50

Digital Microlab Logic

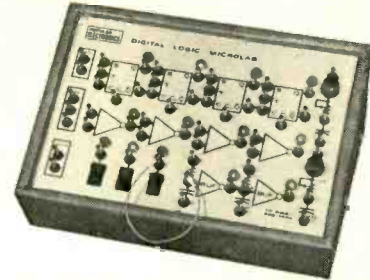

The ideal way to check out your digital system designs, or to learn how digital logic works. This versatile low cost system contains four flip-flops, four gates, two buffers and three data switch system that can be used to make up hundreds of experiments and basic logic circuits. Indicator lights show the state at each output. Connections are made with simple clip-on leads that are easy to attach and remove. The instrument cannot be damaged by any combination of external connections, no matter how wrong. Connect more than one together for complex experiments.

Kit is complete with AC supply and wood grain finish outer case. 10 x 7 x 3. Learn the basics of digital electronics by yourself using our twenty-seven experiment lab manual written for use with the Microlab.

Kit #DLM 4 lbs. \$29.95
Microlab lab Manual \$ 1.95

Two Great Color Organs for your Holiday Decorations

PSYCHEDELIA I and now PSYCHEDELIA II

The best color organs available. Both of these unique color organ systems have four channel output. You can use up to 750 Watts of lamps per channel for a total of over 2.5 Kilowatts of light from each color organ circuit. Transformer isolated inputs can be safely driven from any sound system, or stereo system speaker connection.

Psychedelia I is a filter type color organ, using the "classical" filter and amplitude detector system to generate four channels. Op-amp active filters are used in our circuit along with our exclusive ramp triggering system to give fast proportional light response. Automatic level control allows the circuit to compensate for up to 40 dB variation in sound system level without any need to readjust the color organ sensitivity.

Psychedelia II is a digital color organ. This new and different approach to color organ design uses a sampling system and counting techniques to separate the sound input into four light channels. This type system tends to produce a very active flashing type display which many prefer. It also is more random and does not follow the music in quite as obvious a way as a filter type color organ.

Kit #QX-1 or QX-11. 4 lbs. \$44.95
Both kits less display of any kind.
Bookshelf display semikit. \$26.50

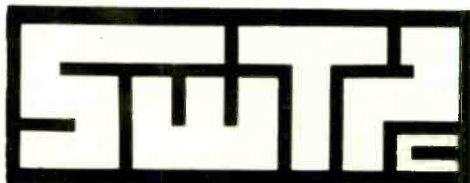

SOUTHWEST TECHNICAL PRODUCTS CORPORATION

219 W. RHAPSODY, SAN ANTONIO, TEXAS 78216

Circle 109 on reader service card

Leader Multiplex / Stereo Generator

**WITH STABILITY
LIKE THIS,
WHAT ELSE
DO YOU
NEED?**

**LSG-231
\$229.95**



**The more you see...
the more you believe.**

Check multiplex alignment, balance and separation with "never before stability"! The LSG-231 is so precise, so accurate, you may not want to use a scope! That's because this compact, easy-to-operate, Multiplex/Stereo Generator has an audio signal frequency of 1KHz, with $\pm 1\%$ accuracy, and 50dB signal separation. The 19KHz pilot signal frequency has $\pm 2\text{Hz}$ accuracy. Output voltage is 0 to 3Vrms (cont. variable).

Whether you use it in the field, on the bench, or in a lab, this is the generator with all the features you want for fast, easy service of all multiplex receivers and tuners. Complete with handy tilt-stand, it's another reliable, rugged instrument from Leader.

Leader

INSTRUMENTS CORP.

37 · 27 Twenty-Seventh Street,
Long Island City, N.Y. 11101
(212) 729-7410

Circle 97 on reader service card

FROM WINEGARD...THE GREATEST BROADBAND AMPLIFIER VALUE EVER!

Winegard
Ultraplex
Modular
Broadband
Amplifiers
with
Highest
Input
and
Output
Capability.

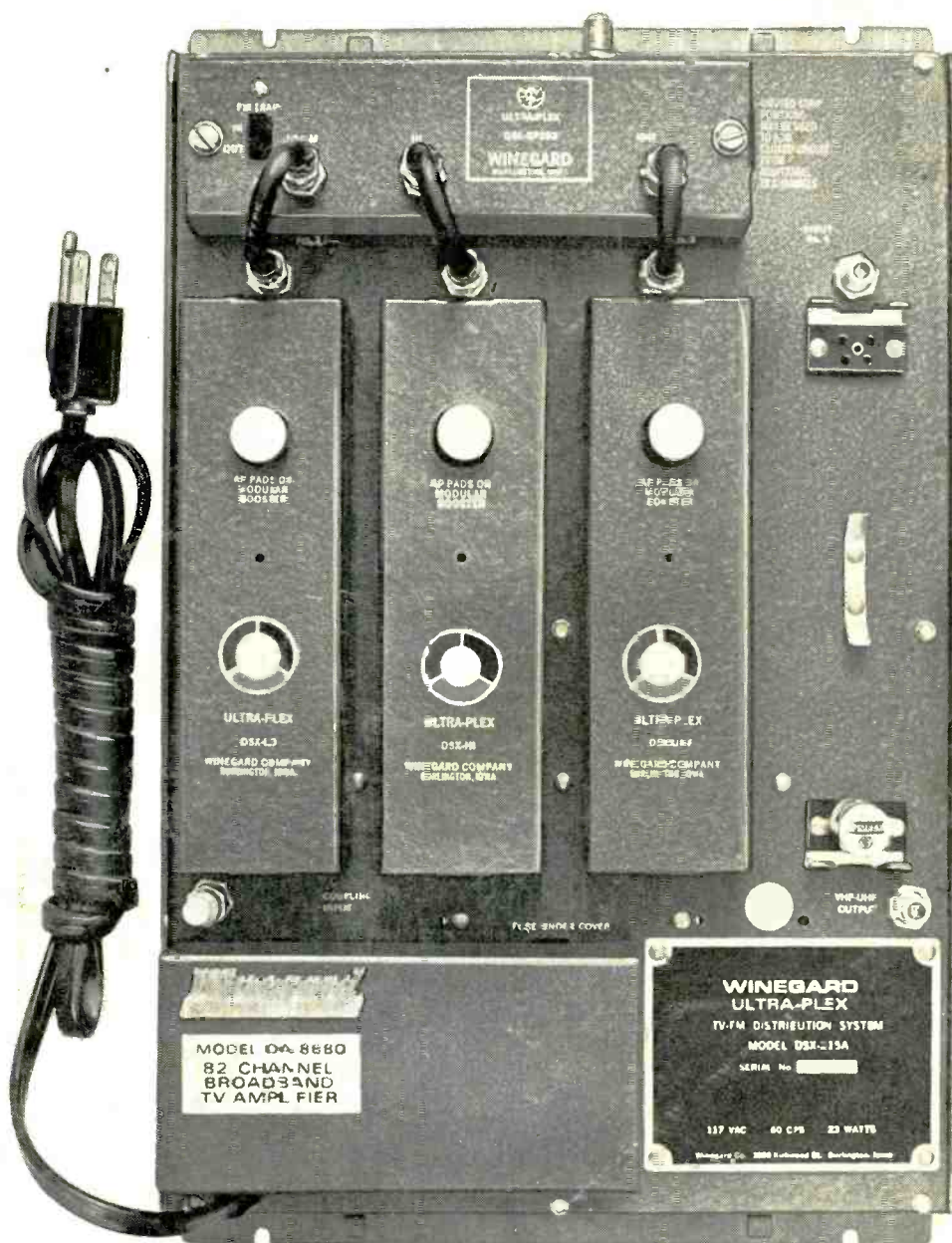

- * 5 models with unlimited flexibility
- * VHF, UHF or any combination
- * sub-channel and closed circuit optional
- * electronically regulated and filtered power supply with heavy duty transformer
- * choice of single or separate band antennas, plus switch-selectable FM trap on 3 largest models
- * modular boosters available for 15 db additional gain in weak signal areas

Now you can install a higher-performance system for sharper - much sharper - MATV pictures! Check your distributor or write Winegard.



WINEGARD
TELEVISION SYSTEMS

Winegard Company, 3000 Kirkwood Street, Burlington, Iowa 52601

Circle 98 on reader service card